

PREFACE	4
CHAPTER 1 INSTALLATION OF EV5000	7
1.1 INSTALLING EV5000	7
1.2 INTERFACE DIAGRAM.....	9
CHAPTER 2 CREATING A SIMPLE PROJECT	14
2.1 NEW AN EMPTY PROJECT.....	14
2.2 ADDING A SWITCH COMPONENT	20
CHAPTER 3 DESCRIPTION OF THE EV5000 SOFTWARE	26
3.1 USER INTERFACE OF EV5000	26
3.2 GRAPH ELEMENT WINDOW	57
3.3 PROJECT FILE WINDOW.....	62
3.4 PROJECT WINDOW AND PROJECT CONSTRUCT WINDOW:.....	63
3.5 COMPILE INFORMATION WINDOW	65
3.6 COMPONENT LIST WINDOW	65
3.7 OFFLINE SIMULATION	66
3.8 ONLINE SIMULATION.....	67
3.9 DOWNLOAD.....	69
CHAPTER 4 CONFIGURATION WINDOWS	85
4.1 WINDOW TYPE.....	85
4.2 WINDOW PROPERTIES	88
4.3 CREATING A WINDOW	91
4.4 OPENING A WINDOW	91
4.5 DELETING A WINDOW	92
4.6 EXAMPLES FOR WINDOWS.....	92
4.7 WINDOW-RELATED COMPONENTS	102
CHAPTER 5 DESIGN WITH EV5000, SOME BASIC KNOWLEDGE	103
5.1 PARTS	103
5.2 ABOUT PART ID	104
5.3 ADDITIONAL NOTE (DESCRIPTION)	105
5.4 INPUT/OUTPUT ADDRESS OF PLC.....	105
5.5 VECTOR GRAPH	107
5.6 BITMAP GRAPHICS.....	113
5.7 CREATING A LABEL	119
5.8 TASKBAR AND TASK BUTTONS	120
CHAPTER 6 COMPONENTS(PARTS)	123
6.1 INDICATOR LAMP.....	124
6.2 BIT SETTING COMPONENT	127
6.3 SWITCH.....	130
6.4 WORD SETTING.....	131
6.5 MULTI-STATE DISPLAY.....	134
6.6 MULTI-STATE SWITCH	136
6.7 XY PLOT	138
6.8 MOVING COMPONENT	141
6.9 ANIMATION	145
6.10 NUMBER INPUT.....	149
6.11 NUMERIC DISPLAY	155
6.12 TEXT INPUT.....	157
6.13 TEXT DISPLAY.....	165
6.14 BAR GRAPH.....	166
6.15 METER.....	169

6.16 INDIRECT WINDOW	171
6.17 DIRECT WINDOW	175
6.18 ALARM INFORMATION LOGON	176
6.19 ALARM DISPLAY	178
6.20 TREND CURVE	180
6.21 RECIPE DATA	193
6.22 EVENT ENTRY (EVENT INFORMATION LOGON).....	193
6.23 EVENT DISPLAY	197
6.24 ALARM BAR.....	204
6.25 OSCILLOSCOPE	207
6.26 SCALE	211
6.27 SCROLL BAR.....	212
6.28 MESSAGE BOARD (NOTE PAD).....	215
6.29 FUNCTION KEY	220
6.30 TIMER.....	230
6.31 VIDEO COMPONENTS (ONLY APPLICABLE TO MT5600T/MT5700T)	236
6.32 BITMAP COMPONENT	241
6.33 VECTOGRAM COMPONENT	241
6.34 TEXT LIBRARY	242
6.35 ADDRESS TAG	245
6.36 PLC CONTROL	248
6.37 ABOUT OVERLAPPING OF COMPONENTS	253
CHAPTER 7 SYSTEM PARAMETERS	259
7.1 HMI.....	259
7.2 TASKBAR.....	260
7.3 HMI EXTEND ATTRIBUTIONS.....	262
7.4 PRINT SETTINGS	265
7.5 COM SETTINGS	266
7.6 PLC STATION NO.	269
CHAPTER 8 RECIPE DATA.....	270
8.1 CREATING A RECIPE DATA TRANSMISSION COMPONENT	270
8.2 RECIPE MEMORY	271
8.3 UPLOADING/DOWNLOADING OF RECIPE DATA BETWEEN TOUCH SCREEN AND PLC	278
CHAPTER 9 MACRO CODE	287
9.1 GETTING STARTED: A SIMPLE MACRO TEMPLATE.....	287
9.2 OPERATING PRINCIPLES OF MACRO TEMPLATE AD READ/WRITE VARIABLE.....	292
9.3 TRIGGERING OF MACRO	294
9.4 EXAMPLES	295
CHAPTER 10 PRINT.....	302
10.1 FUNCTION KEY	302
10.2 SCREEN PRINTOUT	303
10.3 REPORT OUTPUT	304
10.4 EVENT PRINTOUT	305
10.5 PRINTING FAILURE	306
CHAPTER 11 RESERVED REGISTER ADDRESSES OF THE SYSTEM.....	308
11.1 LOCAL BIT (LB) REGISTERS RESERVED.....	308
11.2 LOCAL WORD (LW) REGISTERS RESERVED	313
11.3 NONVOLATILE LOCAL WORD (LW10000~10256)	315
CHAPTER 12 SECURITY LEVEL.....	318
CHAPTER 13 SERIAL COMMUNICATION.....	332
13.1 SERIAL COMMUNICATION	332

13.2 RS-232.....	333
13.3 RS-422.....	335
13.4 RS-485.....	337
CHAPTER 14 CONNECTION OF EVIEW MT5000/4000 WITH COMMON PLCS	340
14.1 OMRON PLC	340
14.2 MITSUBISHI PLC	350
14.3 KOYO PLC.....	359
14.4 ALLEN-BRADLEY PLC	366
14.5 MODICON PLC	371
14.6 FACON PLC.....	375
14.7 SIEMENS PLC.....	378
14.8 LG PLC	383
14.9 MATSUSHITA PLC.....	388
14.10 DELTA PLC	391
14.11 MODBUS RTU CONTROLLER	393
14.12 MODBUS ASCII CONTROLLER.....	395
14.13 VIGOR PLC	398
14.14 EMERSON PLC	400
14.15 KEYENCE PLC	402
14.16 OEMAX PLC	405
14.17 ABB (07KR51) PLC	407
14.18 EVIEW MASTER AND EVIEW SLAVE (MASTER/SLAVE PROTOCOL CONNECTION)	409
14.19 BAUMULLER CONTROLLER	410
14.20 KINCO ECOSTEP CONTROLLER	411
CHAPTER 15 OPERATION INSTRUCTIONS FOR EVMANAGER	414
15.1 INTRODUCTION TO EVMANAGER.....	414
15.2 DOWNLOAD OPERATE.....	415
15.3 UPLOAD OPERATE.....	421
15.4 SYSTEM OPERATE.....	424
CHAPTER 16 USE OF SETUP.....	427
CHAPTER 17 NETWORKING OF MT5000 SERIES TOUCH SCREENS.....	429
17.1 NETWORKING	429
17.2 MUTUAL DOWNLOAD BETWEEN DIFFERENT TOUCH SCREENS	441
APPENDIX I SYSTEM MESSAGES	442
MT5000/4000 SYSTEM MESSAGES TABLE.....	442
APPENDIX II TROUBLESHOOTING.....	443
APPENDIX III HARDWARE OVERVIEW	446
INSTALLATION OF MT5000 SERIES TOUCH SCREENS	446
1. INSTALLATION OVERVIEW.....	446
2. INSTALLATION INSTRUCTIONS.....	446
3. PROGRAMMING SOFTWARE	455
4. PRODUCT SPECIFICATIONS	456

Preface

Thank you for buying MT5000 and MT4000 series industrial embedded Human-Machine Interface (hereinafter referred to as “HMI”) products.

HMI is a two-way communication bridge between an operator and a machine. A user can combine characters, buttons, figures and numerals to process or monitor, manage and deal with the multifunctional display screen which may display ever-changing information anytime. With the rapid development of the mechanical equipment, old operation interfaces can only be operated by skilled service-trained professionals, and furthermore, the operation is difficult and the working efficiency can not be improved. However, the application of the HMI can make clear indication and inform the operator of the current conditions of the machine so that the operation will be simple and visual, misoperations can be reduced, and even a new operator can operate the entire machine easily. Furthermore, the use of the HMI can also implement standard and simple cabling of a machine, and meanwhile the number of I/O points necessary for the PLC (Programmable Logic Controller) can be reduced, and the added value of the entire set of equipment can be relatively improved due to the compact size and high performance of the control panel at the same time when the production cost is reduced.

As a new kind of HMI, touch screen has attracted wide attention since its emergence. With its simplicity, operational convenience, powerful function and excellent stability, it is applicable to industrial environments, and even can find wide application in our daily life. For example, automatic parking equipment, automatic car washer, roller-bridge lifting and hoisting control, production line monitoring & control, or even intelligent building management, conference room audible/visual control, and temperature adjustment.

With the rapid development of the science and technology, more and more machines and field operations need the use of HMIs. The powerful function of PLC and the complicated data processing also call for the emergence of a convenient matching HMI. The development of touch screen is undoubtedly a great innovation in the automation field in the 21st century.

MT5000 and MT4000 are a brand-new generation of industrial embedded touch screen HMIs, with the following features:

- Embedded RISC CPU featuring high speed and low power consumption
- Embedded operating system
- Higher speed and more smooth operation
- Richer color and finer display
- The MT5000 fully supports such high-speed interfaces as the Ethernet and USB interfaces, and the MT4000 supports high-speed USB interfaces.
- More resources, and lower price

- Simple, easy to use, stable and reliable.

The MT5000 and MT4000 series HMIs have the following new features:

- The 65536-color display mode gives richer color to the touch screen, with incomparable display effect.
- With the application of powerful 200 ~ 400 MHz 32-bit RISC processor, the MT5000 and MT4000 have higher processing speed.
- The product supports simultaneous communications of multiple serial ports. The two serial ports of the standard hardware can use different protocols to connect different controllers at the same time.
- The MT5000 completely supports the Ethernet communications function, and multiple touch screens can be networked at will.
- The function of image file support is added, supporting the import of images in such formats as 24-bit bitmap, JPEG and GIF.
- Standard C-language macrocodes can be triggered in multiple modes, featuring powerful function, high flexibility and easy operation.
- Powerful timer function
- USB download greatly accelerates the download speed in user configuration.
- The communication capability of the USB ports is increased, so that programs can be downloaded through the USB ports.
- SPC (Stored Programmable Controlled) contrast and brightness: The contrast and brightness are adjusted through the Local Bit (LB).
- User-defined start interface: The user can customize a start LOGO interface.
- Supporting all fonts of the Windows platform;
- Supporting the drawing of any arcs and sector diagrams;
- Supporting direct connection with most mainstream PLCs, the MT5000 and MT4000 will have wider market and application prospect.
- With the simple, convenient and powerful EV5000 configuration software, the user can master its design method and design first-class works at the fastest speed.

Before using the MT5000 and MT4000 series touch screens, please read this manual carefully to ensure correct operation of the equipment and the safety of the user and equipment so that the touch screens can achieve the best operation effect. In the meantime, please keep the manual well for future references in commissioning, maintenance, examination and repair. If you have any doubts or problems during the use of the product, please feel free to contact the Technical Support Department of our company without delay.

Our product will surely better meet your requirements, and the application of our product will boost your business career. Any suggestions and comments on our products are welcome. If you have

any suggestions, comments or complaints on our product, please contact us immediately at any time (we provide 7 days * 24 hours service), and we will make quick and satisfactory response as soon as possible.

The following sections present a detailed description of our product.

Chapter 1 Installation of EV5000

1.1 Installing EV5000

- **Minimum Computer Hardware Requirement (Recommended Configuration):**

CPU: INTEL Pentium II or better

Memory: 128 MB or higher (512 MB is recommended)

Hard disk: 2.5 GB or above, at least a free disk space over 100 MB (40G or above is recommended)

CD ROM: One 4X CD-ROM optical drive

Monitor: Supporting monitor with a resolution of 800*600, and 16-bit color or above (recommended: 1024×768, 32-bit true color or above)

Mouse and keypad: One for each

RS-232 COM port: At least one port available for serial communications between PC and the touch panel

USB port: USB A-type port (1.1 or 2.0)

- **Operating system:**

Windows 2000 (with SP4)/ Windows XP (with SP2)

- **Installation procedure:**

- 1 After Inserting the EV5000 setup disk into the optical drive, the setup program will automatically run, or you may manually run the **Setup.exe** file under the root directory of the CD.

The following interface appears:

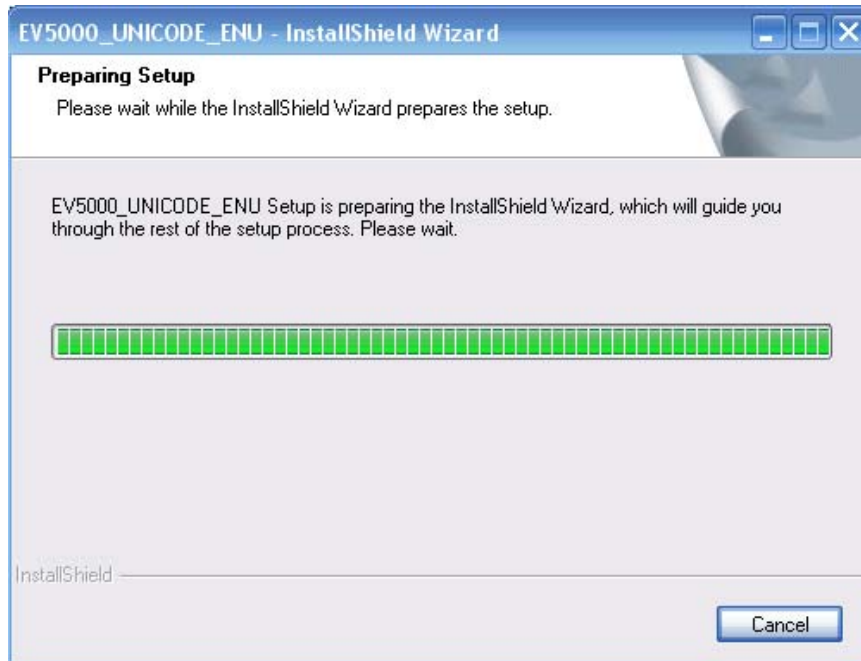

- 2 2 Follow the instructions of the InstallShield Wizard, click the *Next* button, enter the user's information, as shown in the following figure:

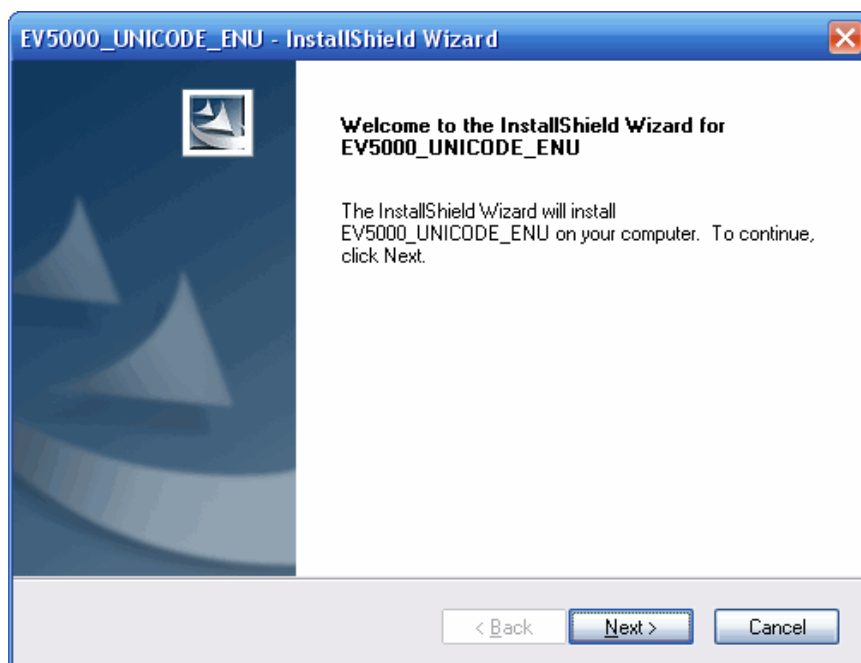

- 3 Click **Finish** to complete the installation.
- 4 To run the program, find the executable program under the directory of **Start → Programs → Stepservo → ev5000**.



1.2 Interface Diagram

The COM0/COM1 ports in MT5000 and MT4000 can be connected to a PC or a PLC. The MT5000 and MT4000 have very powerful communication capability. The MT5000 provides one Ethernet interface (the MT4000 does not have any Ethernet interface), one USB interface, one print interface, and two serial ports). Therefore, the MT5000 and MT4000 are capable of communications with most devices with communication capabilities. Thus, it can be seen that the MT5000 and MT4000 have wide applications. These interfaces will be described one by one in the following sections:

1.2.1 Serial Ports

Presently the MT5000/4000 has two serial ports, marked COM0 and COM1.

The two ports are respectively male and female connectors for the convenience of differentiation.

The difference between their pins lies in PIN 7 and PIN 8.

COM0 is a 9-pin male connector, with the pinout definition as follows:

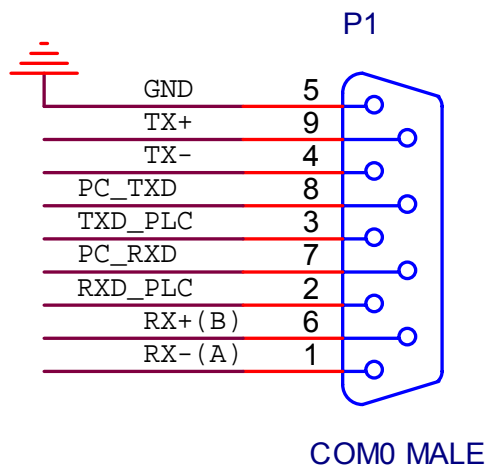

PC232/PLC232-NO HARDWARE CONTROL/485/422

COM1 is a 9-pin female connector, with the pinout as follows. Its difference from COM0 is that its PC_RXD and PC_TXD are replaced with TRS_PLC and CTS_PLC hardware control connected to PLC 232.

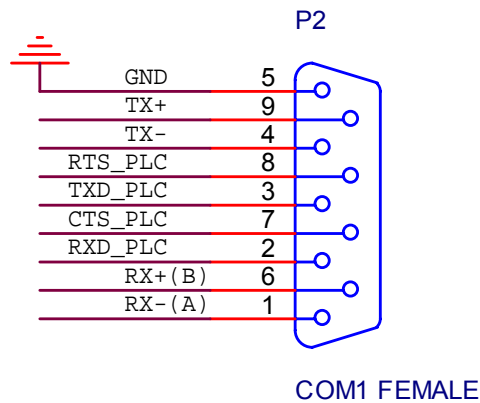

PLC232-HARDWARE CONTROL/485/422

1.2.2 Ethernet Interface

The MT5000 (MT4000 does not have any Ethernet interface) has an adaptive 10M/100M network interface which can implement such functions as program download, online simulation and interconnection of multiple devices.

With the use of the Ethernet, we can conduct the following operations:

- (1) Downloading programs from a PC to the HMI: The download is much faster than download through an RS232 or USB port;
- (2) Implementing networking and interconnection of multiple HMIs;
- (3) Implementing communications between the HMI and field equipment.

The settings of the Ethernet interface are as follows:

(1) In the **Project Window**, double click the HMI icon, and the following dialog box appears:

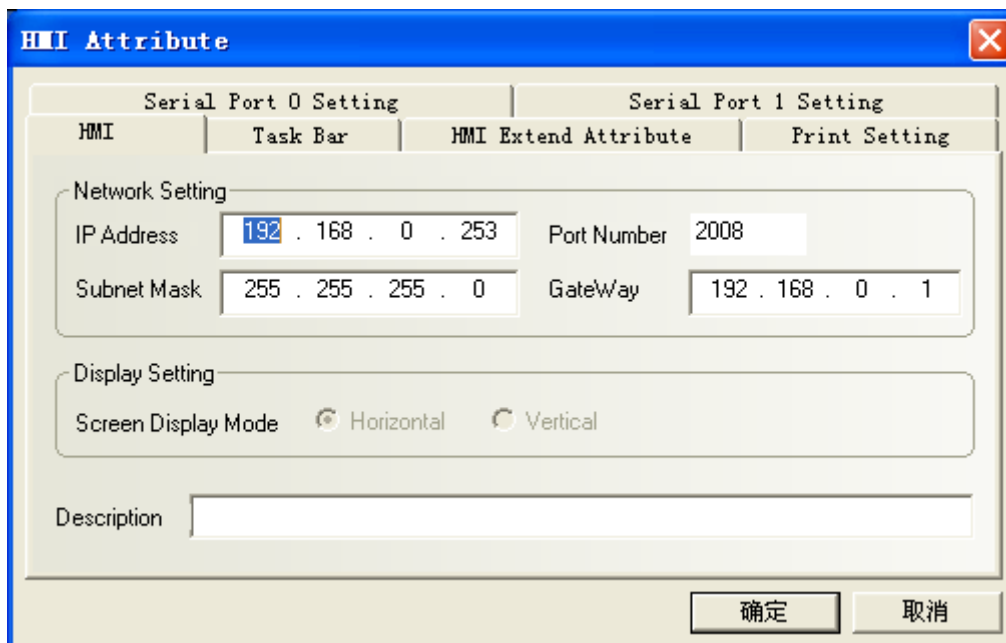

(2) Set the **IP Address** and **Port Number**. Note that the IP addresses over the same network should not be the same.

(3) After saving the compilation, download the IP address of the HMI through the serial port or

USB port. After download, the IP address on the screen will change to the IP address set in the above figure.

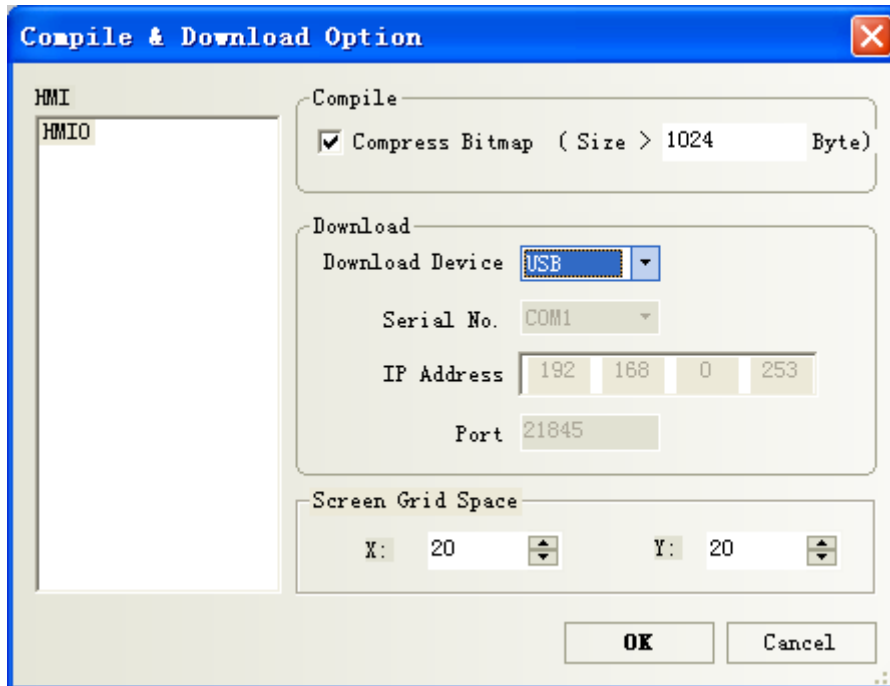

(4) If the Ethernet interface is used to download the program, the IP address should be set to be different from that of the PC. To modify the IP address, you may turn the two DIP switches in the rear of the touch screen to “ON”, and then reset the HMI to enter the built-in SETUP window.

(5) Click **Options** in the **Tools** menu, open the compilation download option, select **Ethernet** for the **Download Device**, and set the **IP Address** and **Port** of the touch screen.

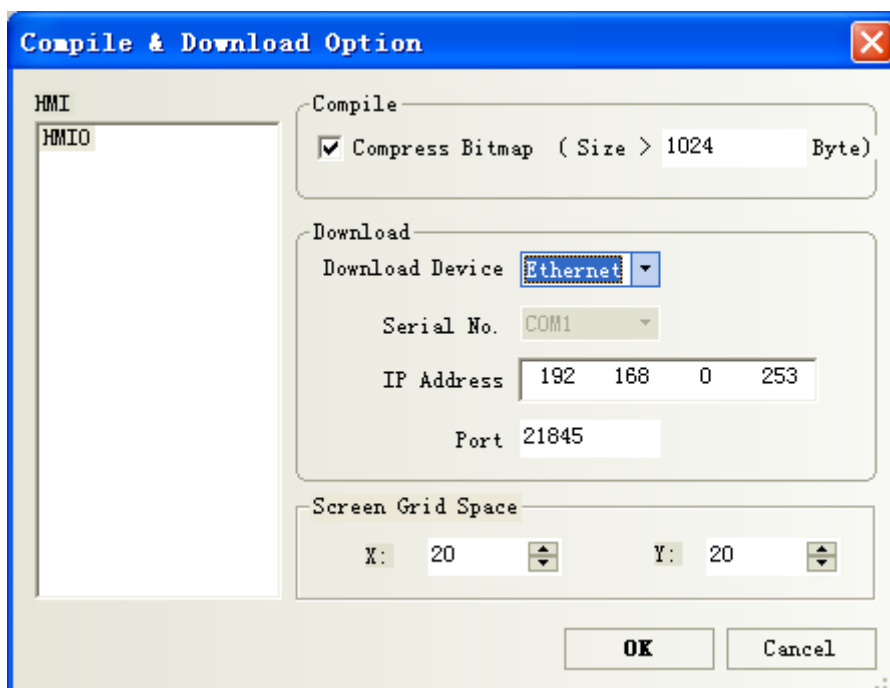



Note: After project download, the IP address of the screen will automatically change to the IP address set in the **HMI Properties** window. If the IP address set in the **HMI Properties** interface is inconsistent with that set in the **Compilation Download Options** window, download by use of the old IP address will fail. In this case, it is necessary to adjust the IP address in **Compilation Download Options** window, or enter the SETUP state to modify the current IP address of the touch screen.

1.2.3 Printer Interface

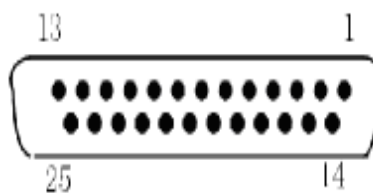

The MT5000 series and the MT4400T/MT4500T series provide a printer interface. The interface setting is the same as a PC interface. The MT4300 series provides a 15-pin print interface.

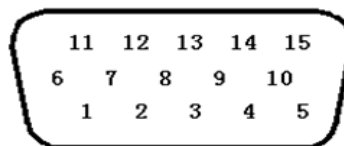

Parallel Print Port (15-pin D-SUB Female Connector)

The user can print window, events, texts and bitmaps online.

(1) Printer setting

In the **Project Structure Window**, double click the HMI icon, and the **HMI Attribute** dialog box appears. Enter the **Printer Settings** window, as shown in the following figure:

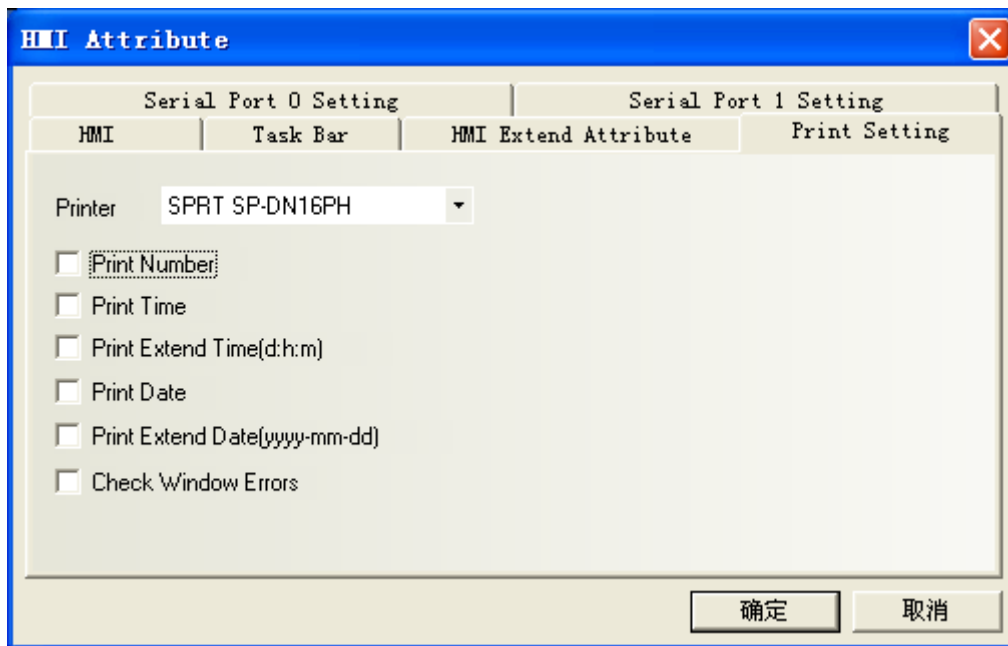

For printing methods, please refer to Chapter 10 which details the print settings and printing methods.

1.2.4 USB Interface

Our MT5000 and MT4000 provide you with a high-speed download channel, that is, the USB interface. The USB interface will greatly increase the download speed, without the need of knowing the IP address of the target touch screen in advance. Therefore, you are recommended to use the USB interface for downloading. For download operations, please refer to Section 3.9.

Chapter 2 Creating a Simple Project

“Ease of use” is one of the most outstanding advantage of our EV5000 configuration software. In this chapter, a step-by-step instruction of creating a simple project containing only one switch control part is given, which makes the user getting started with the basic procedure of project making. More sophisticated projects can be created with similar methods.

2.1 New an empty Project

► Part 1:New an empty project.

1. After installing the EV5000 software, find the corresponding executable program under the directory “**Start → Programs → eview → EV5000**”, and click the *EV5000* icon.



2. The following window appears:

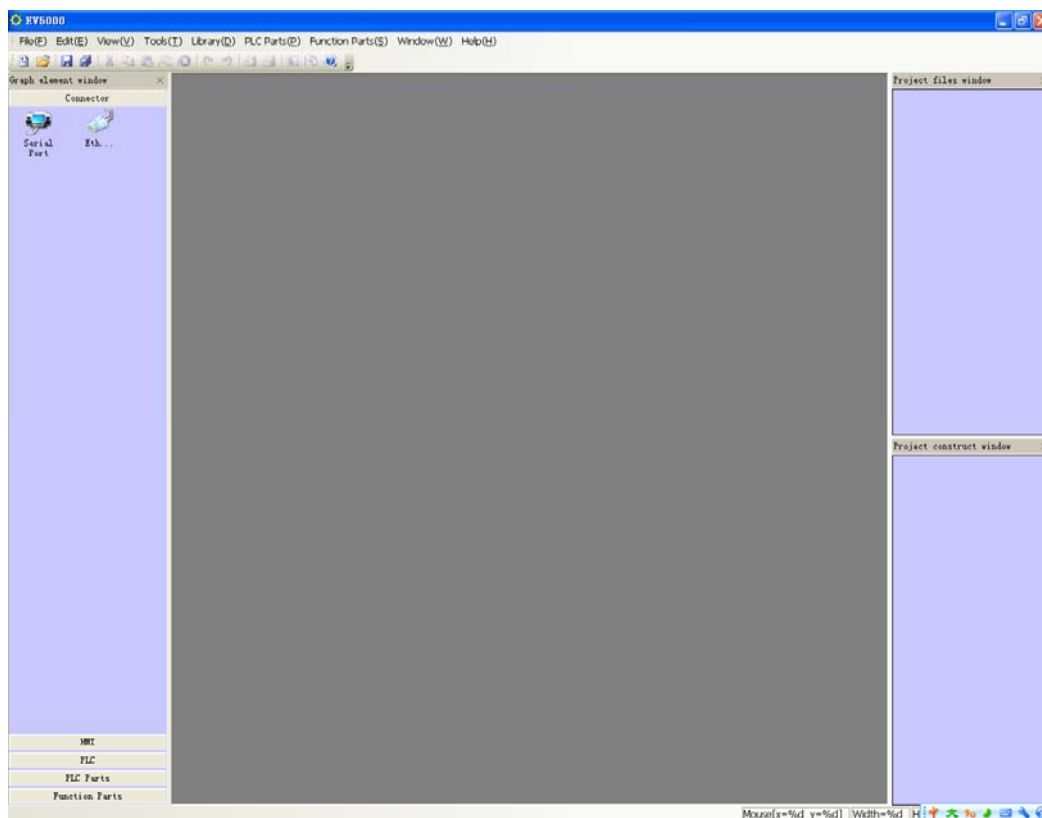

3. Choose **New Project** in the **File** menu, the following dialog box appears. Name the project you want to create. You may also click [>>] to select a path for storing the new project files. In this example, the project name is “test_01”. Click **Create**.

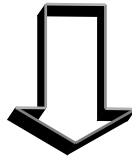
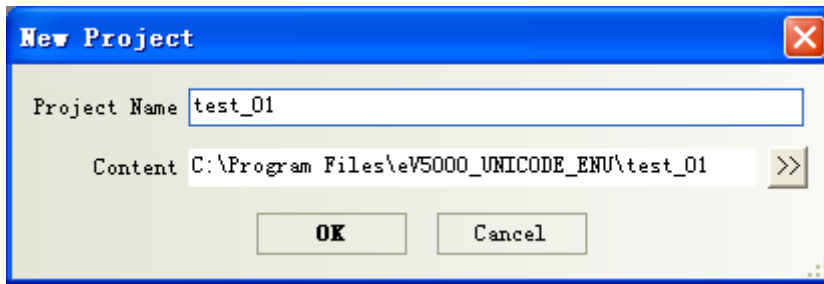

4. Select the proper communication connection mode for the project. The MT5000 touch panel supports serial port and Ethernet connection, while the MT4000 series supports only the serial port now (further revision will support Ethernet also). Click **Connection** in the Component Library window, there are two icons represent serial port and Ethernet mode, respectively. Click the icon of the proper communication mode to select, hold and drag it to the **Project Structure Window**. A wire appears in the Project Structure Window.

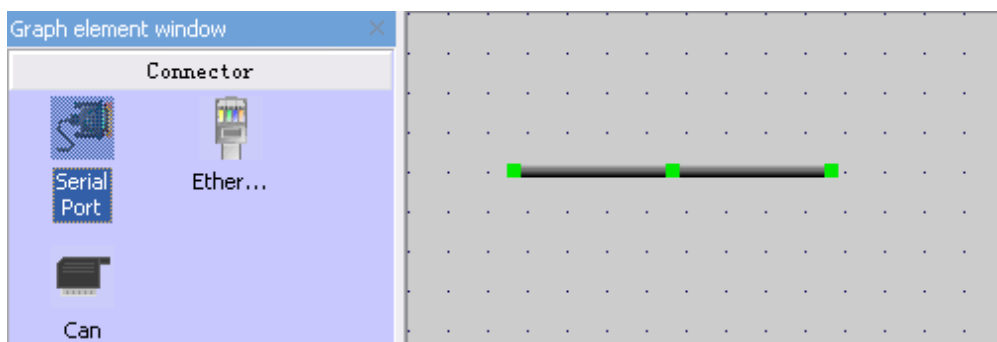

5. In the HMI window, click to select the model of touch panel corresponding to the actual

hardware, hold and drag the icon to the **Project Structure Window**. Release the mouse, and the following dialog box appears:

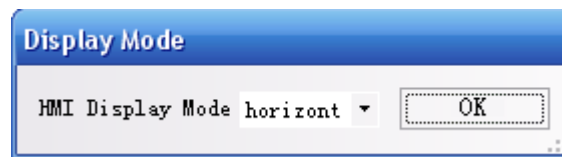

Select **Horizontal** or **Vertical** display mode to view the touch panel in horizontal or vertical direction, click [**OK**].

6. Select the proper PLC to be connected, the PLCs supported by EV5000 are listed in the PLC window, click to select, hold and drag it to the **Project Structure Window**, as shown in the following figure:

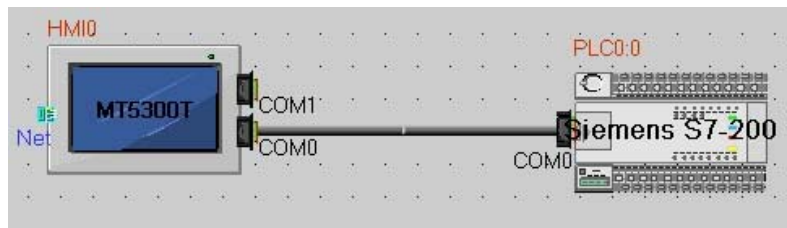

7. In the Project Structure Window, drag to place the HMI and PLC, when the ports (shown as the gray trapezoids) of the HMI or PLC are close to the end of the wire, the wire will automatically attach to the ports, when both ends are attached to one port of a device, the connection is established.
Note: The connection port number should be consistent with the actual physical connection.
8. Click the HMI0 icon, the following dialog box appears:

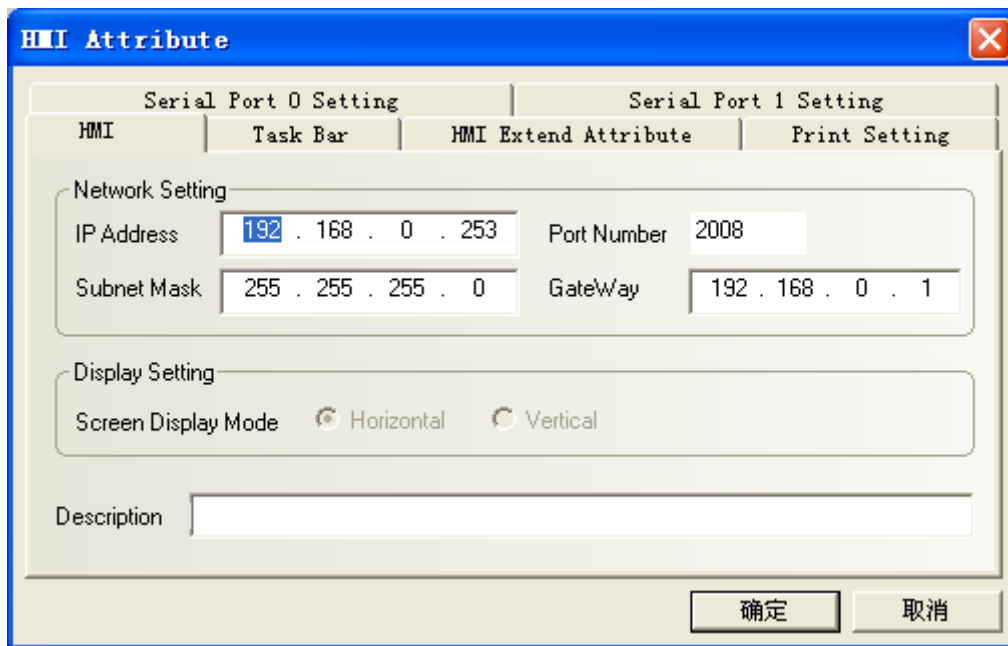

Set the **IP Address** and **Port Number** of the touch panel in this dialog box. If there is only one touch panel in your design and you will not use the function of indirect online simulation or download the project file to the panel via Ethernet, you can simply skip this step. If you use functions such as multi-HMI interconnection via Ethernet or Ethernet download, please allocate a unique IP address to your touch panel according to the actual situations of the LAN (Local Area Network). If there is no conflict over the network, it is recommended not to change the default port number.

9. Double click the PLC icon, set **Station No.** to be the corresponding PLC station number.

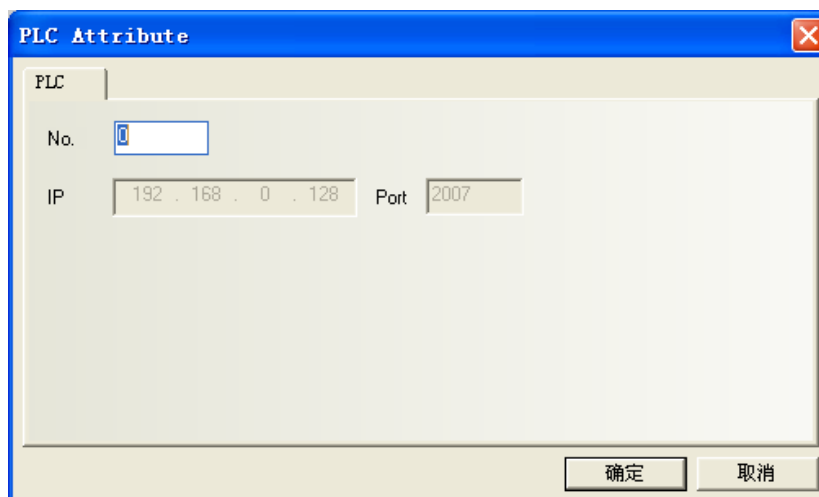

10. Set connection parameters:

Double click the HMI0 icon to show the **HMI Attribute** window. Click the Serial Port1 Setting tab, set the parameters of COM1 settings in this window (If the PLC is connected to COM0, please modify the parameters of COM0, as shown in the following figure:

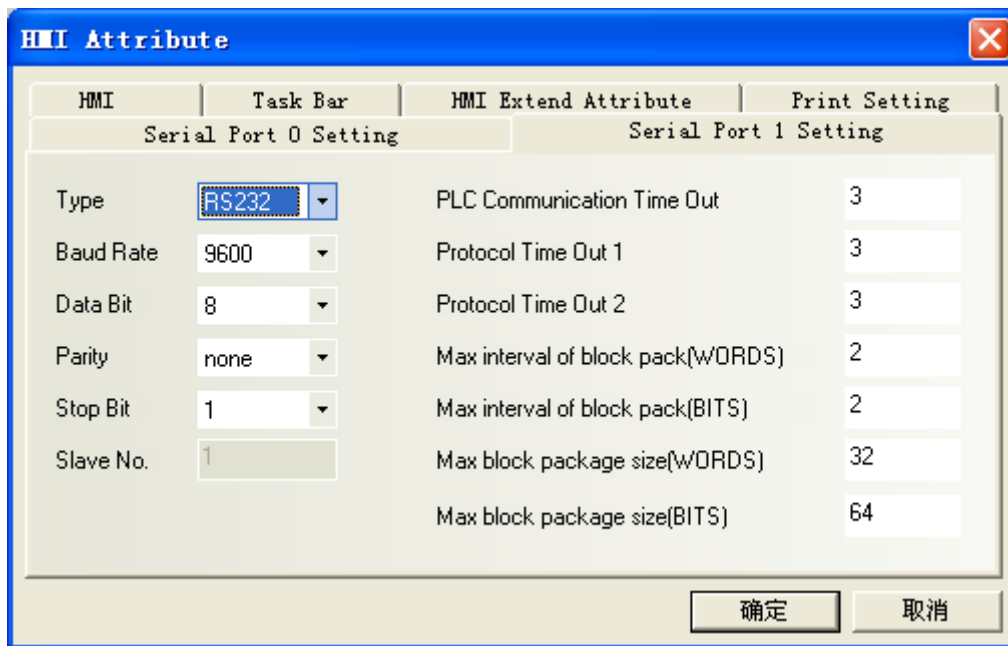

In accordance with your PLC connection, set the **Type** to be RS232, RS485-4W or RS485-2W, and set other properties like **Baud Rate**, **Data Bits**, **Parity** and **Stop Bits**. **If you are not an advanced user, do not change the default settings in the right column.**

11. Select "File"-> **Save** on the menu to save the project.
12. Select **Tools** → **Compile**, or press the **Compile** icon on the toolbar. After the compilation is completed, a message box "Compilation completed" appears in the **Compilation Information Window**, as shown in the following figure:

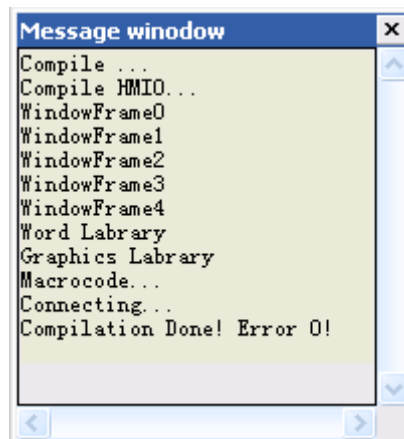

13. Select **Tools** -> **offline Simulation**, or press the **Offline Simulation** icon on the toolbar, as shown in the following figure.

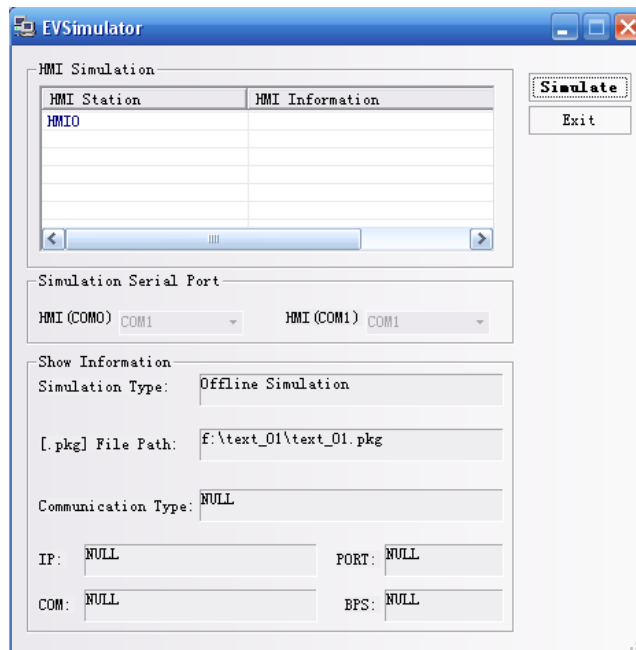
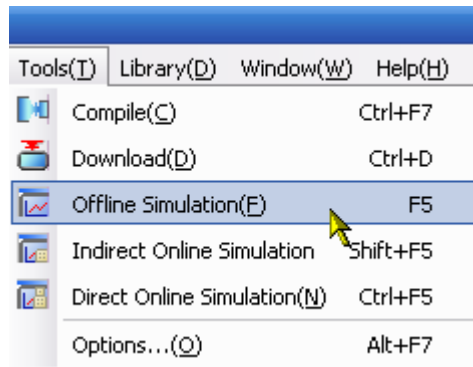

Click **Simulate**, the simulation window of the empty project we have created appears, as shown in the following figure:



The project does not have any components and cannot execute any operations.

To exit the simulation program, right click in the simulation window area and click *close* or directly press the Spacebar .

2.2 Adding a Switch Component

► Part 2: Adding a switch component to the project.

1. In the **Project Structure Window**, select the HMI icon and right click, click **Edit Configuration** in the shortcut menu, as shown in the following figure:

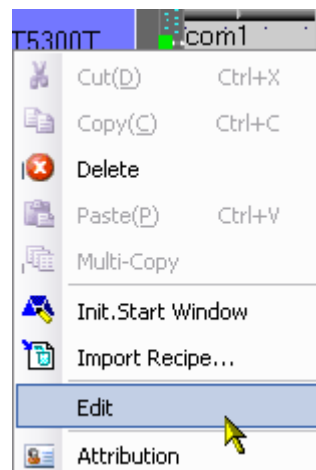

2. The program switches to the window editing mode, as shown in the following figure:

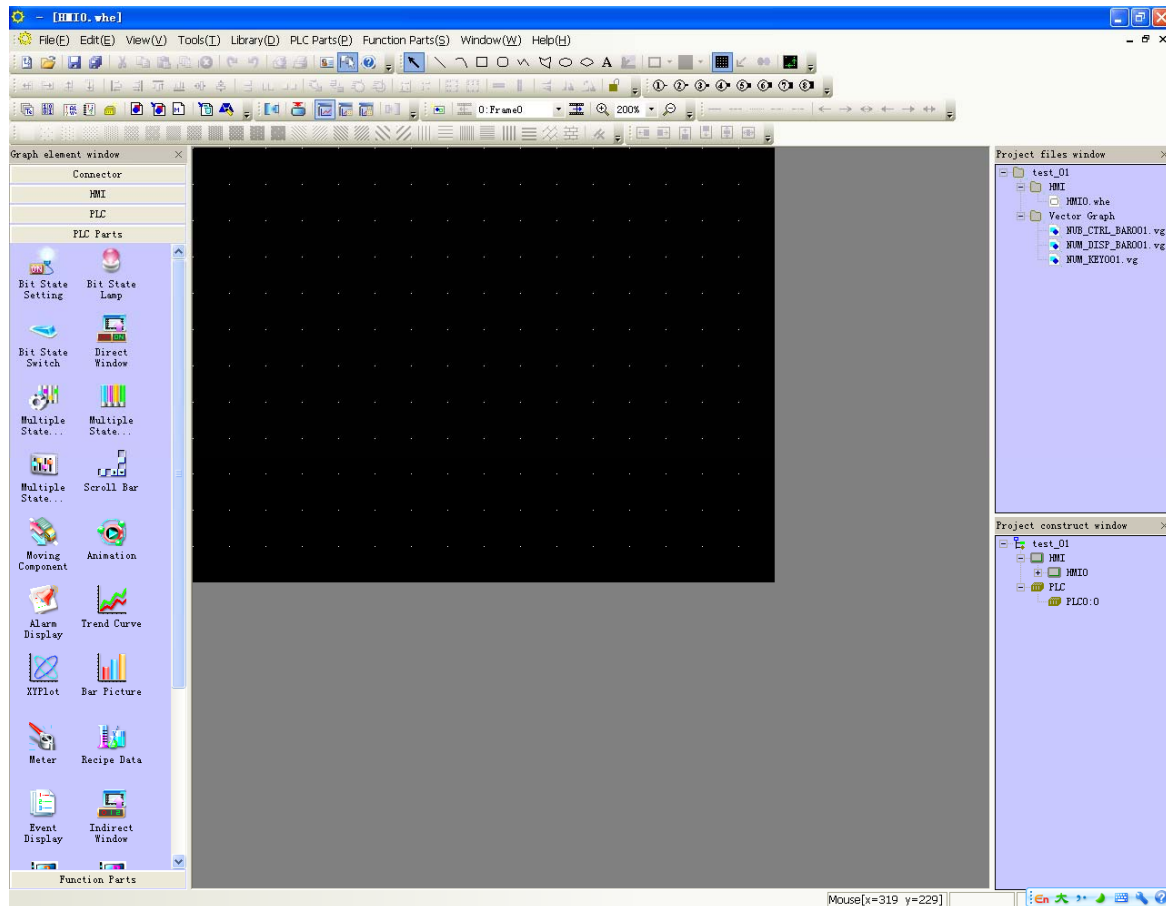

3. In the **PLC Components** frame in the graph element window on the left, click  , hold, drag and drop it to the configuration screen editing area. after dropping, the **General** dialog box in the **Bit Control Components** appears. Set the input/output address of the bit control component, as shown in the following figure:

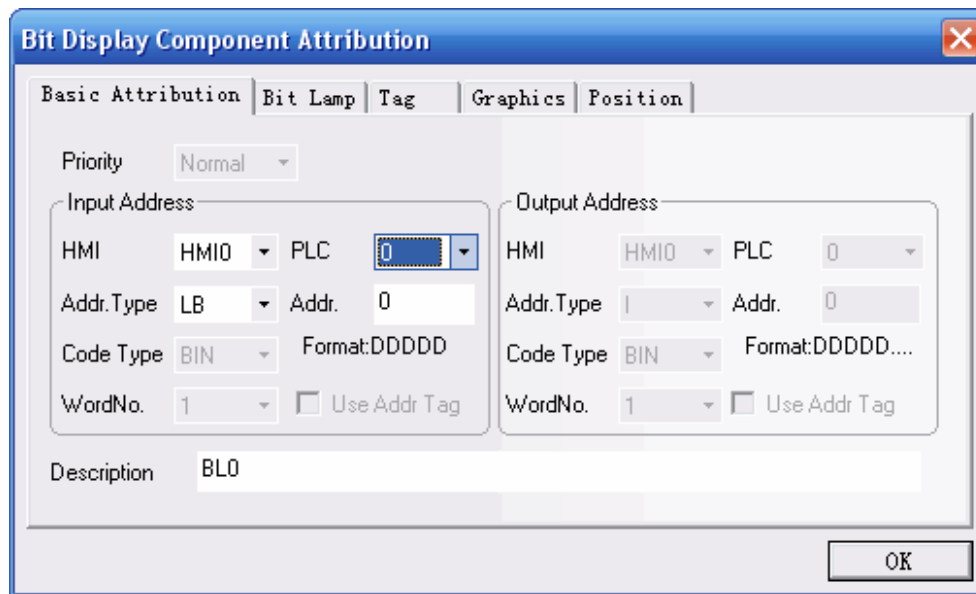

- Switch to the **Switch** tab. Set the **Switch Type**. Select **Toggle Switch** from the list, as shown in the following figure:

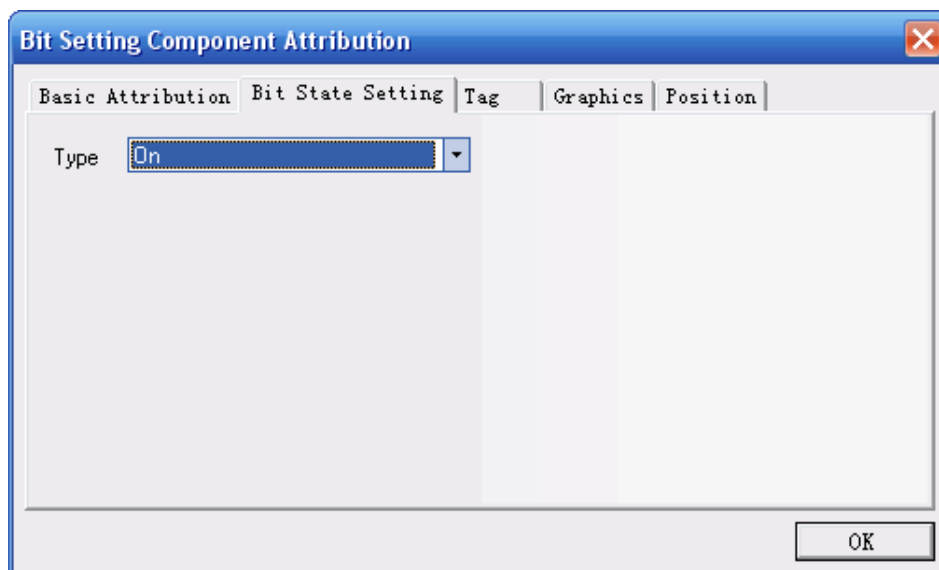

- Switch to the **Tag** tab, select **Use Tag**, enter the texts corresponding to state 0 and 1 in **Content**, and select the label color. (You can modify the alignment mode, font size and color of the labels)

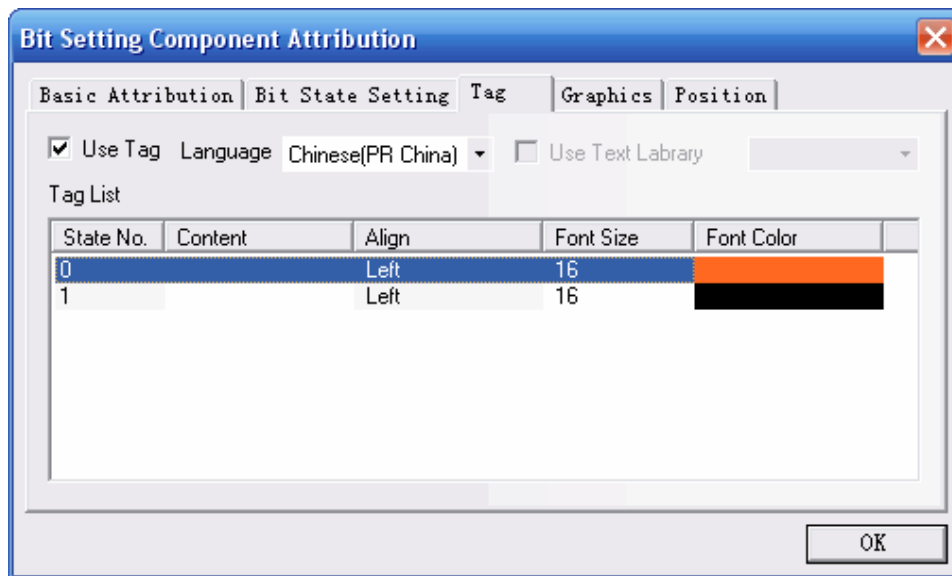

6. Switch to the **Graphics** tab and select the **Use Vector Graphics** check box. Select a wanted shape. Here, the switch shown in the following figure is selected. For the making of the vectogram, refer to Chapter 5.

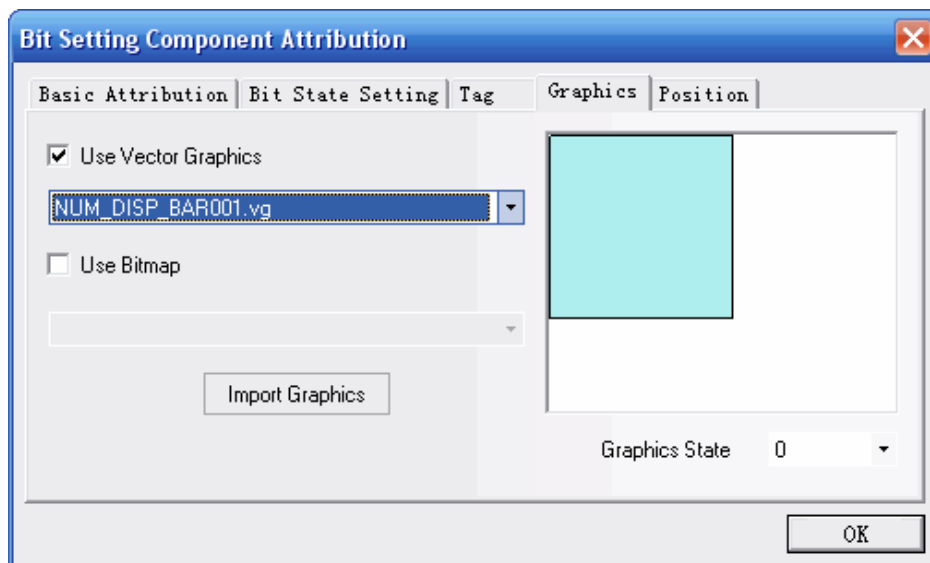

7. Switch to the **Position** tab. There are four inputboxes showing the position and size of the part. “Left” inputbox holds the horizontal position of the upper left corner of the part, “Upper” inputbox holds the vertical position of that corner, the unit of these inputboxes is pixel. The origin of the screen is the upper left corner. So the “Left” value should not exceed the width of the screen and the “upper” value should not exceed the length. For a screen of the resolution of 320*240, the maxim of “left” is 319 and the maxim of “upper” is 239. “Width” is the width of the part shown in the screen and “Length” is the length of it. Also, the maxim of these two inputboxes should not exceed the size of the screen.

- Click **OK** to close the dialog box. The component in place is shown as follows:

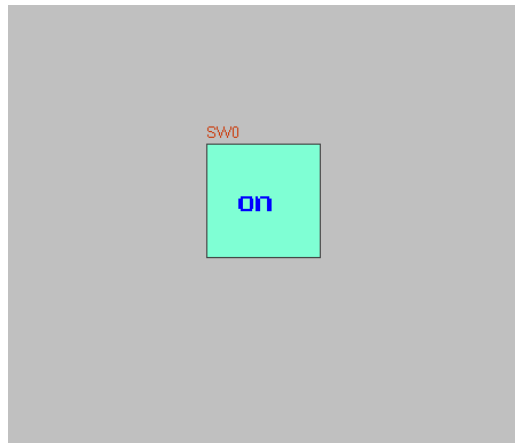

- Select File->**Save** on the menubar, then select the menu **Tools** → **Compile**. If no error occurs during the compilation, the project is completed.
- Select **Tools**→ **Offline Simulation** → **Simulation**. Thus, you can view the switch you have added to the project. You may click it to switch between its ON/OFF state, which acts as the same as a real switch, as shown in the following figure:

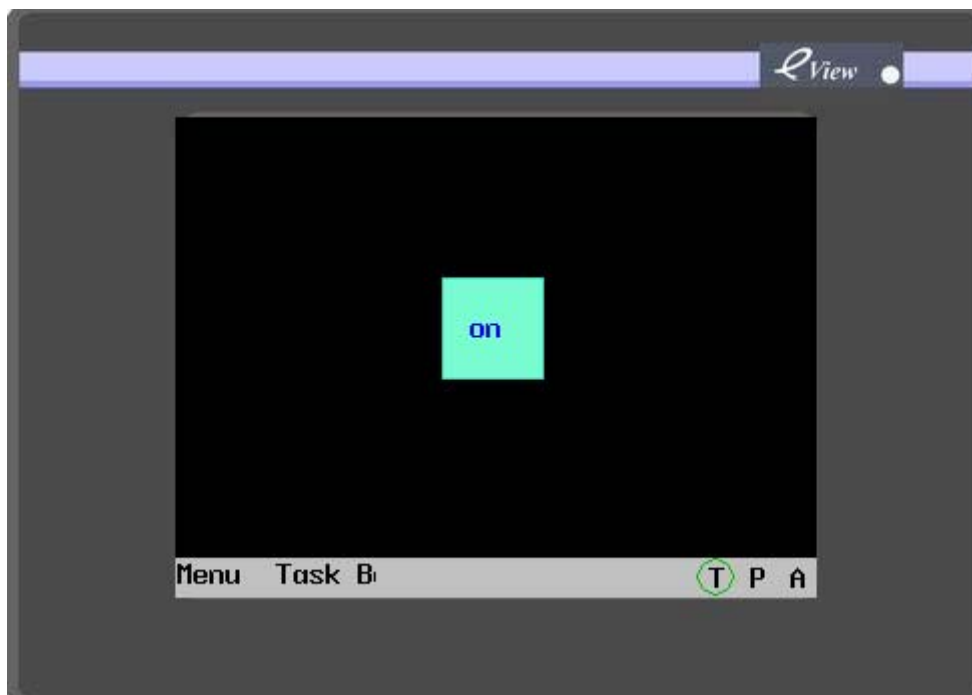

- If you have set the IP address(see page 20), you may use the indirect online simulation.
- Select **Tools** →**Indirect Online Simulation**. You may use your mouse to control the switch on the screen of your PC, and it can be found that the output point Q0 of the PLC can be

controlled. You may use the output of the PLC to change over between the ON/OFF state of the switch. (See chapter 3 for detail of simulation)

13. Select **Tools** → **Download**.
14. After download, reset the touch panel, and you can control the switch by touching the switch shown on the panel screen with your finger.
15. Up to now, the making of the switch is completed. The making of other components is similar. For details, refer to the introduction to related components in Chapter 6. For detailed operations of offline simulation and download, refer to Chapter 3.

Chapter 3 Description of the EV5000 Software

3.1 User Interface of EV5000

Run the EV5000 software, create an empty project by the procedures described in Chapter 2, the EV5000 interface will show the contents as shown in the following figure. The name and function of each item are described as follows:

You may also right click in the **View** or toolbar, to view the toolbars, as shown in the following figure:

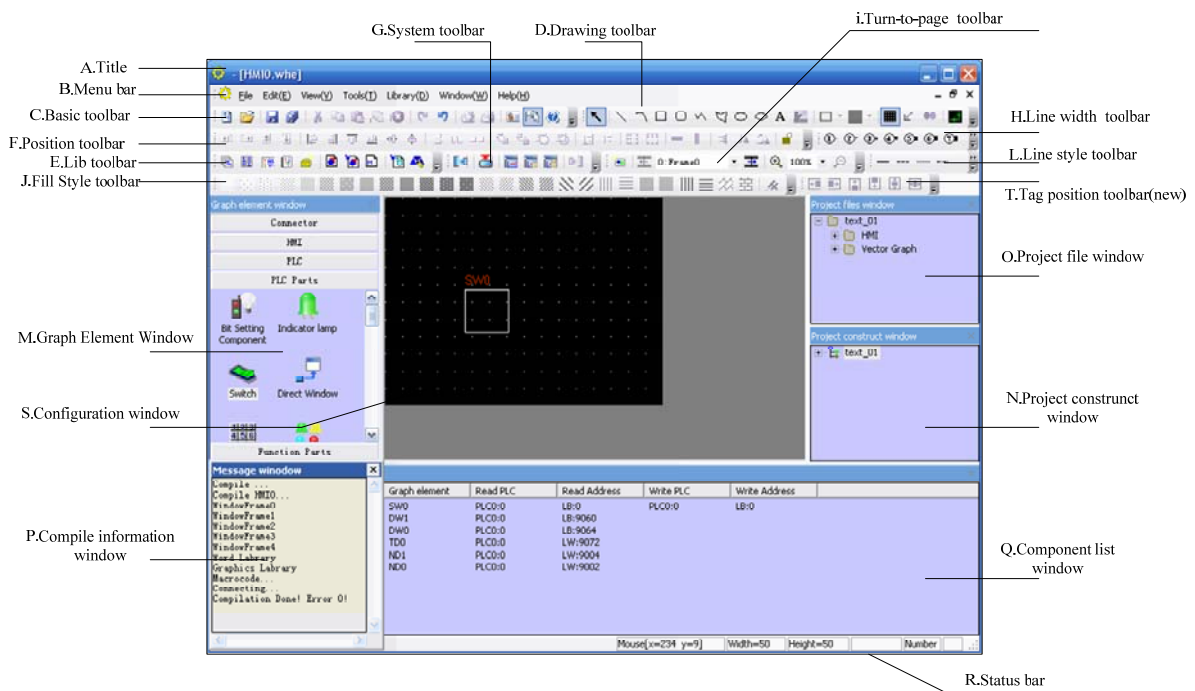

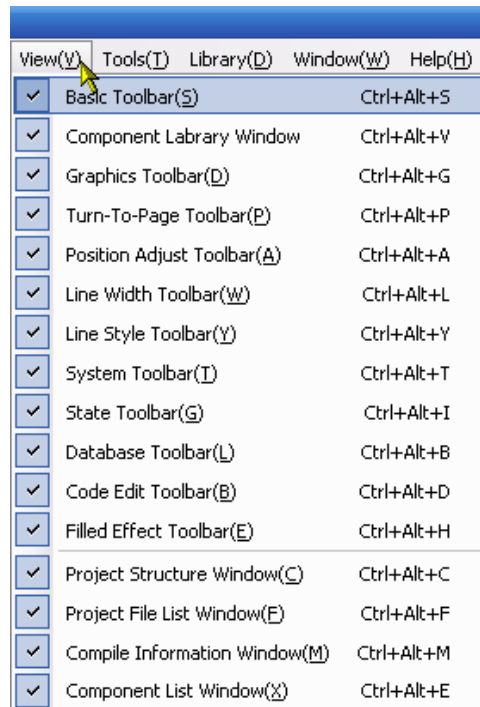

a. Title bar

b. Menu bar

The menu bar provides menus for selecting various groups of commands. If one of these menus is selected, the corresponding dropdown menu appears. Each dropdown menu provides a group of related commands.

c. Basic toolbar

The basic toolbar provides tool icons like **Create Project**, **Open Project**, **Cut**, and **Paste**. For details, refer to the icon descriptions in Section 3.1.4.

d. Drawing toolbar

Each icon stands for a drawing function as it shows. The drawing tools include line tool, rectangle tool, ellipse/circle tool, arc tool, polygon tool and text tool. For detailed information, refer to Section 3.1.4.

e. Fill effect toolbar

This toolbar provides tools used for filling the screen background or areas within a enclosed barriers such as rectangle, ellipse and sector. Each icon represents a filling style. For details, refer to the descriptions in Section 3.1.4.

f. Position adjustment toolbar

It is used for adjusting the position of components, such as, Align Top, Align Bottom, Justify, Align right, Equal Size, Cascade, Group, flip, and so on.

For details, refer to the descriptions in Section 3.1.4.

g. System toolbar

It is used for compiling, downloading and simulating a project.

For details, refer to the descriptions in Section 3.1.4.

h. Line width toolbar

It is used for adjusting the line width.

For details, refer to the descriptions in Section 3.1.4.

i. Turn-to-page toolbar

It is used for scrolling forward and backward within the pages of a project.

For details, refer to the descriptions in Section 3.1.4.

j. Database toolbar

It includes text library tool, alarm messages tool, address labels tool, PLC control tool and event messages tool.

For details, refer to the descriptions in Section 3.1.4.

k. Code compilation toolbar

It is used for controlling the compilation of codes.

For details, refer to the descriptions in Section 3.1.4.

l. Line style toolbar

This toolbar is used for selecting the line style: with or without an arrow, be a dotted line or solid line. The style of lines, arcs and the outline of rectangles are also set by this toolbar

For details, refer to the descriptions in Section 3.1.4.

m. Graph element window

The Graph element window has five optional columns:

Connector: Used to select the type of communication link;

HMI: Used to select the HMI type;

PLC: Used to select the PLC type;

PLC parts: Used to select various configuration parts related to PLC registers;

Function parts: Used to select various functional parts.

n. Project construct window

The **Project construct window** shows the tree relationship between project windows and parts of the PLC and HMI in the entire project with a tree diagram.

For details, refer to the descriptions in Section 3.4.

o. Project files window

The **Project files window** indicates the relationship between the touch panel and bitmap files of the project in tree structure.

For details, refer to the descriptions in Section 3.3.

p. Compile information window

For details, refer to the descriptions in Section 3.5.

q. Component list window

For details, refer to the descriptions in Section 3.6.

r. Status bar

The [状态条] (**Status bar**) shows the current mouse position, width/height of the target object, edit status, and so on.

s. Configuration window

The user can draw the configuration in this window.



Note: To change the color of the fonts and the fill color of the window and rectangles, directly

click the line color button .

3.1.1 The File Menu

- **New Project**

Select **New Project** in the [File] menu or click the icon  to create a new project.

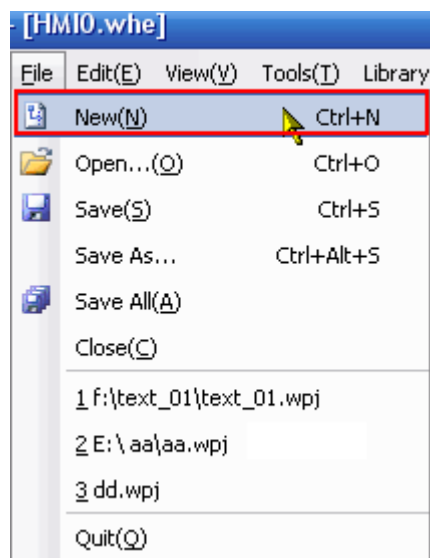

Enter a project name, Press [OK], a new project will be created.

- **Open Project**

Select **Open Project** in the **File** menu, or click the  icon to open an existing project.

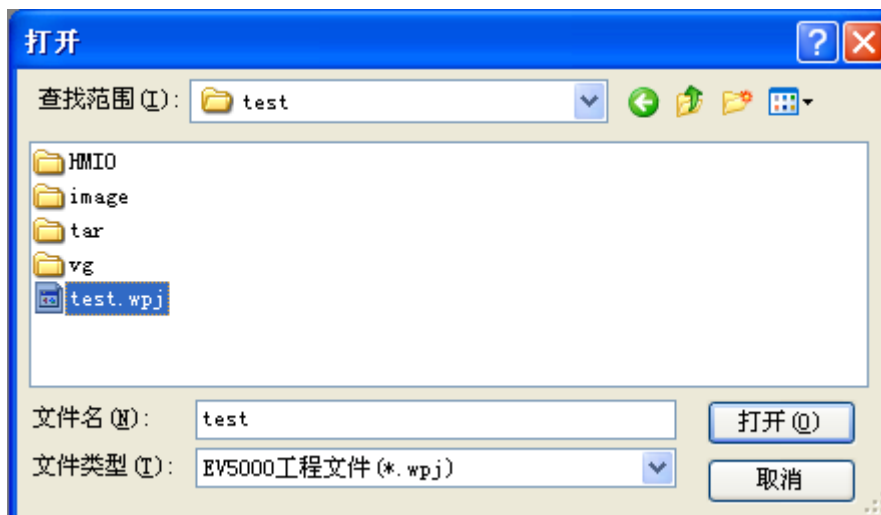
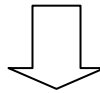
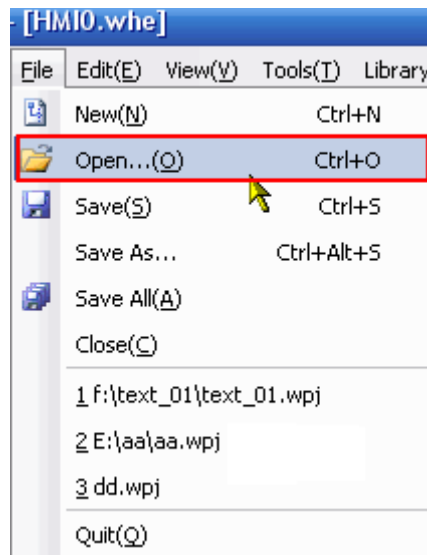

Select a project file(.wpj file) to be opened, click **Open** or double click the project file to open it.

- **Close Project**

Select **Close Project** in the **File** menu, the current project will be closed. If it has not been saved before, the program will ask the user to save it.

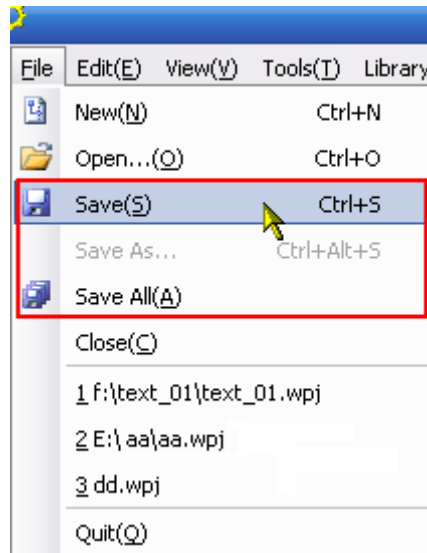

After clicking **Close Project**

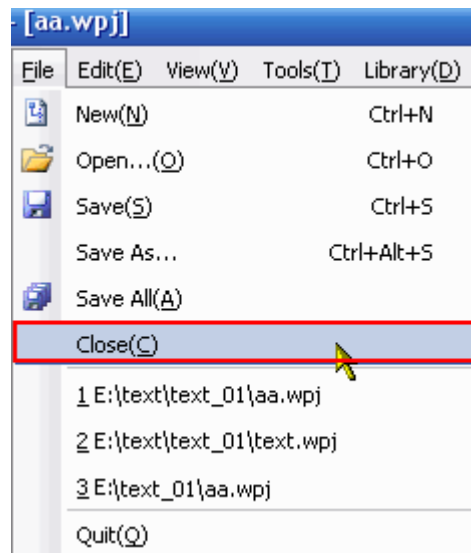

all the current windows will be closed, as shown below:

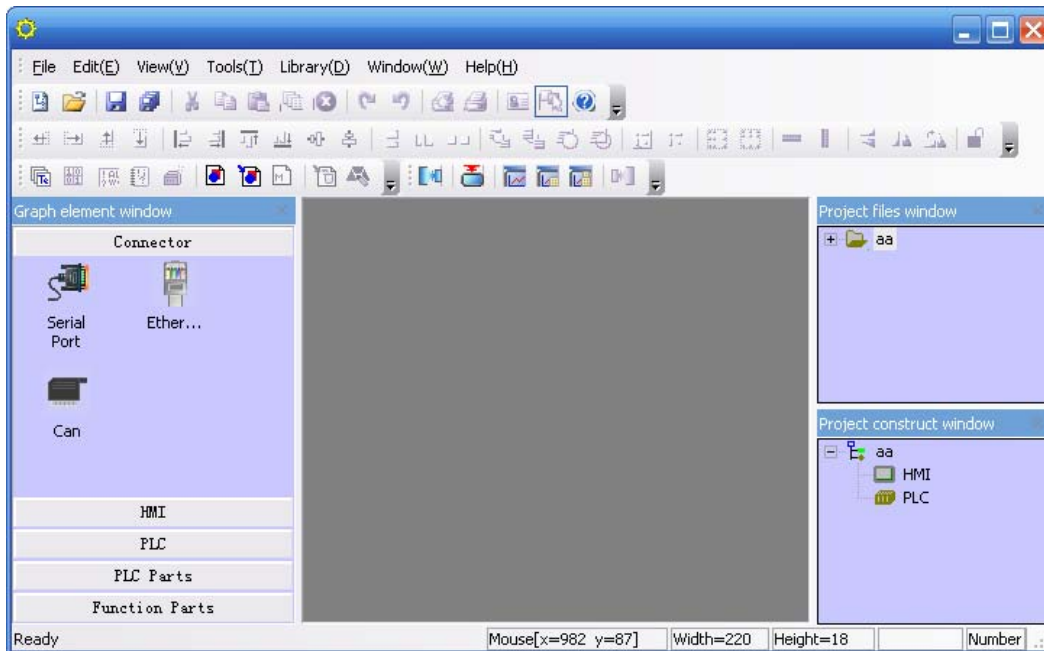

- **Files recently opened:** the program automatically remember the most recently opened 3 files' name and path, the user can quickly open them in the "File" Menu.

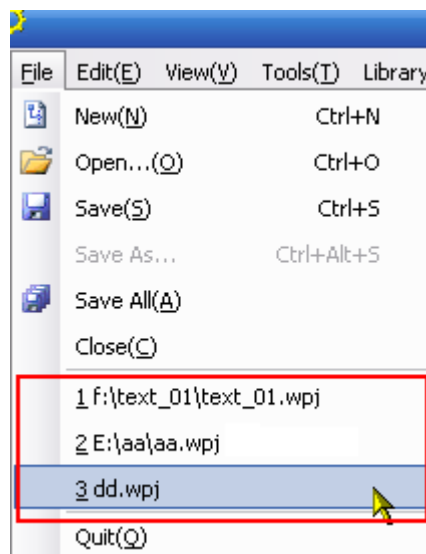

- **Exit**

Select **Exit** in the **File** menu to exit the EV5000 configuration software.

3.1.2 Edit

- **Undo**

Use this function to undo the latest operation, the screen will return to the state before this operation. click the icon  or select **Undo** in the **Edit** menu will activate this function.

- **Redo**

Use this function to redo the operation which has just been undone by the Undo operation. Click



or select **Redo** in the **Edit** menu.

The **Undo/ Redo** support the following operations:

1. Drag a component from a component library window
2. Draw a static component
3. Move an object
4. Adjust the size of an object
5. All operations on the position toolbar
6. Line width, line style, and arrows
7. Fill style of an object
8. Frame color of an object
9. Fill color of an object
10. set to Top layer, set to bottom layer
11. Group and ungroup of multiple parts
12. Cut, copy, paste and delete of objects
13. Multiple copy

To add any component to the screen or to make any change to the screen, the user can use the **Undo/Redo** function. As shown in the following figure, add a switch component to the screen:

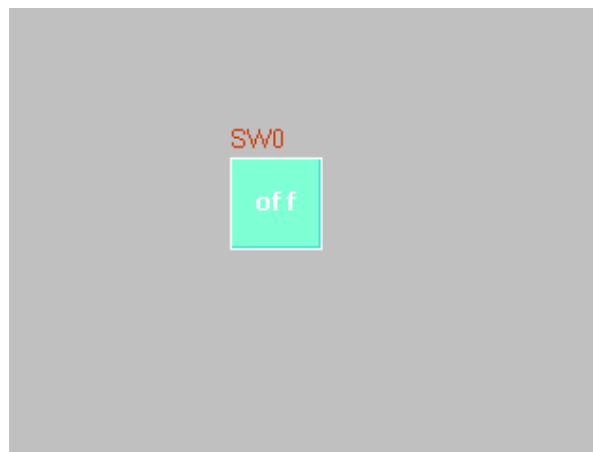

Press **Undo**:



The switch part disappears, leaving a blank screen.

Then click **Redo**:



The switch re-appears



The software supports the “**Undo/Redo**” operation of the latest ONE operation.

- **Cut, copy, paste and delete**

Select one or more components, you can conduct such operations as **Cut**, **Copy** and **Paste**. Their corresponding icons are . Their demonstration is omitted here.

- **Nuage**

Select a part, the position of the object can be adjusted by using the Nuage tools, or you can use the **Nuage** icon to move the component. Every time when you click **Tune**, the component will move by the distance of one pixel. Its corresponding icons are , respectively indicating **Move Left by One Pixel**, **Move Right by One Pixel**, **Move Up by One Pixel**, and **Move Down by One Pixel**, which correspond to the contents of the **Nuage** in the **Edit** menu one by one. A simple method to use the “Nuage” function is to use the direction keys of the keypad, to move the component conveniently.

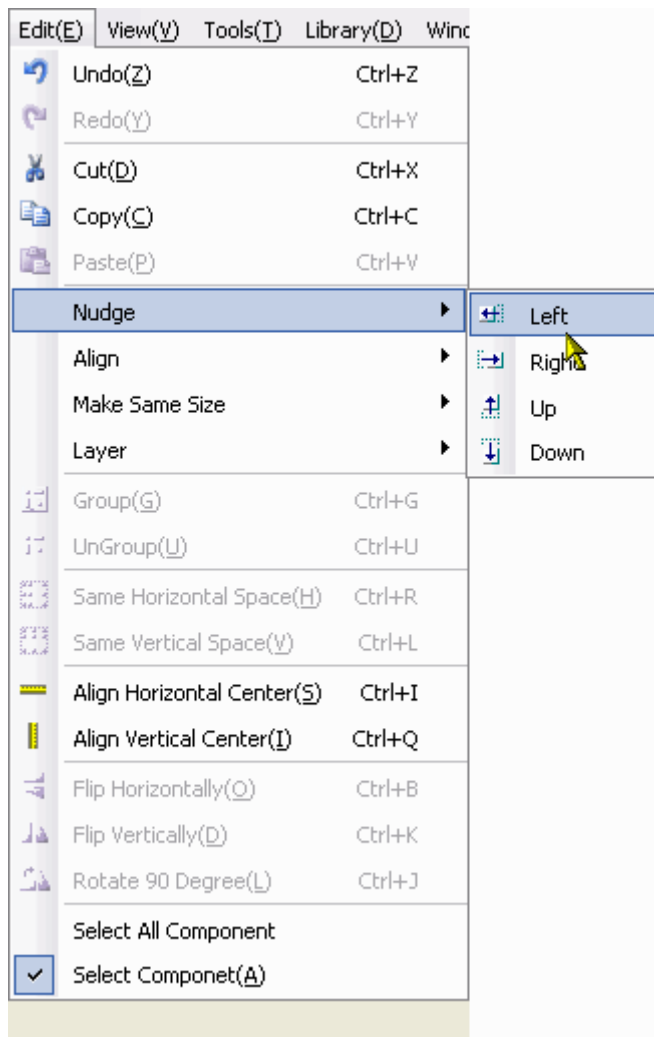

- **Align**

It is used to implement the Justify the alignment of multiple parts. With the Alignment tools, users can Align right, Align Top, Align Bottom, Vertical Center and Horizontal Center. Their corresponding icons are . Here, we only conduct the “Left” operation. The effect after the “Left” operation is as follows:

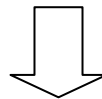
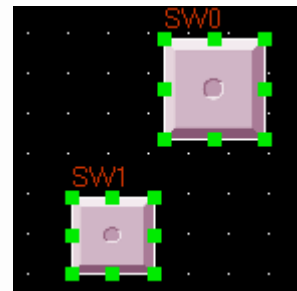
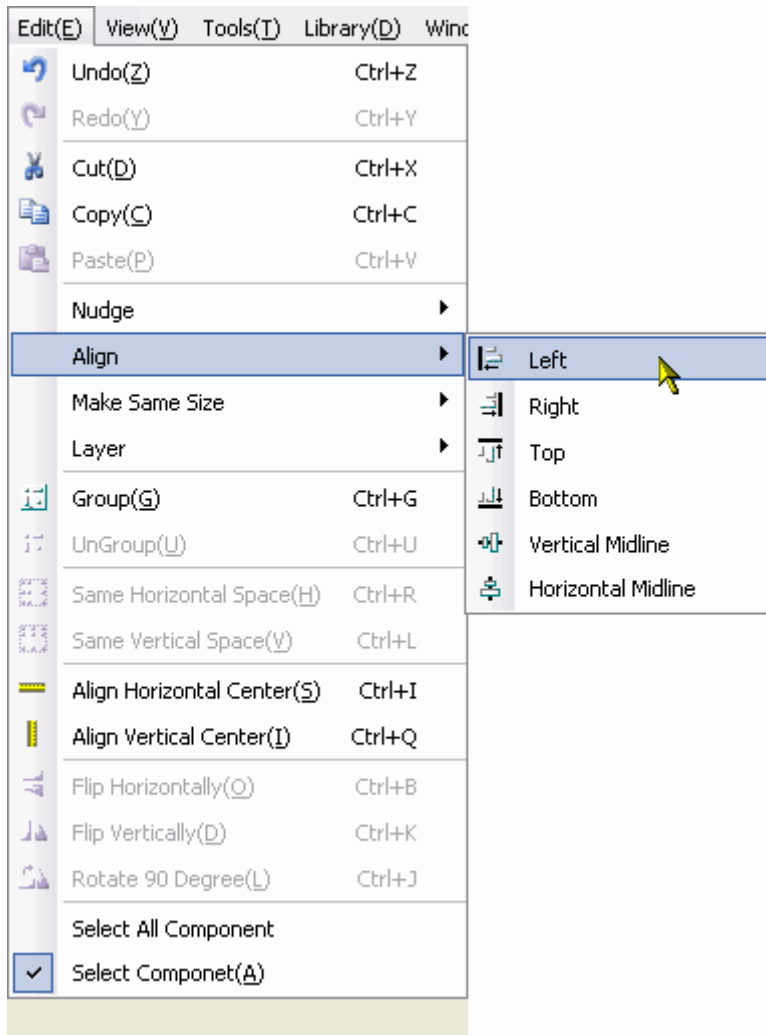

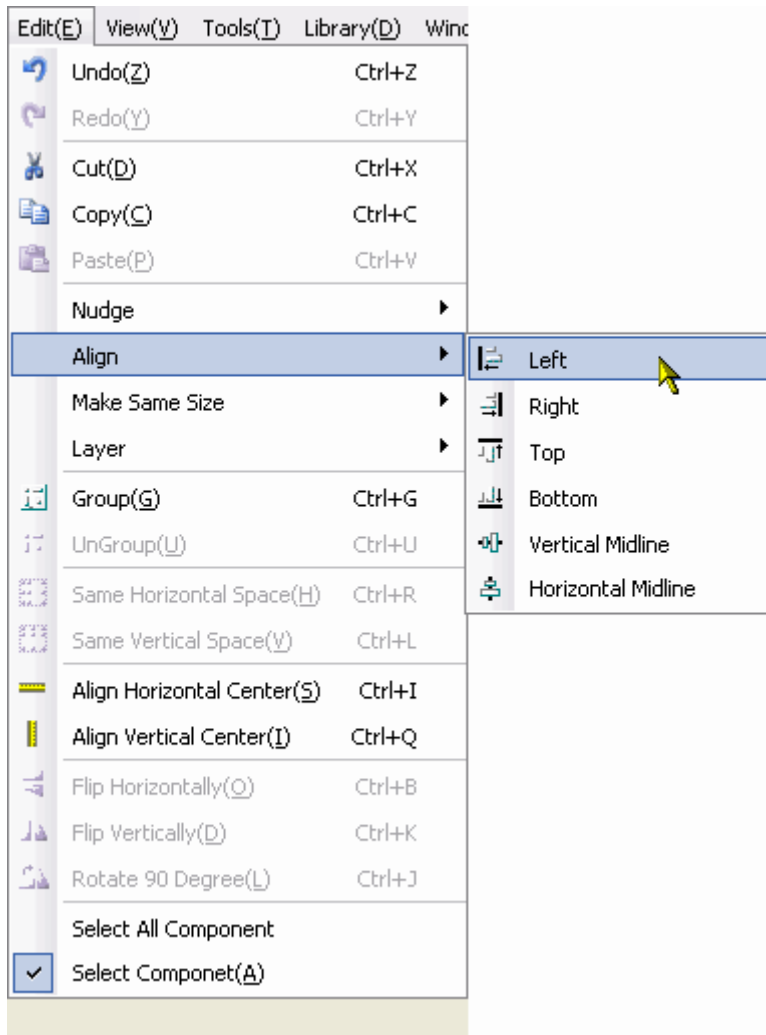

After the “Left” operation, the two parts line up to the left side.

- **Size**

To make multiple components have the equal width, equal height or equal size, press the corresponding icons for adjusting component size, or select the related menu items. The related icons are , which respectively indicate equal width, equal height, and equal size. The default component for size reference is the component in the left. Adjust other components to be of the same width, height or size as this one. To designate a component as a reference component, press and hold the [**Shift**] key to select the reference component, and then select other components.

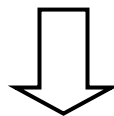
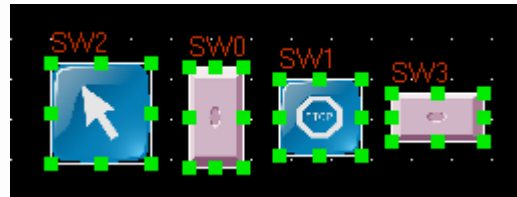
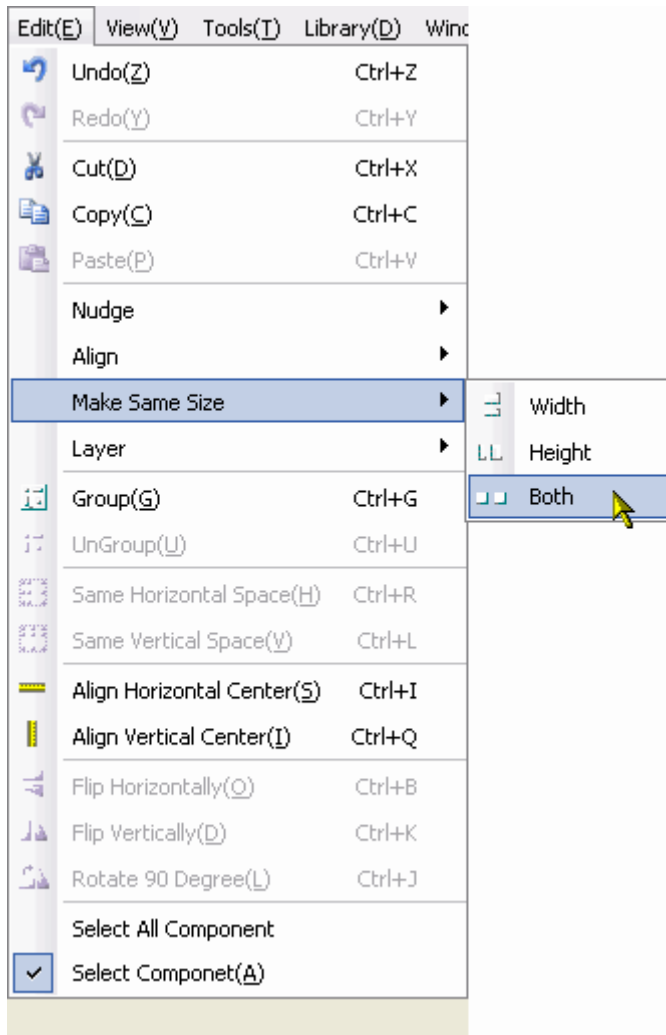

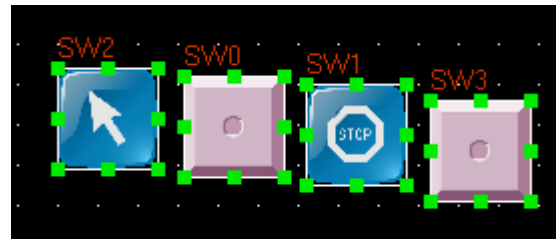
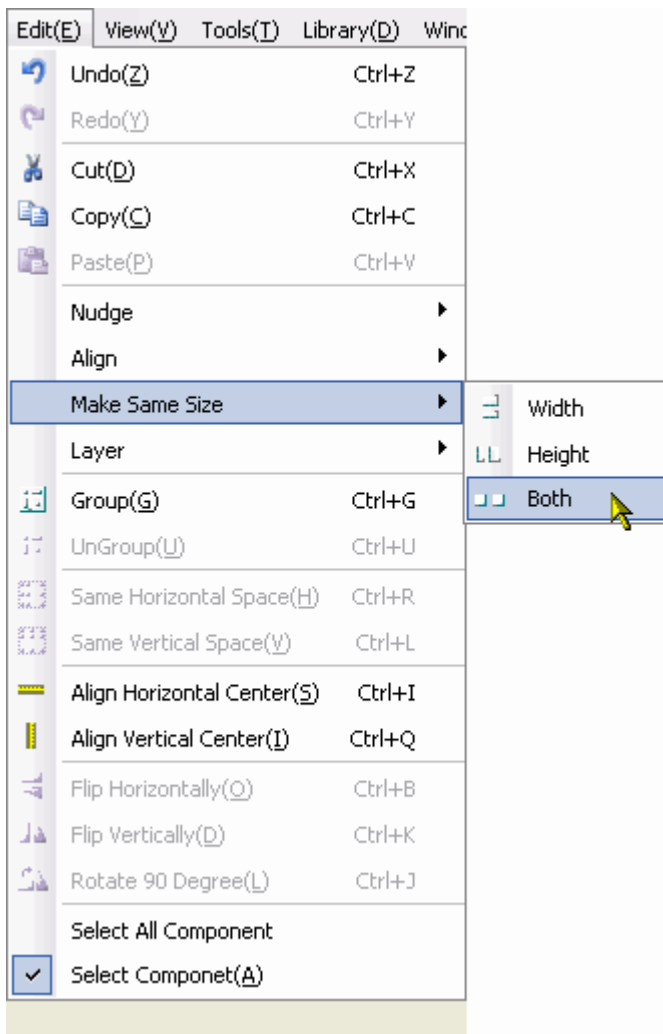



- **Layer**

If multiple components are overlapped, you can use the icons  (Top, Bottom) or select **Set Top Layer** and **Set Bottom Layer** in the **Layer** submenu in the **Edit** menu to change the layer sequence of the components.

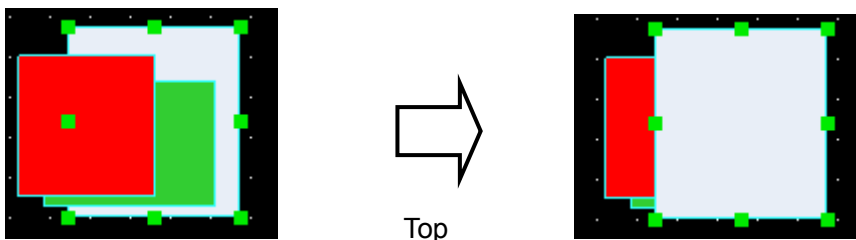
First select a component, then click the related icon to set the component to the expected layer. The components on the top layer are always displayed above the components on the layers below.



- **Group/Ungroup**

This function can be used to group multiple selected components or shapes, so that they can be used as a single component. To group multiple components, select these components, and then select **Group** in the **Edit** menu or click the icon . To ungroup, select the grouped entity, and

then select **Ungroup** in the **Edit** menu or click the icon .

- **Equal horizontal space**

This function can be used to implement the equal horizontal space between multiple selected components and shapes. First, select a shape or component to be operated, and then select **Equal Horizontal Space** in the **Edit** menu or click the icon . The effect is as follows:



- **Equal vertical space**

This function can be used to implement the equal vertical space between multiple selected components and shapes. First, select a shape or component to be operated, and then select **Equal Vertical Space** in the **Edit** menu or click the icon .

- **Horizontal center**

This function is used to place multiple selected components or shapes in the horizontal center position of the window. First, select a shape or component to be operated, and then select **Horizontal Center** in the **Edit** menu or click the icon , as shown in the following figure:

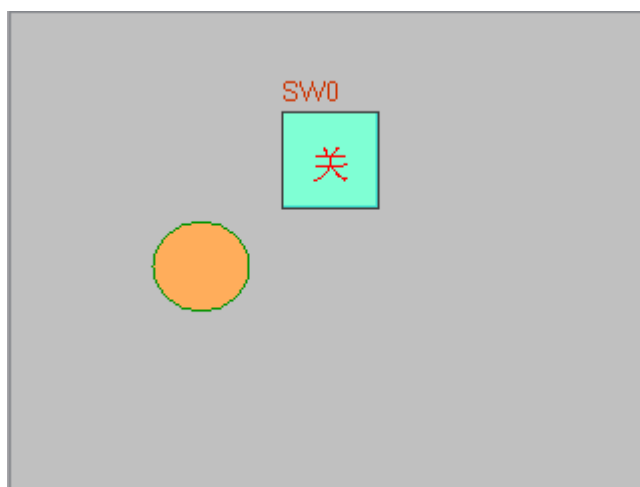

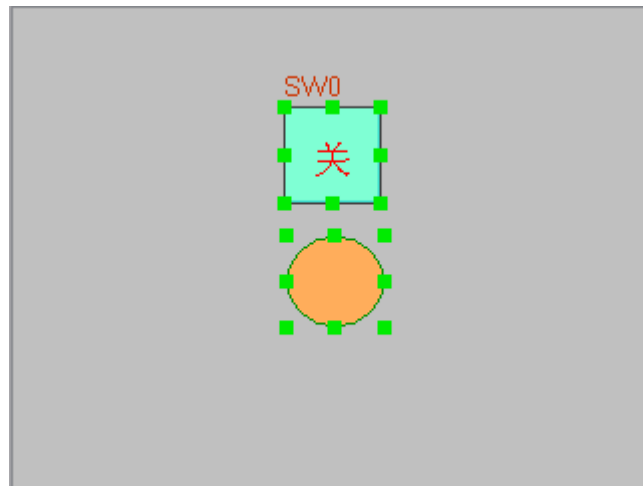



- **Vertical center**

This function is used to place multiple selected components or shapes in the vertical center position of the window. First, select a shape or component to be operated, and then select **Vertical Center** in the **Edit** menu or click the icon . The figure is omitted.

- **Flip and Rotate**

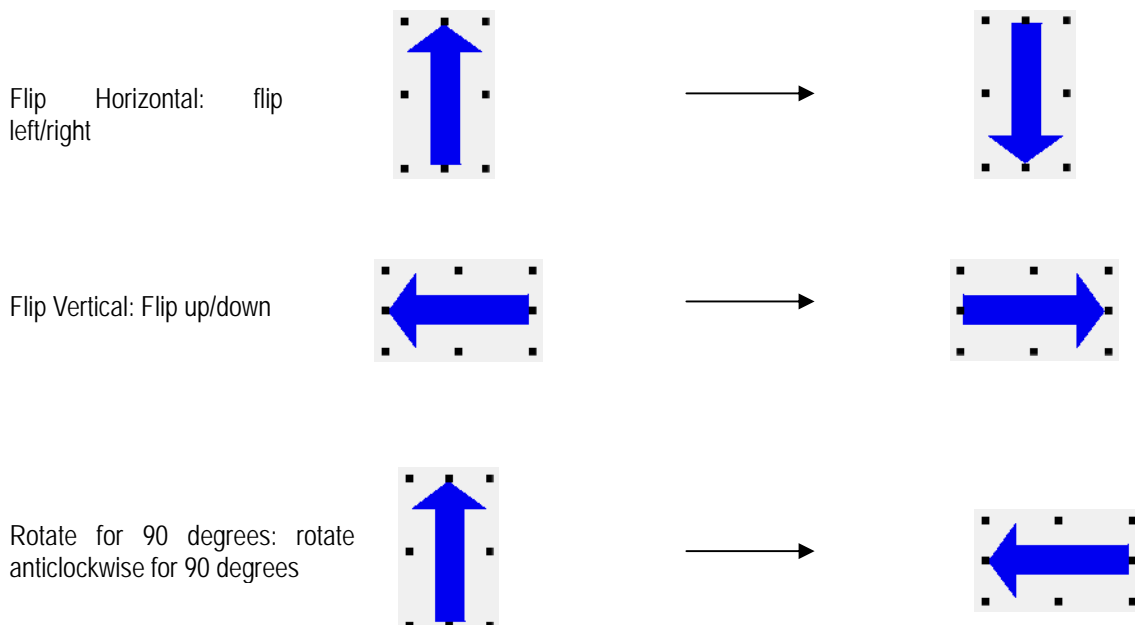
Only shapes drawn by drawing tools can be flipped, such as straight lines, circles, and polygons. Other components cannot be flipped. First, select a shape to be flipped, and then select **Flip**



Horizontally, Flip Vertically and Rotate 90° in the **Edit** menu or select the icon  to flip the component.

3.1.3 View

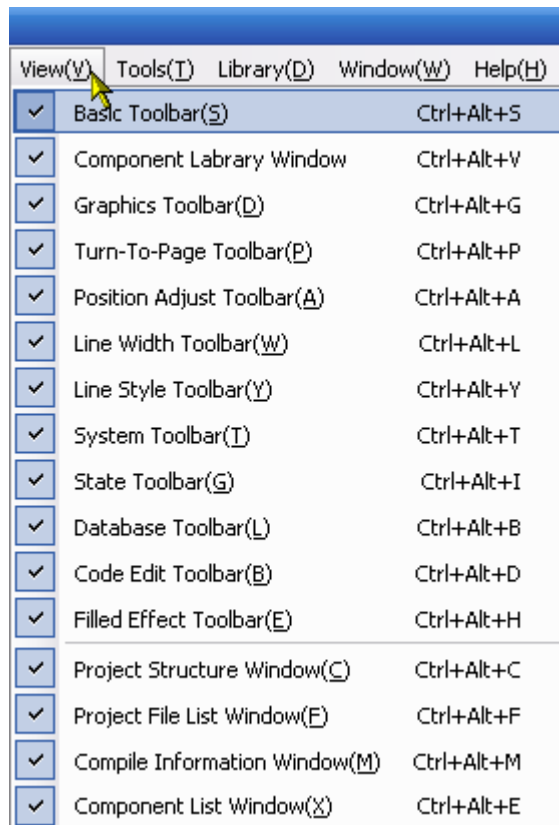

The **View** menu provides control over the display of various toolbars and windows. To make the expected toolbars and windows visible in the user interface, check the corresponding item on the **View** menu.

- Standard toolbar: As shown in the figure, the contents of the standard toolbar correspond to the contents in the menu in turn:

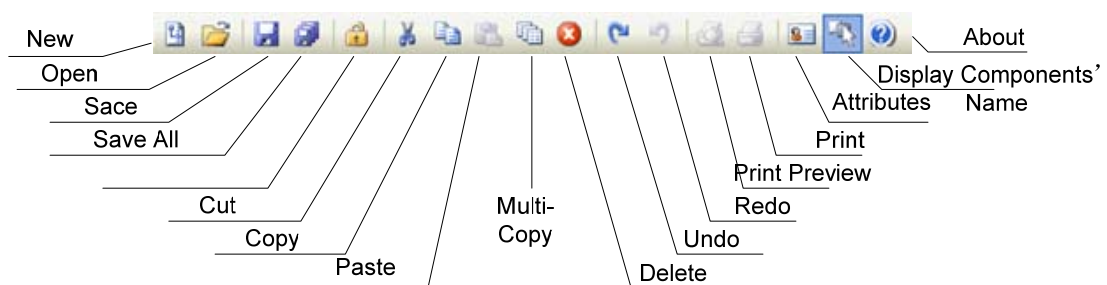

New Project: Create a project;

Open Project: Open an existing project;

Save: Save the current project;

Save All Active Files: Save all the currently opened active files;

Cut: Cut;

Copy: Copy;

Paste: Paste;

Multiple Paste: Multiple copy;

Delete: Delete a component;

Cancel: Cancel the latest operation;

Restore: Restore the latest cancelled operation;

Print Preview: Print preview;

Print: Print;

Properties: Display the properties of an object;

Show Component Name: Show the name of a component;

About: EV5000 version description.

- **Multi-Copy**

This function is used to make multiple copies of selected parts, which can save more time. Select components, and click the  icon to copy multiple components, as shown in the following figure:

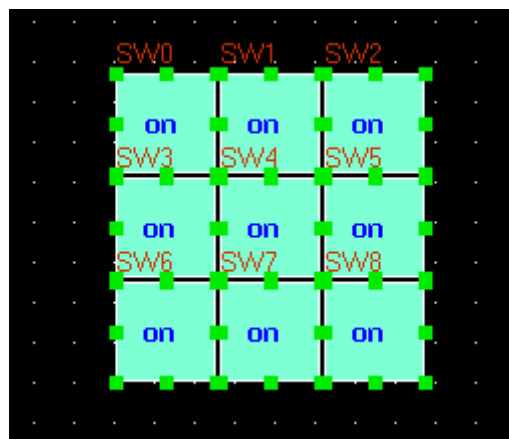
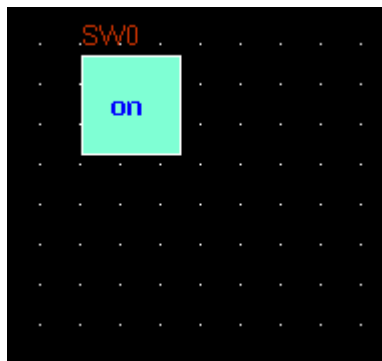

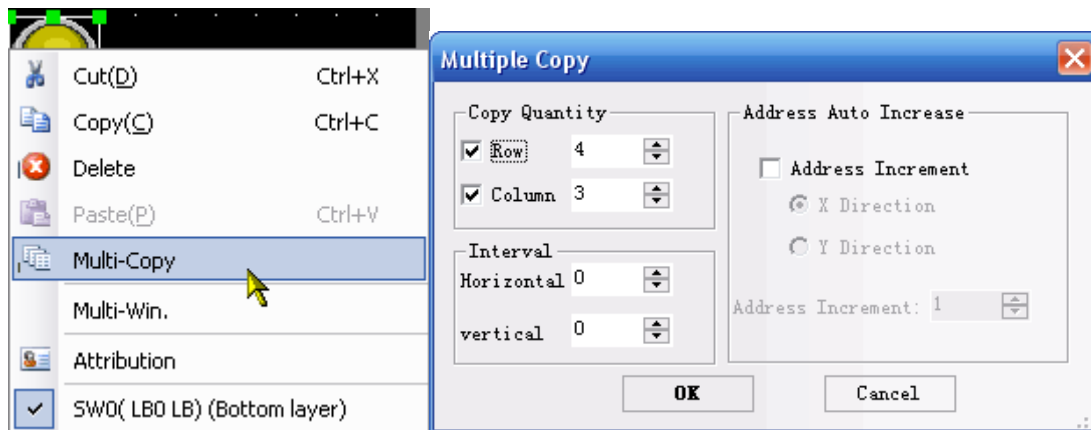

A configuration window appears for entering the copy quantity, interval of the copies and some other options.

Attribution: To change the attributions of a component, select the component, double click it or click the icon , the Properties dialog box of the component appears. The user can make editing in this dialog box.

- **Database Toolbar:** As shown in the following figure, the contents of the items in the menu correspond to each other, which are as follows in turn:

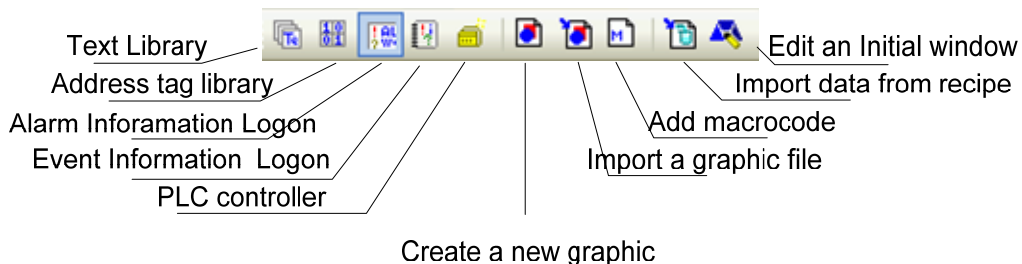

Text Library: Stores text tags;

Address tags: Stores address tags

Alarm Information Logon: Enter alarm messages;

Event Information Logon: Enter event messages;

PLC Control: Adds PLC control components;

(New Graphics): Creates a vectogram or a bitmap;

(Import Graph Library): Imports a vectogram or a bitmap;

(Add Macrocode): Adds a macrocode;

(Import Recipe Data File): Import a Recipe data file;

(Edit Initial Window): Click this button to switch the window to the startup screen edit window, where you can edit the initial display window upon the power-on startup of the HMI panel, as shown in the following figure:



The default initial window is the logo of *Stepservo Co., Ltd.*

- **Line style toolbar:** As shown in the following figure, the contents of the items in the menu correspond to each other in turn:

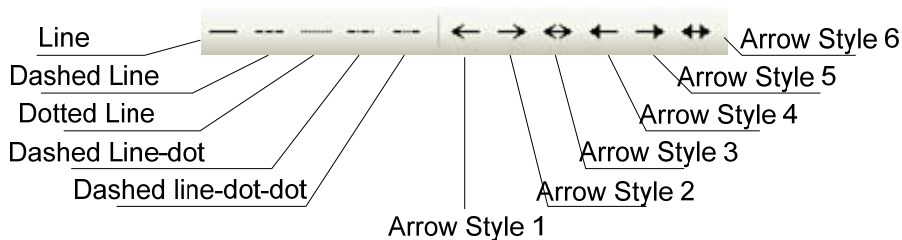

- **Position adjustment toolbar**

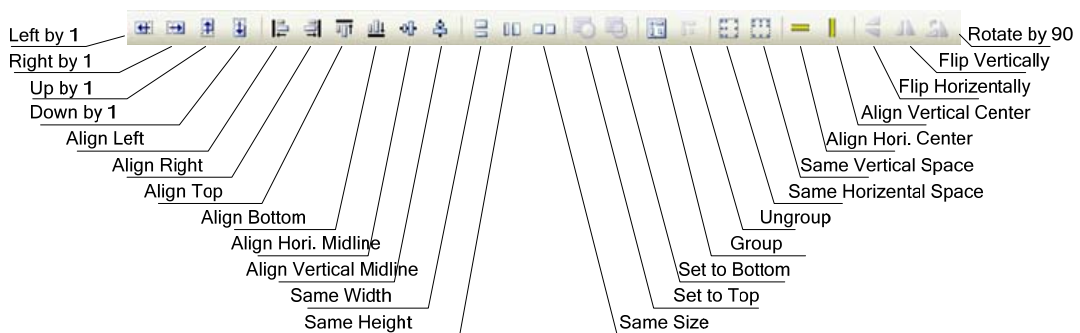

(Move Left by One Pixel): Sets a component to move left by one pixel;

(Move Right by One Pixel): Sets a component to move right by one pixel;

(Move Up by One Pixel): Sets a component to move upward by one pixel;

(Move Down by One Pixel): Sets a component to move downward by one pixel;

(Left): If the text content exceeds two lines, the text lines will align to the left(also applicable to components).

(Align Right): If the text content exceeds two lines, the text lines will align to the right (also applicable to components).

(Align Top): Sets multiple components in top alignment mode.

(Align Bottom): Sets multiple components in bottom alignment mode.

(Vertical Center): If the text content exceeds two lines, the text will be arranged in the vertical center alignment mode (also applicable to components).

(Horizontal Center): If the text content exceeds two lines, the text will be arranged in the horizontal center alignment mode (also applicable to components).

(Equal Width): Sets equal width for multiple components.

(Equal Height): Sets equal height for multiple components.

(Equal Size): Sets equal size for multiple components.

(Top): Sets a component to be located in the topmost layer.

(Bottom): Sets a component to be located in the bottommost layer.

(Group): Includes multiple components into one group.

(Ungroup): Dissects the grouped parts into multiple discrete parts.

(Equal Horizontal Space): Sets equal horizontal space for multiple components.

(Equal Vertical Space): Sets equal vertical space for multiple components.

(Flip Vertical): Flip up/down.

(Flip Horizontal): Flip left/right.

(Rotate for 90°): Rotate for 90 degrees counter-clock wisely.

- **Tag Position toolbar**



Some component has a tag on it. By default, the tag is in the center of the component. But when the component has been stretched or resized, the tag may no longer lay in the center. To position the tag more precisely, click the tag to select it, then the tag position tools are enabled. The tools listed here are: Align the tags to the left, to the right, to the top, to the bottom, align horizontal midline and align vertical midline.

- **Drawing toolbar**

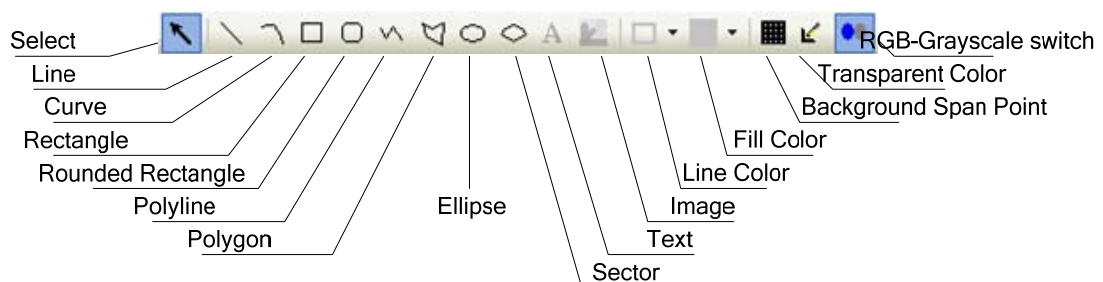

The contents of the drawing toolbar are arranged in the following order:

- Select:** Selects a single component;
- Straight Line:** Draws a straight line;
- Curve:** Draws a curve;
- Rectangle:** draws a rectangle;
- Rounded Rectangle:** Draws a rounded rectangle;
- Polyline:** Draws a continuous straight line;
- Polygon:** Draws a polygon;
- Circle/Ellipse:** Draws a circle/ellipse;
- Sector:** Draws a sector;
- Text:** Adds a text;
- Picture:** Imports a picture to the bitmap library;
- Line Color:** Sets the color of a line;
- Fill Color:** Sets the filling color;
- Background Spacing Point:** Sets the background spacing point;
- Transparent Color:** Implements transparent color effect of an added bitmap;
- Gray Scale:** switches the bitmap between color and gray.

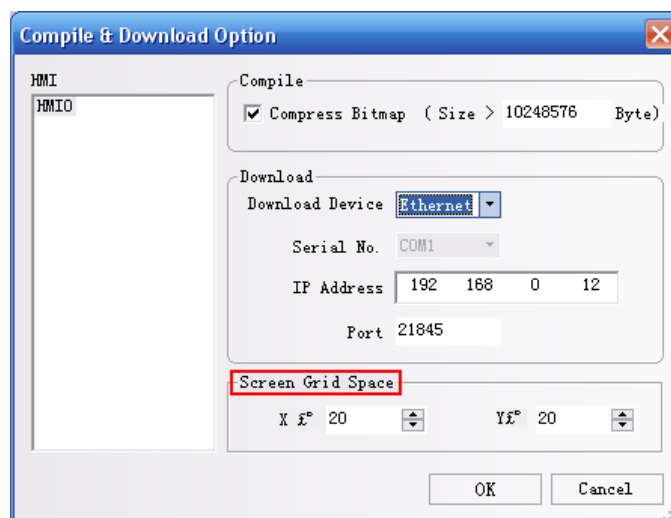

In the palette of color-related tools, we provide 40 optional colors, as shown in the following figure:

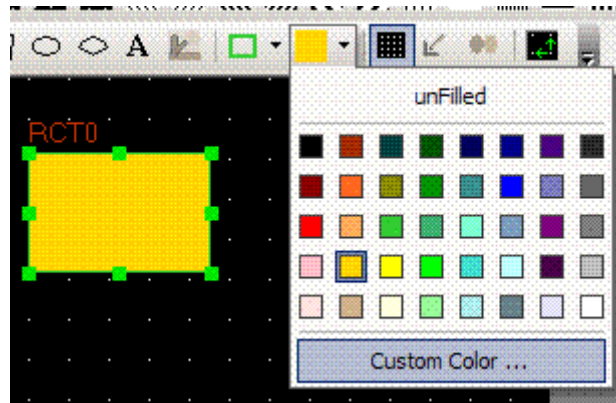

In addition, besides the 40 colors listed above, you may make a customized setting of the color. Select **Custom**, and the following dialog box appears:

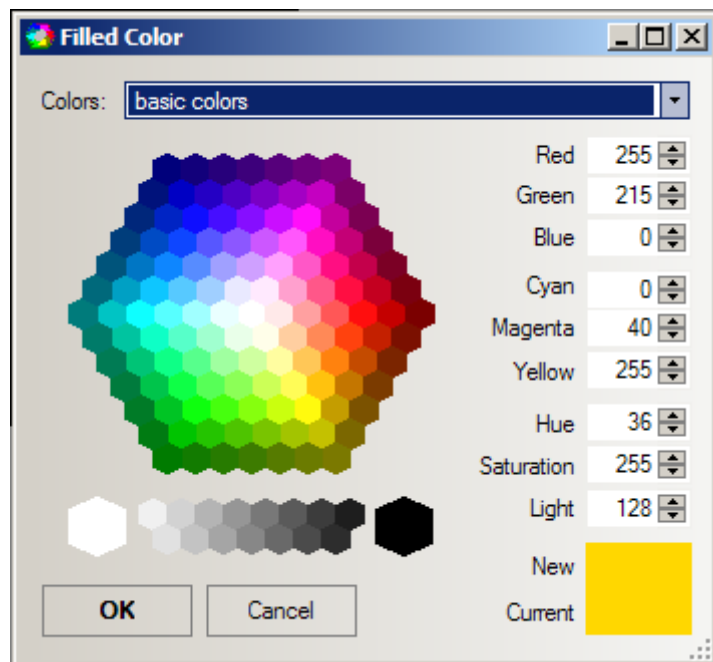

In this dialog box, you may customize any shape color you want. we provide more color schemes in the color properties list.

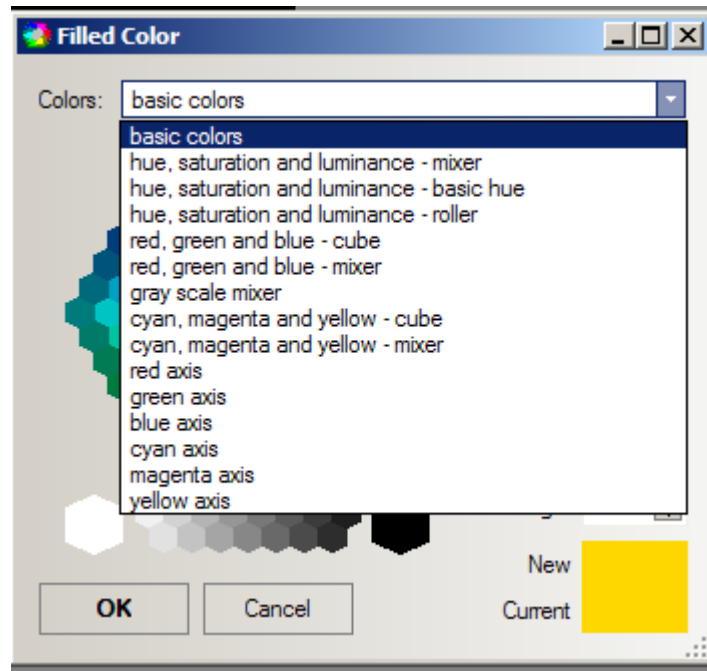

The users can customize their own color when needed.

● **Selecting components**

Methods for using selecting components:

1. **Directly select:** Click a component to be selected directly;
2. **Select all components:** Select **Select All Components** in the **Edit** menu, and all components in the current screen will be selected.

When the direct select tool is activated, Click a component, with the Ctrl key hold will make a copy of the component .



Note: To select multiple components or to enter the multiple selecting mode, drag the mouse and select at least one part, then press and hold the **[Shift]** key, additional parts can be selected.

● **Modifying part size**

You can click a component to change its size in the following method: Click to select a part, select anyone among the eight green pints of the component, and drag with your mouse, as shown in the following figure:

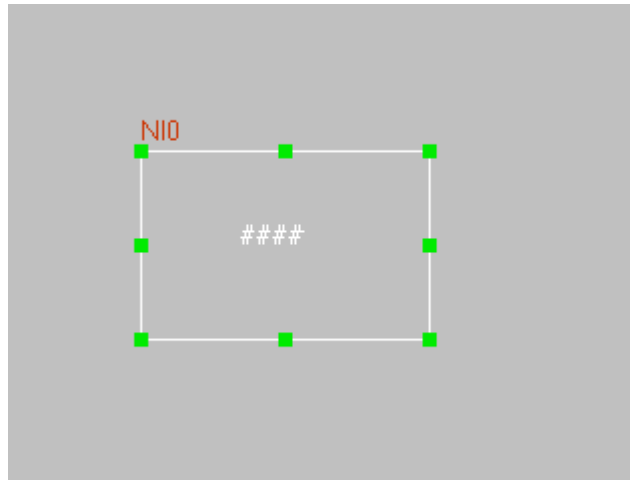

- **Part Fill and Frame:**

To change the change the color of the part outline or the filling color, select a component, and click the arrow after  **Line Color** icon to change the frame color. To change the fill color, click the arrow after the black box, as shown in the following figure:

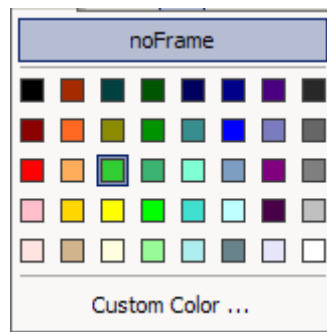

- **Text**

Click the text icon , the text dialog box appears, as shown in the following figure:

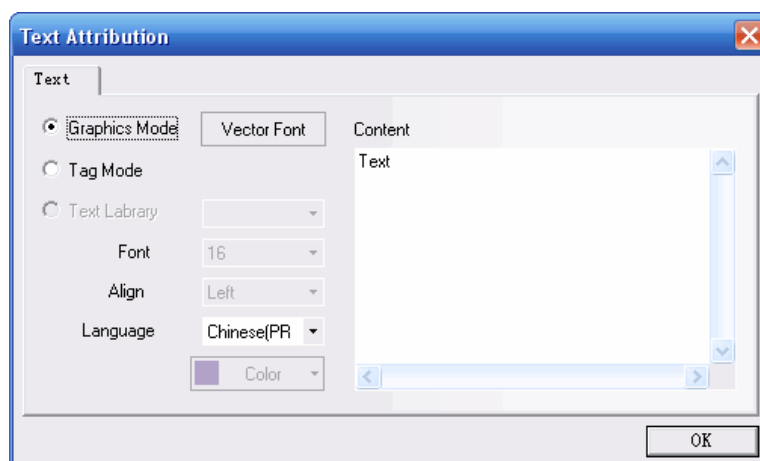

Content: Shows the text contents on the parts. When entering text, you can press the **[Enter]** key to start a new line.

Graphics Mode: In this mode, you can change the font size, font, font style, and so on. Click

Vector Font to show the font property setting dialog box, as shown in the following figure:

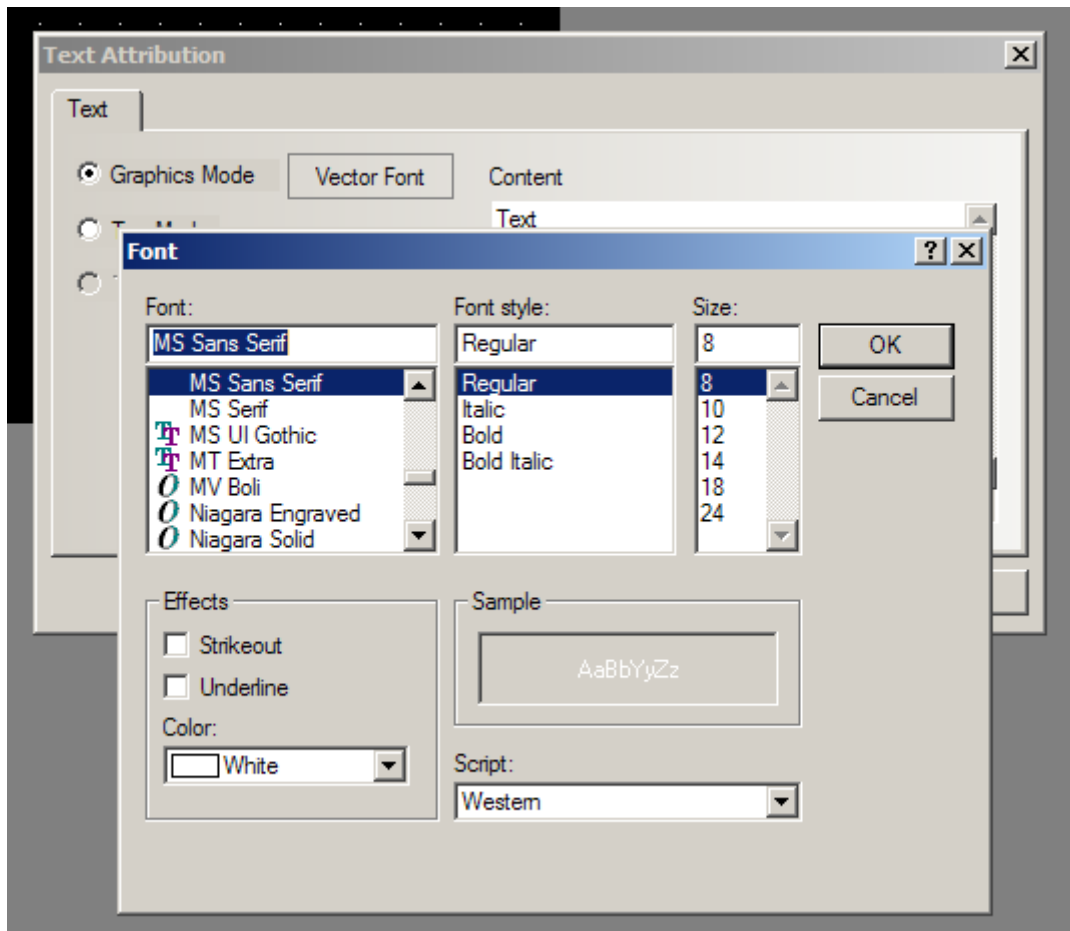

Tag Mode: In this mode, you can only change the font size, align mode and color.

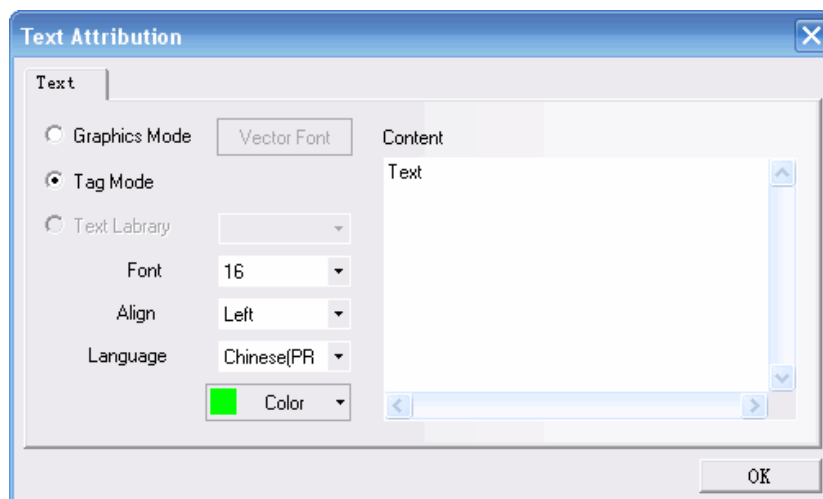

Text Library Mode: In this mode, you can use the text pre-defined in the text library.

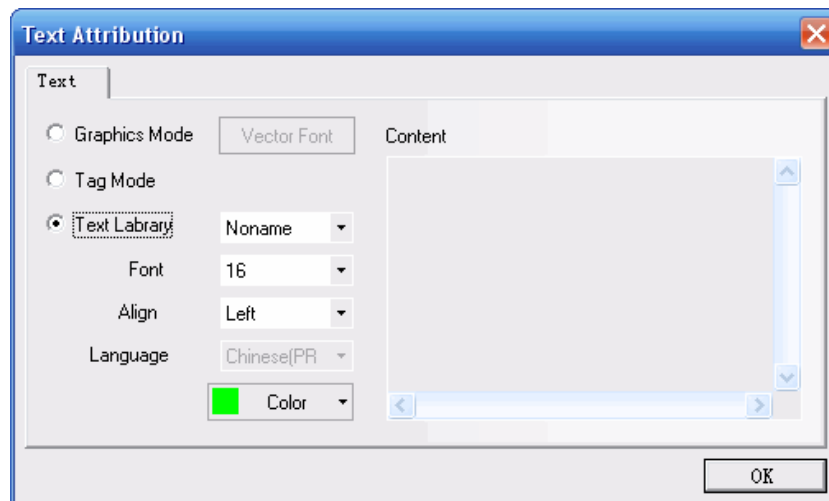

Font Size: 8, 16, 24, 32, 48, 64, 72 and 96 pixels are optional.

Align: The text alignment mode can be **Left**, **Right**, and **Center**.

Color: Indicates the text display color.

Content: Shows the text content on the part. When using the text library, the text content can only be edited in the text library. For detailed description of the text library, refer to Section 6.33 in Chapter 6.

- **Picture** 

This icon can be used to add pictures when creating bitmaps. For related contents, refer to Section 5.6, “**Bitmap**”.

- **Switch page Toolbar**

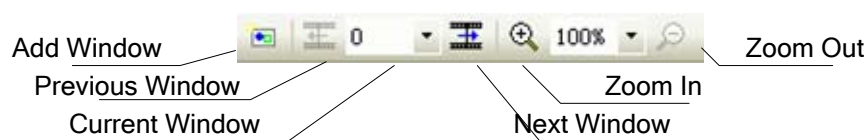

Add Window: Adds a configuration window;

Previous Page: Goes to the previous configuration window;

Current Page: Shows the current configuration window;

Next Page: Goes to the next configuration window;

Zoom in: Zooms in the current window;

Zoom Multiple: 100%, 200% and 300% are optional

Zoom out: Zooms out the current window.

- **Line style toolbar**

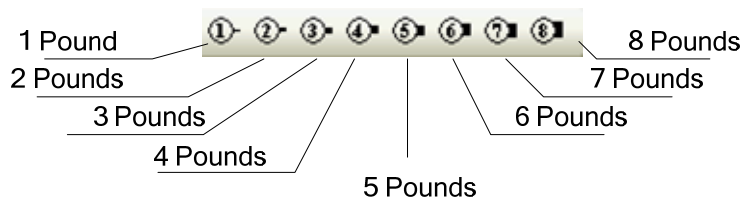

It is used to select the line width, the number indicates the pounds of the line width.

● **System toolbar**



Compile: Compiles the current project and checks whether there is any error. Projects have to be compiled before download or simulation, or the download and simulation tools are disabled.

Download: Downloads a project to the HMI panel;

Offline Simulation: Used for offline simulation of a project;

Indirect Online Simulation: Used for indirect online simulation of a project;

Direct Online Simulation: Used for direct online simulation of a project;

● **Code editing toolbar**

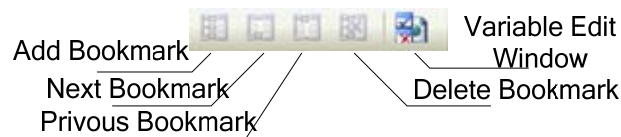

Add Bookmark: Creates a new bookmark;

Next Bookmark: Shows the next bookmark;

Previous Bookmark: Shows the previous bookmark;

Delete Bookmark: Deletes a bookmark;

Variable Edit Window: Opens or closes the variable edit window.

● **Fill Effect Toolbar**



It is used to select various filling effect shapes. The filling patterns above can be used for shapes like rectangle, ellipse and sector. The background of configuration window can also be filled with these patterns.

To fill the current window, double click the window to show the properties window. Select **(Use Background Fill Effect)**, as shown in the following figure:

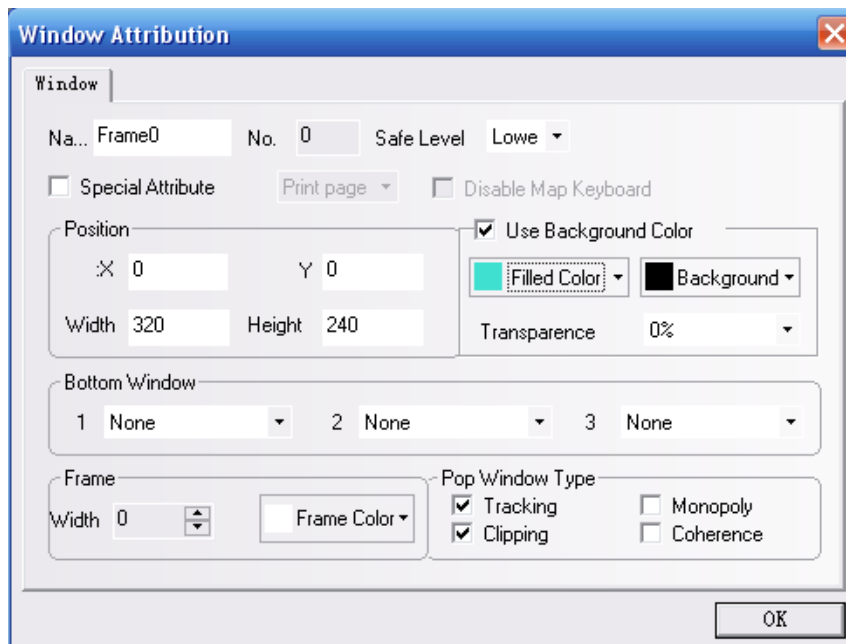

Select a fill color and background color, and then select a fill style, as shown in the following figure:

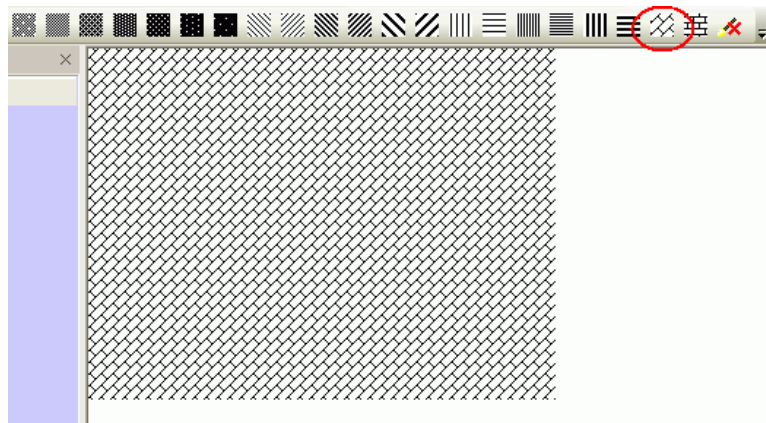

To fill a shape, select the shape to be filled, then click one of the above fill style icons. The method is the same as that for filling a window. The only difference is that, for a component, the line color is the line color of the pattern, while the fill color is the pattern background color, as shown in the following figure:

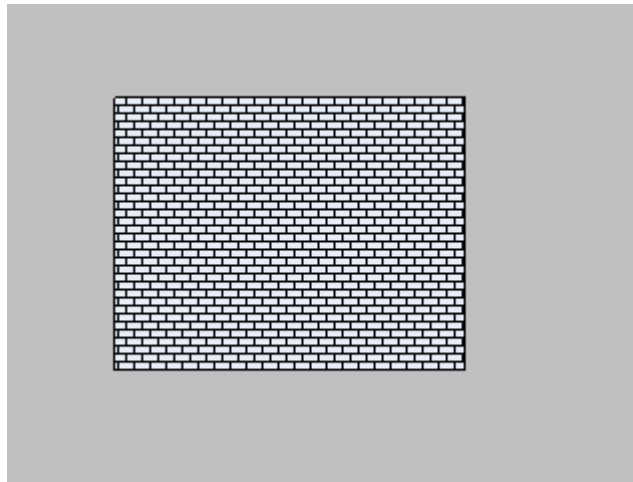

- **Status bar**



The status bar shows the current mouse position, the width and height of the selected object, edit state, and other state information.

3.1.4 Tools Menu

As shown in the following figure, for the contents of the **(Tools)** menu, please refer to related descriptions in Sections 3.5, 3.7, 3.8 and 3.9.

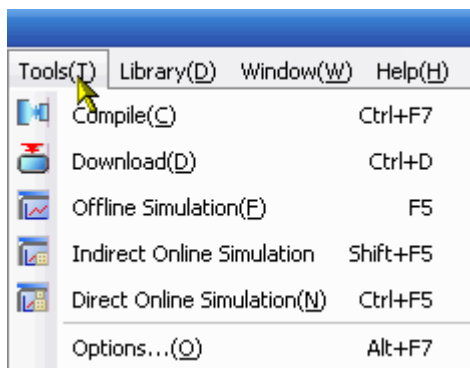

3.1.5 Project Database

As shown in the following figure, the **Library** menu provides eight items. For the details, refer to related descriptions in Chapter 5 and Chapter 6.

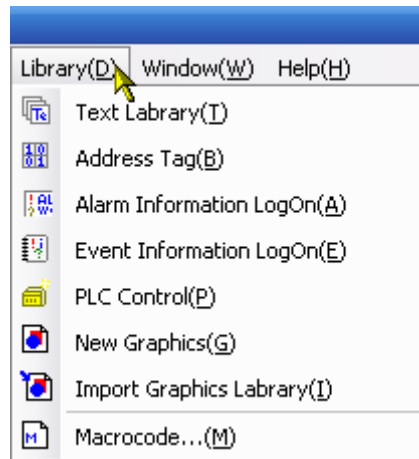

3.1.6 Window

Click **Window** in the main menu bar, and the following dropdown menu appears. The functions of **Cascade**, **Arrange Icons**, **Tile** and **Tile Vertical** are respectively as follows: **Cascade** is used to display windows in a cascade sequence, **Arrange Icons** is used to arrange various icons, **Tile** is used to display a window in tile mode, and **Tile Vertical** is used to display a window in vertical tile mode.

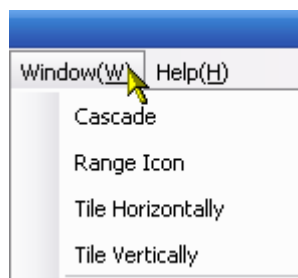

The **Tile** window is shown as follows:

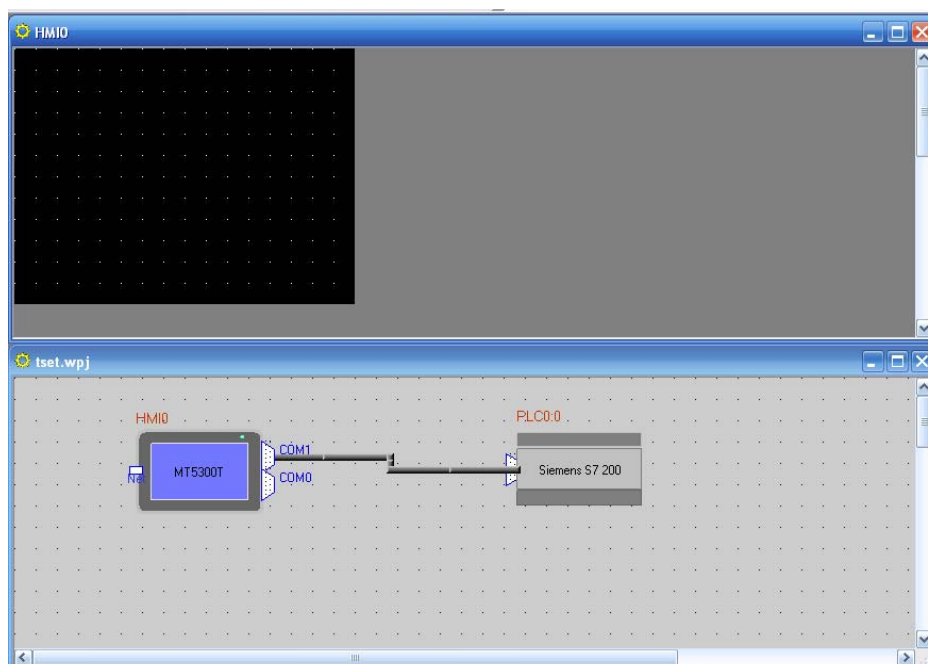

The **Tile Vertical** window is shown as follows:

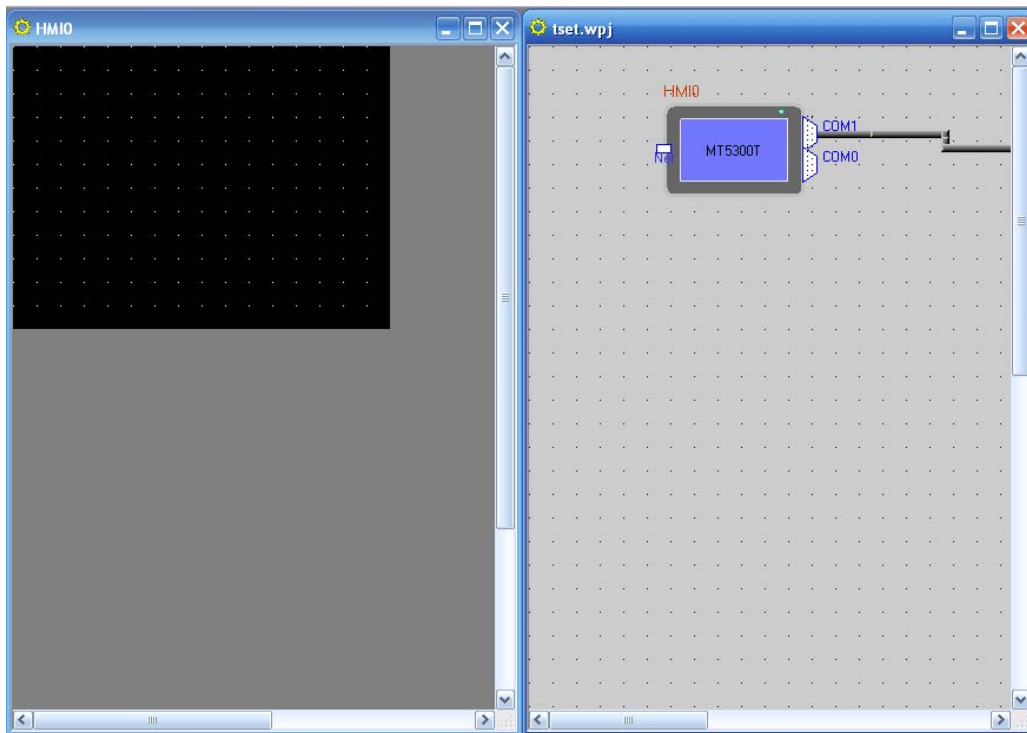

3.1.7 Help

Users can find software version information here.

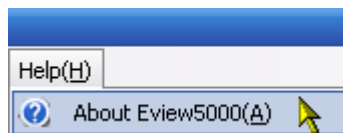

3.2 Graph element Window

By default, there are three important windows displayed within the EV5000 user interface. They are not real “windows”. The definition of “window” will be described in the next chapter. The

“window” here refers to a special area related to all components of a project. The three “windows” provide global information of the whole project. The three windows are, **Graph element Window**, **Project File Window**, and **Project construct Window**, which will be described one by one in the following.

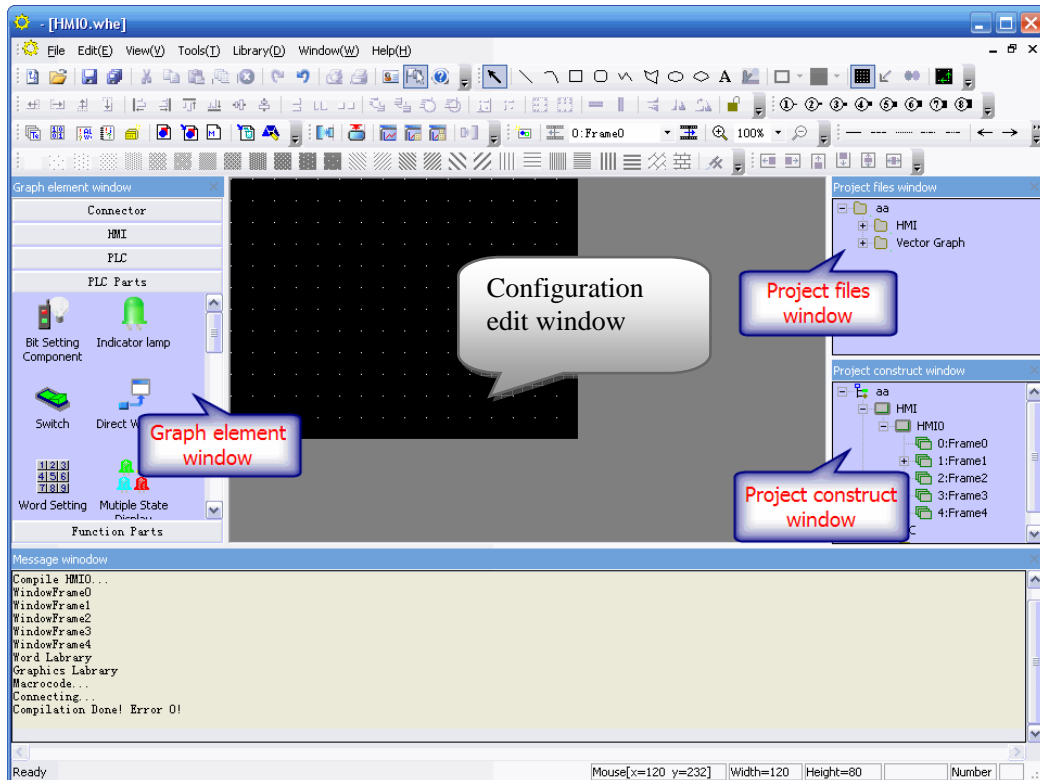

The **Graph element Window** includes (**Connector**), (**HMI**), (**PLC**), (**PLC Parts**), and (**Function Parts**).

(Connector): Includes serial port connection (**Serial**) and Ethernet connection (**Ethernet**).

(HMI): All models of eView MT4000 and MT5000 series HMI panel are listed here, the users should select the proper model in accordance with the actual panel for their projects;

PLC: All the PLCs supported by eView HMI panel system are listed here; the user should select the proper model in accordance with the actual PLCs for their projects;

(PLC Parts): All the parts related to PLC registers are listed here, including **Bit Setting Part**, **Switch**, **Multi-state Display Part**, **Trend Graph Part**, **XY Plot Part**, **Numeric Input Part**, **Text Input part** and so on;

(Functional Components): Parts for special functions are listed here, including **Function Key Part**, **Scale Part**, **Alarm Bar Part** and **Timer Part**

Usage:

(1) **Connector:**

If you select **RS232** or **RS485**, click [**Serial**] icon, drag it to the **Project Window**. If you want to use the Ethernet connection, click the Ethernet icon then drag it to the Project

Window. When dragging, the icon will appear like a wire. After dropping it, the wire will stay in the Project Window.

(2) **HMI:**

Identify the model of the actual HMI panel you are currently using, click the corresponding icon and drag it to the **Project Window**.



Caution: Make sure that the selected HMI model is consistent with your hardware model.

(3) **PLC**

Identify the model of PLC currently being used, click the corresponding icon and drag it to the **Project Window**.

After selecting the PLC, HMI and communication connection, connect them properly. (Drag the PLC and HMI icon to make the wire ends attached to the ports automatically. Click and drag the wire ends towards the ports will yield the same result. To make sure the connection is established, drag the HMI or PLC icon, the properly attached wire ends will move with the mouse.)



Note: If there isn't any PLC or HMI in the Project Window, the Project File Window and the Project Construct Window will be blank, as shown in the following figure:

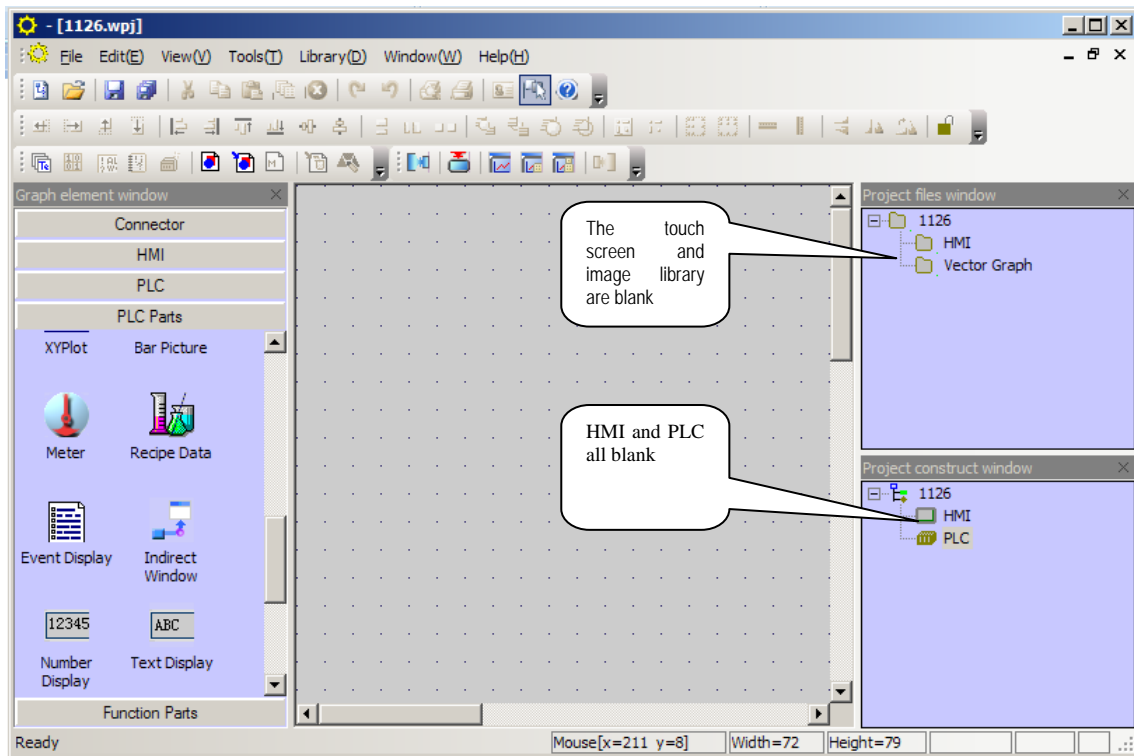

Once the PLC and HMI icons are dragged into the project window, related information will be displayed in the **Project File Window** and **Project Construct Window**, as shown in the following figure:

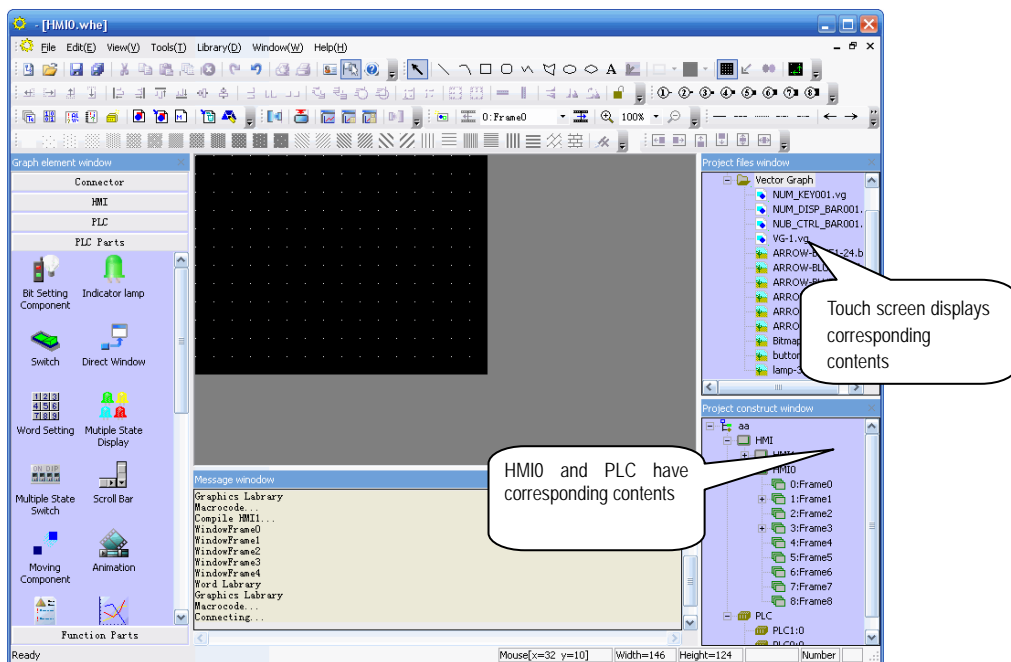

(4) **PLC parts**

It includes various configuration parts, as shown in the following figure:

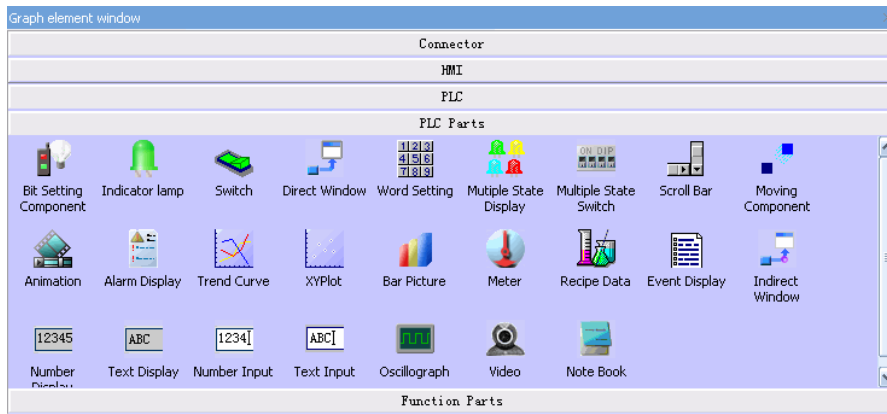

After creating a project and switch to the configuration screen edit window, you can drag parts to be used into the configuration window. For the detailed instruction for using the PLC parts, please refer to Chapter 6.

(5) Function Parts



Function parts include **Function keys**, **Scale**, **Alarm Bar**, **Timer**, and so on. For the usage of them, please refer to Chapter 6.



Caution: In the **Graph element Window**, right click, and select **Small Icon** in the shortcut menu, the icons will be displayed in the form of smaller icon, which can save the window area for small displays, as shown in the following figure:

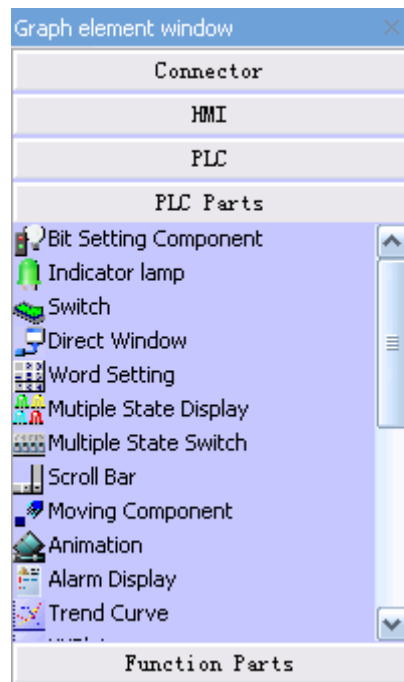

3.3 Project File Window

Files related to shape library and HMI panels are displayed in the **Project Files Window**, so there are two branches in the tree structure: HMI and Graphic Library.

HMI:

The HMI folder contains *.whe file which is corresponding to the HMI icon in the Project Window, For the first HMI panel, HMI0, the file is HMI0.whe, for HMI1, the filename is HMI1.whe. If there are three HMI panels in the project, there are three *.whe files, HMI0.whe, HMI1.whe and HMI2.whe. Double click the *.whe file will expand it, macrocode file and recipe file attached to the HMI panel will appear.

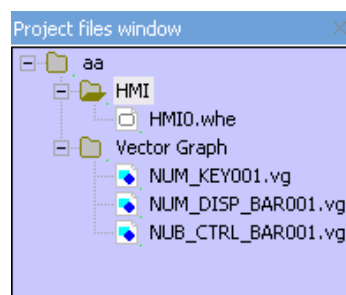

Click the symbol "+" or "-" in the left of the icon to expand or collapse the directory tree.

To edit the file in the folders, double click it.



Caution: The configuration recipe file (.RCP) can only be imported and deleted, but cannot be edited. To edit such a file, use other binary editing software.

Shape Library:

Shape Library folder contains all the vector graph and bitmap files imported to the current project. Vector graph files are shown as *.vg files and bitmap files are shown as *.bg files. For the description of vectogram and bitmap, please refer to Sections 5.5 and 5.6 in Chapter 5.

3.4 Project Window and Project Construct Window:

The **Project Window** is used to show the structure of the entire project. HMI panels, PLCs and connection wires are shown in this window, as shown in the following figure:

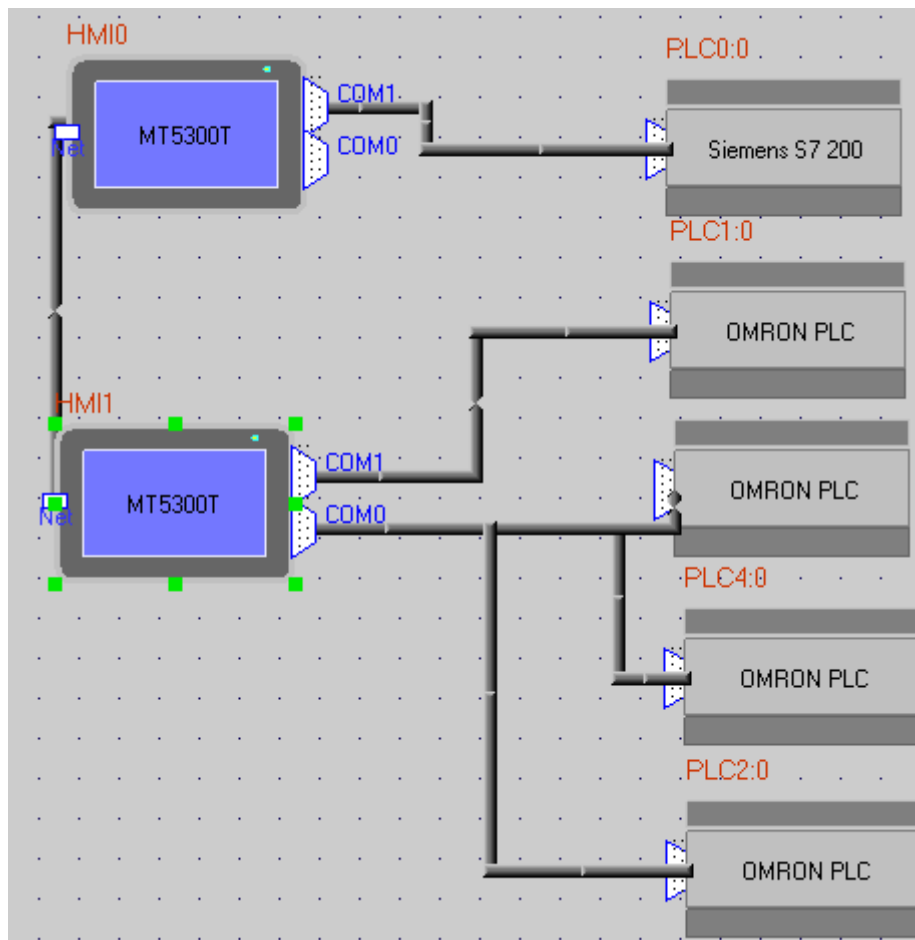

HMI: One HMI icon represents one actual HMI panel, the number after HMI helps the user distinguish those panels. Right click on the HMI icon will popup its own shortcut menu, the user can select in the menu to take expected operations on the corresponding panel.

PLC: One PLC icon represents one actual PLC. The number after PLC helps the user distinguish those PLCs. Right click on the PLC icon will popup its own shortcut menu and the user can select in the menu to edit the attribution of the corresponding PLC.

Wire: The wires shown in the Project Window represent the physical connection between HMI and PLC. See page 59 for detail of connecting HMI and PLC.

The structural diagram is as follows:

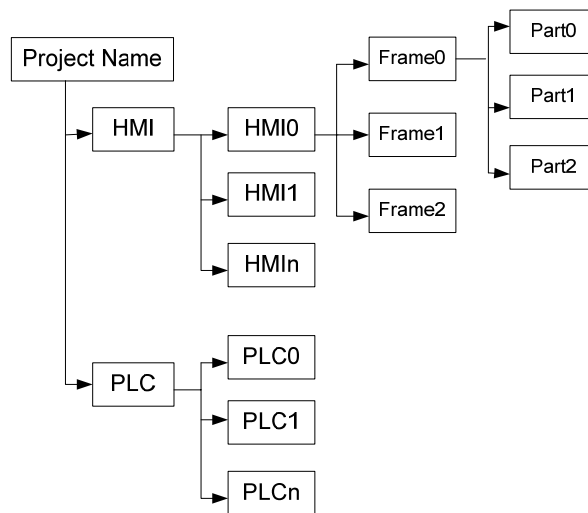

The detailed structure is shown in the **Project Construct Window** as follows:

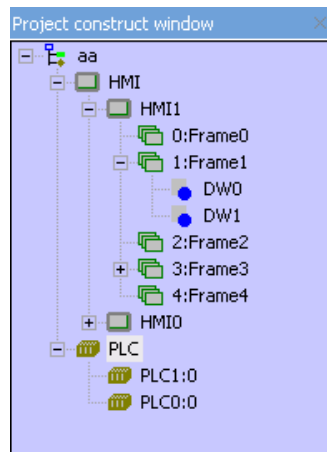

See the figure above, the icons labeled “FrameX” represent the configuration windows of panel marked as HMI1. “DW0” and “DW1” in the above figure represent parts in Window 1. The “+” symbols indicate windows containing parts, click on the “+” will expand the tree and make the parts of that window visible. Windows containing no parts don’t have that “+” symbol and can not be expanded. To collapse the expanded tree, click on the “-” symbols. If the user want to delete some windows or parts, click to select and press DELETE key on the keypad, the selected frame or part will be deleted.

PLC Attribution:

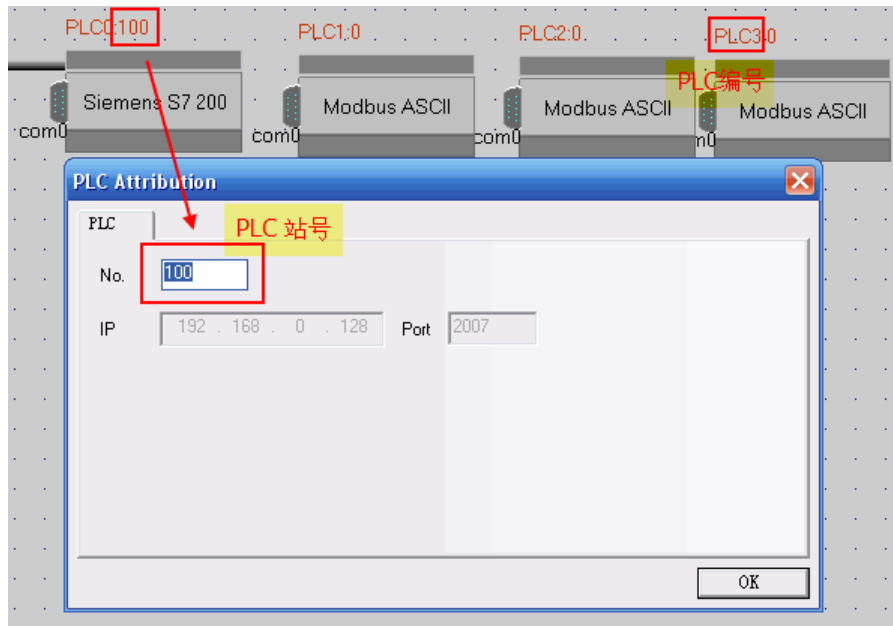

The first digit indicates the number of PLC, that is, the number designated to the PLC.

The digit after the colon indicates the station number of the PLC.

3.5 Compile Information Window

The **Compile Information Window** displays the compile progress and the compiling results, indicates the errors when they occur, as shown in the following figure:

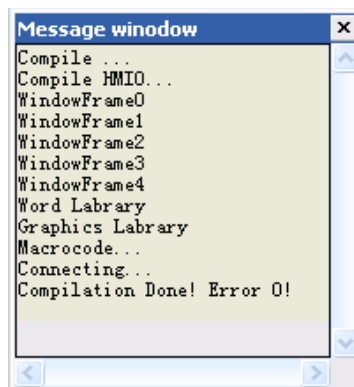

When a project is open, the Compilation Information Window will display the loaded information of the project. When a project is being compiled, the Compile Information Window will display the compilation progress and error messages if there are any.

3.6 Component List Window

Select **Component List Window** under the **View** menu to open the **Component List Window**.

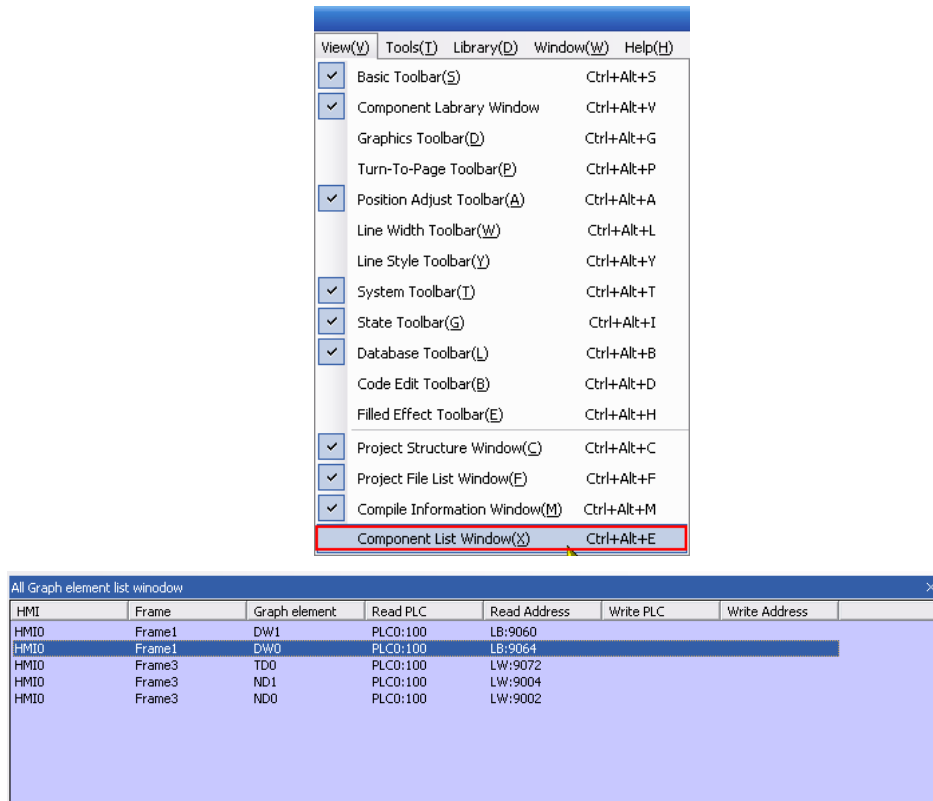

The window shows the information of all parts used in the project, including HMI panel number, configuration frame number, part number, input PLC number, type of input address, input address, output PLC number, type of output address and output address. Double click an entry will lead to the configuration frame where the part is.

3.7 Offline Simulation

The EV5000 provides offline simulation function. During offline simulation, the program does not acquire data from the PLC, but only read data from the local address. Therefore, all data displayed on the configuration windows are static data. With the offline simulation, the user can conveniently preview the configuration effect, without the need to download the program to the touch screen every time. Therefore, lots of time for downloading is saved.

Select **Offline Simulation** in the **Tools** menu, or click the  icon, the following dialog box appears:

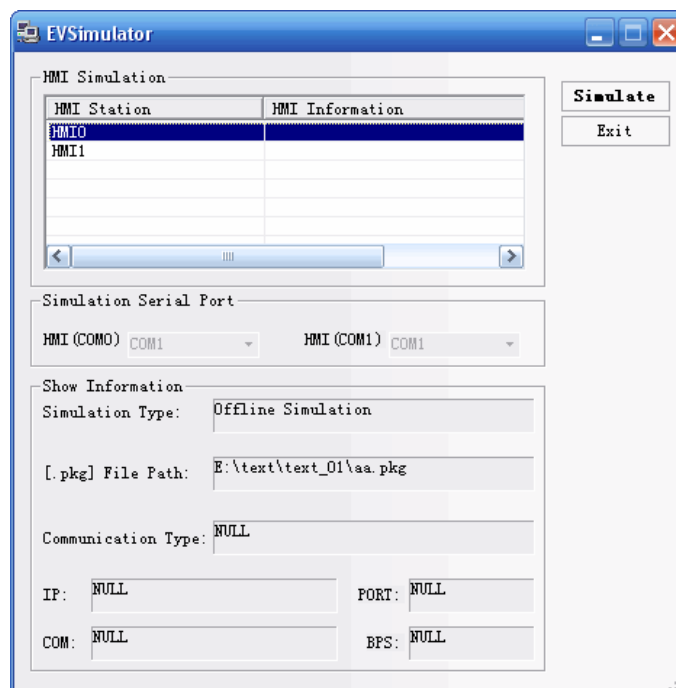

Select an HMI to be simulated, and click **Simulate**, the offline simulation screen of the selected HMI panel appears.

3.8 Online Simulation

The EV5000 provides online simulation operation. With the online simulator, a project can be simulated on the PC and the configuration simulation screen acts as the actual panel. The simulator exchange data with the PLC (via MT4000/5000 HMI panel connected to the PC in the indirect mode). The data displayed on the simulator screen is the actual data from the PLC registers. Using online simulator when debugging the configuration project can save much time for downloading. The online simulation function has two modes: direct and indirect, which will be explained in detail in the following paragraphs.

3.8.1 Direct Online Simulation

In direct online simulation mode, the PLC is directly connected to the serial port of PC running the simulator. Its merit is that the PLC data can be obtained dynamically, without the transfer and possible delay of the HMI panel. The user can even create and evaluate the configuration project without an actual panel on hand, which can save the cost for a potential client who just want to try before purchasing. The shortcoming is that only the PLC with an RS232 interface can be used in this mode. To debug the PLC with an RS485 interface, an RS232-to-485/422 interface convertor is required.

Note:

1. The maxim test time for the direct online simulation is 15 minutes. After 15 minutes, the system will prompt “simulation timeout, please simulate again”, and the simulator will shutdown automatically.

2. Only the RS232 communication mode can be used for direct online simulation. After the compiling configuration project and establishing the physical connection between PLC and

PC, click the  button, the following dialog box appears:

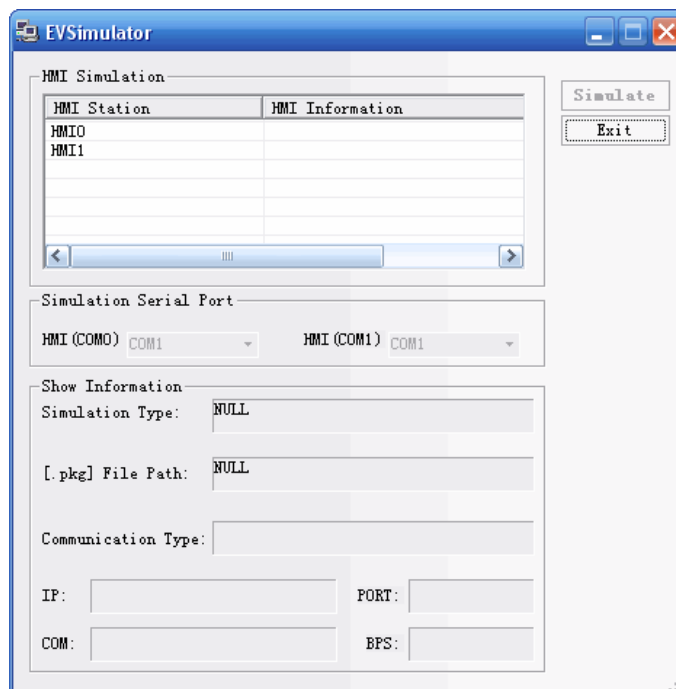

Select the touch panel to simulate, select the COM ID of the computer to be connected to the PLC, and click **[Simulate]** to start direct online simulation.

Note: Use the programming cable of PLC to connect PLC and PC and perform the simulation.

3.8.2 Indirect Online Simulation

In indirect online simulation mode, the simulator exchanges data with the PLC via the HMI panel connected to PC. The simulation screen acts as the actual panel, clicking on the screen is the same as touching the real panel. With indirect online simulator, lots of time for downloading is saved. The user has to have the proper panel to perform the simulation. Connect the panel to PC with USB cable or MT4000/5000 downloading cable or Ethernet cable. Connect the PLC to the panel with the required communication cable. For more information about the communication cable, refer to chapter 14.

After the compiling the project and connecting the PLC, HMI panel and PC properly, click the  button, the following dialog box appears:

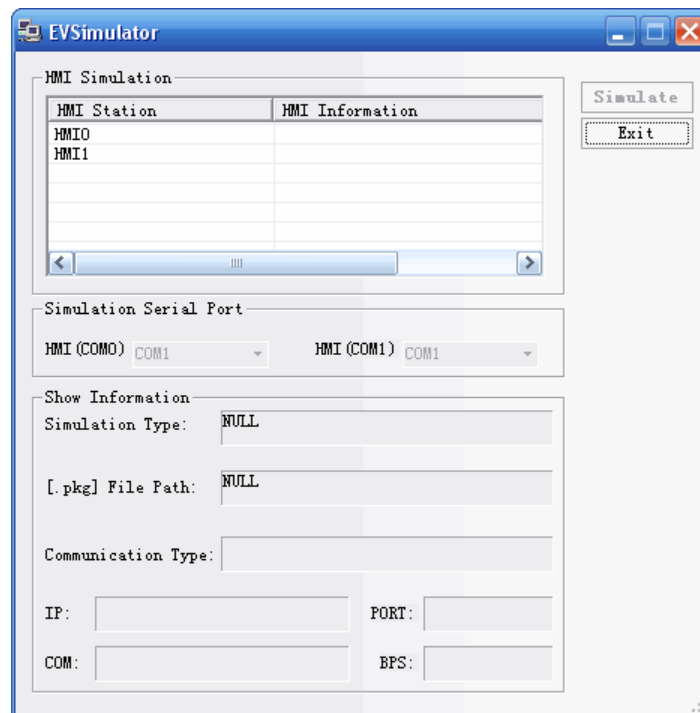

Select an HMI to be simulated, click **[Simulate]** to start simulation.



Note:

1. The MT5000 panels can perform indirect online simulation via the Ethernet, USB or serial port.
2. The MT4000 panels can perform indirect online simulation via the USB or serial port.

3.9 Download

After a project is compiled, it can be downloaded to the touch panel for actual operation. The MT5000 panels provide three download methods: USB, Ethernet and serial port. The MT4000 panels provide two download modes: USB and serial port. Downloading via the Ethernet is the fastest way, while downloading via the serial port and USB is a bit slower. Before download/upload, the users must set the communication parameters first. Set the communication parameters in the **Setting Option** submenu in the **Tools** menu in the menu bar, as shown in the following figure:

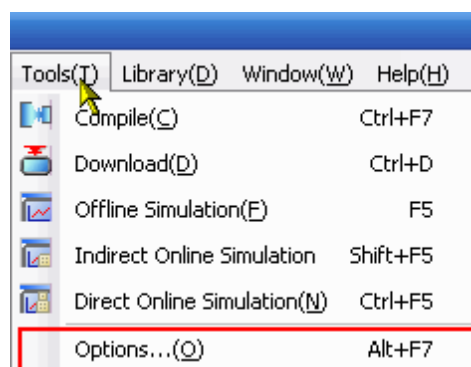

Then, the following dialog box appears:

1) Download through USB cable

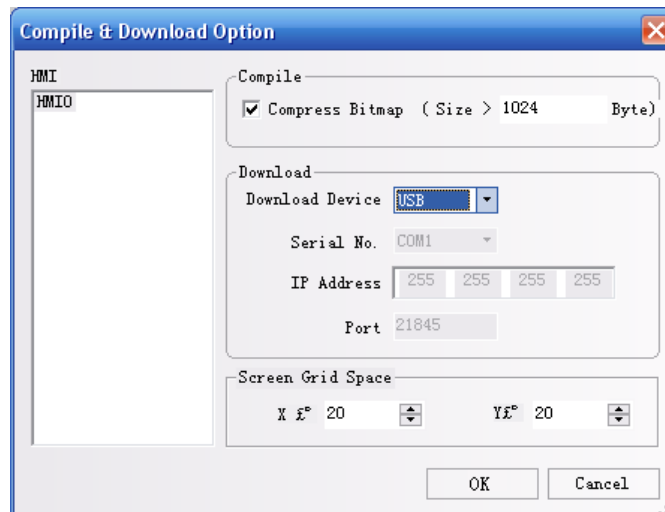

A USB cable is included in the package of MT5000/4000 panel. Connect MT5000/4000 panel to the USB port of the PC with that cable before download.

- The USB-client port on the MT4000/5000 panel can only be used for uploading/downloading configuration package file and the logo file or setting the system parameters of the HMI panel. Other USB devices such as printers and USB mass storage devices are not supported.

When using USB downloading cable for the first time, the user should install the USB device driver manually. Connect the panel and the PC with the cable first, power on the panel. The windows OS will report that the system had just found a new hardware and start the wizard as the following figure shows. The user can finish the installation by following the instruction below.

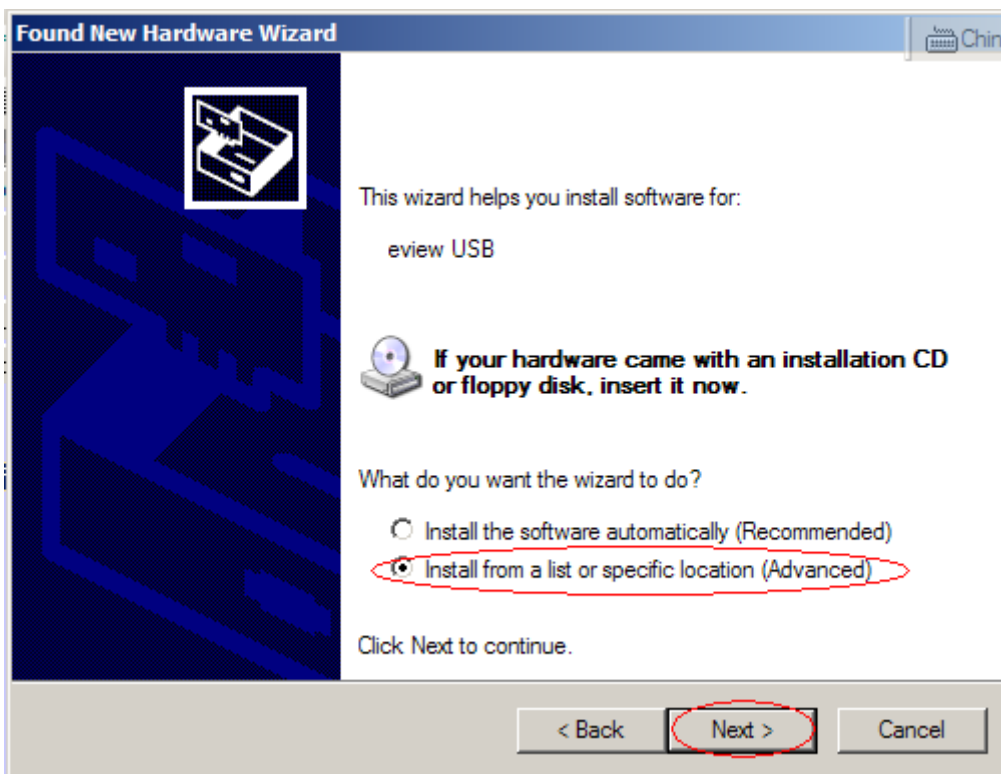
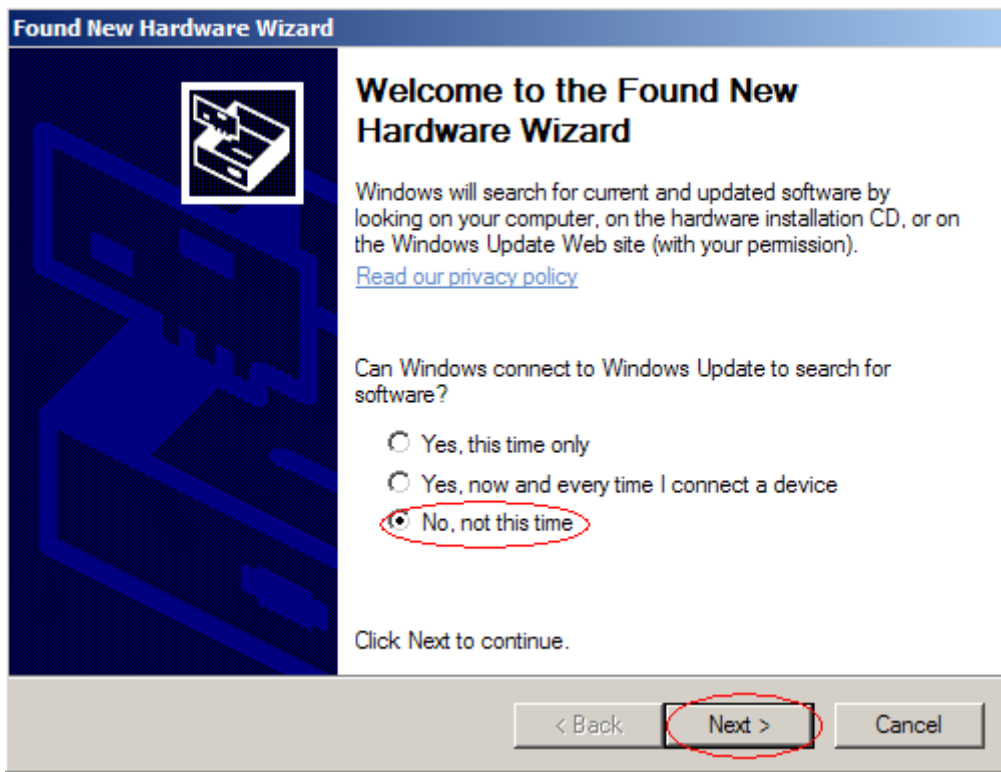

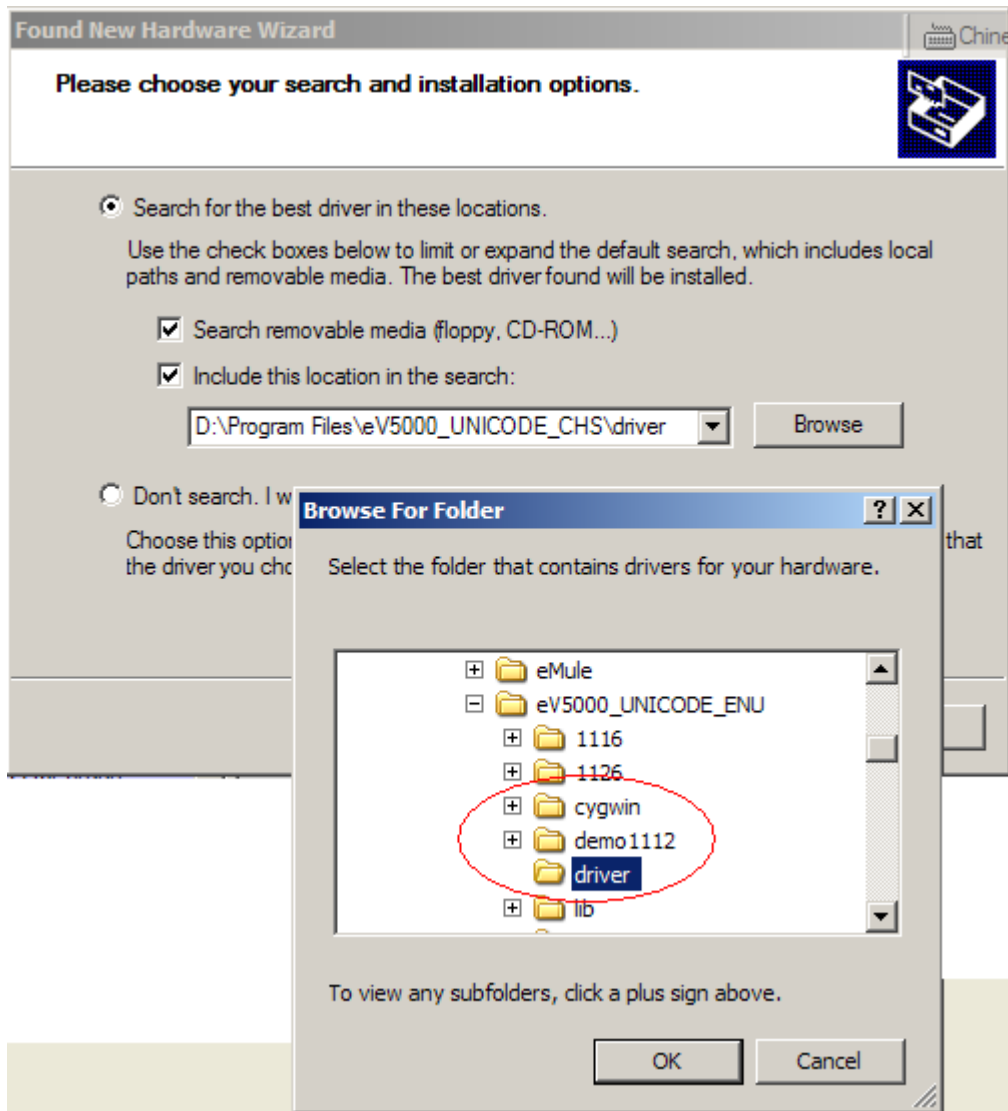

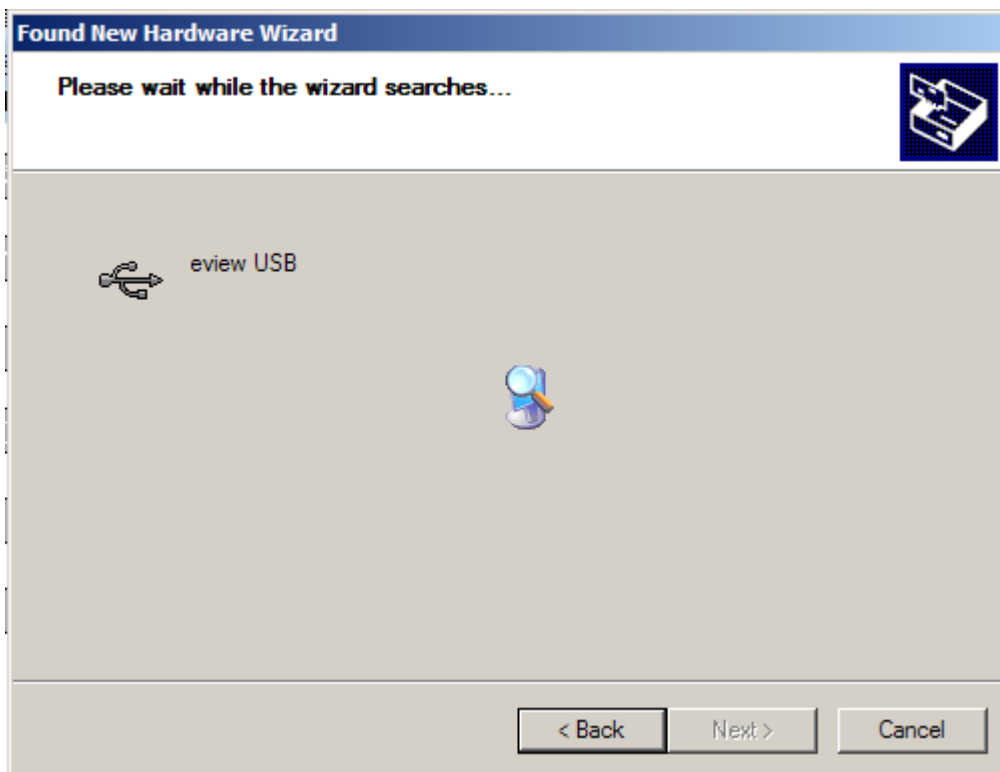
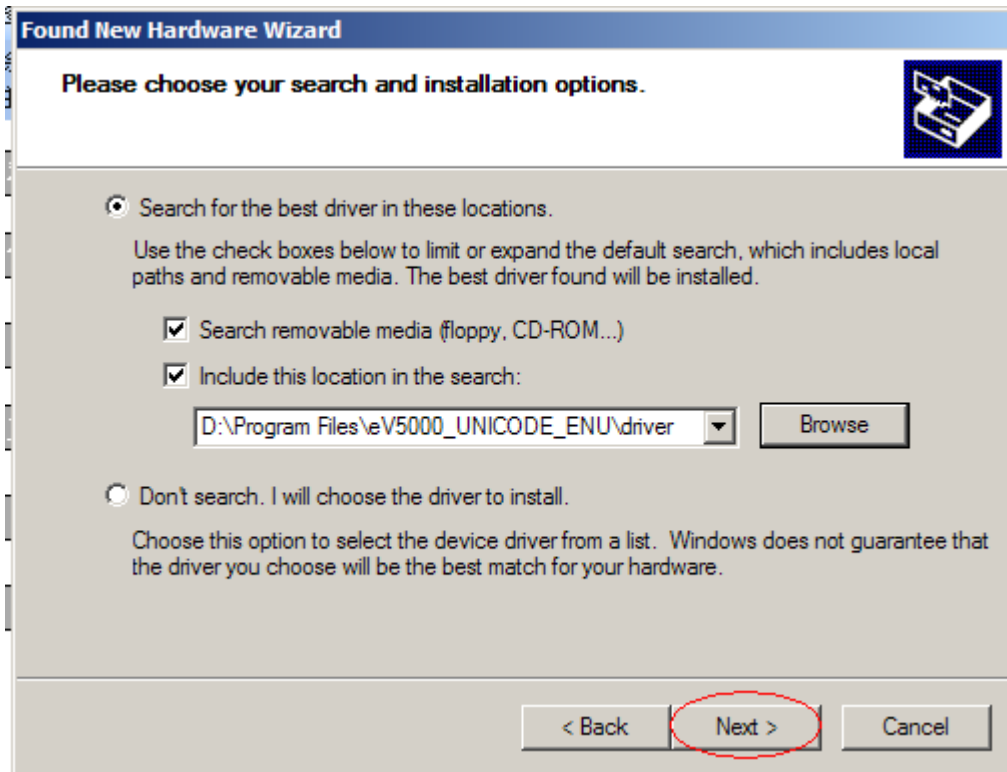

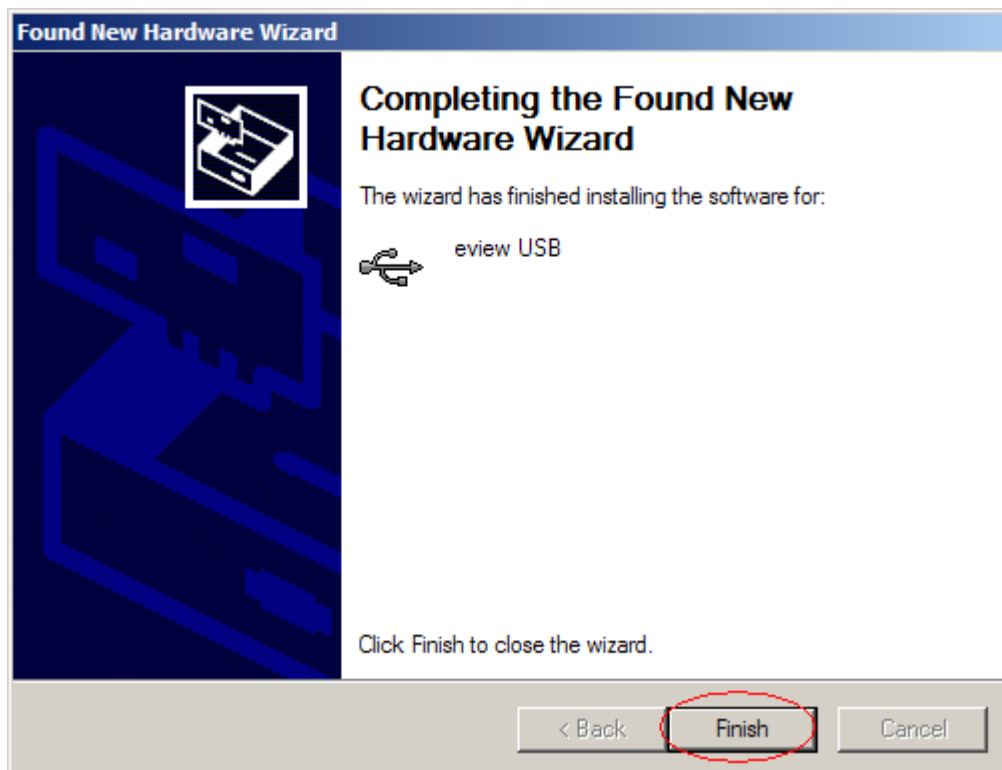
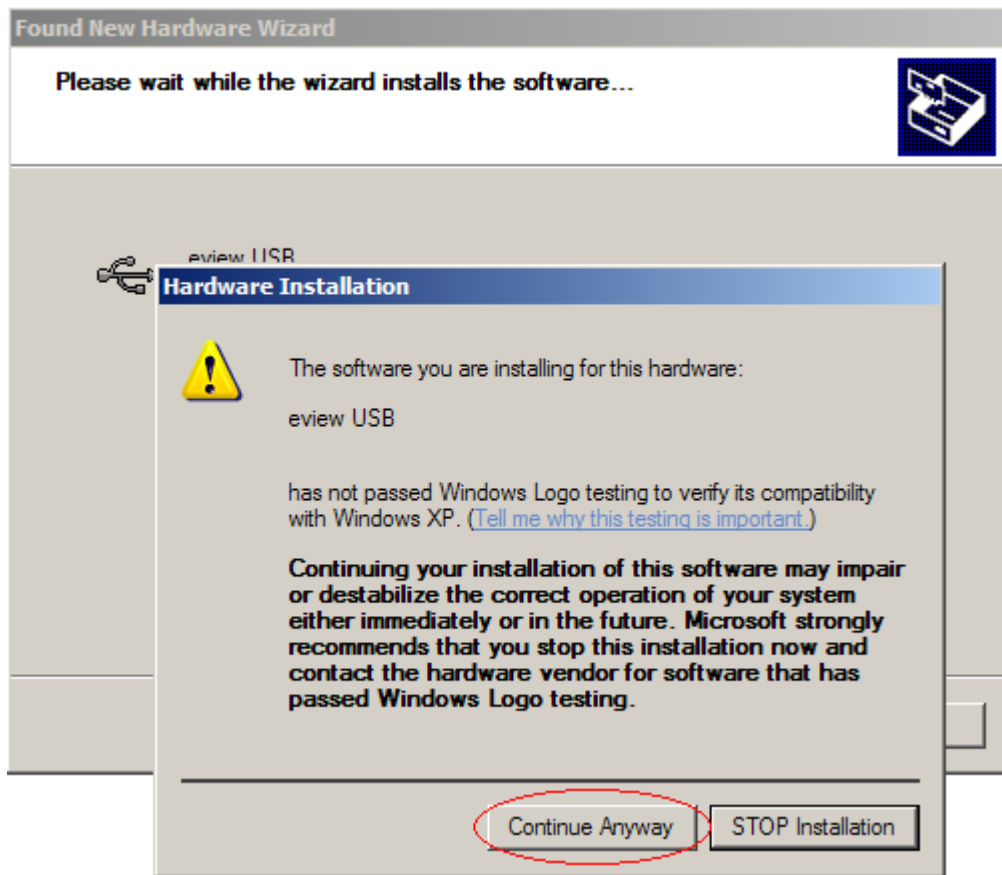

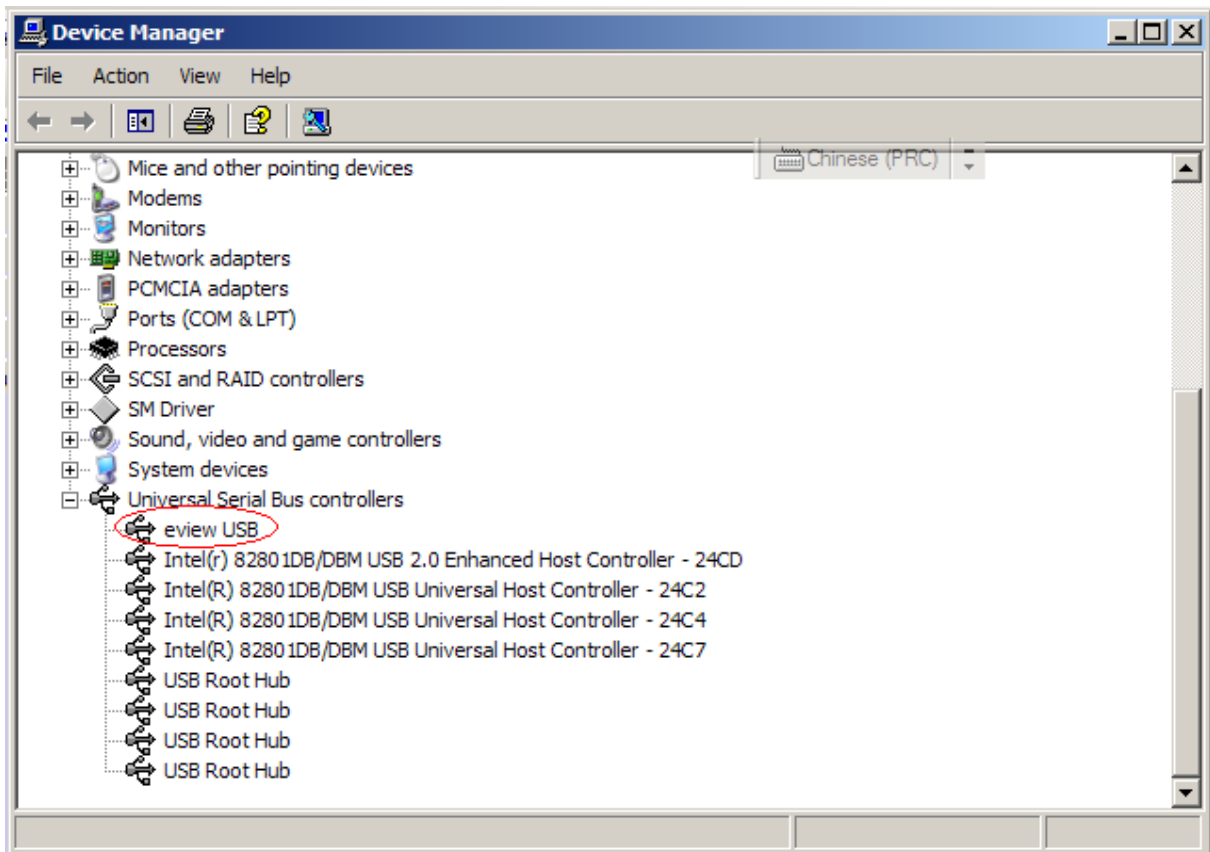

Once the driver is installed successfully, the user can select **My Computer** → **Properties** → **Hardware** → **Device Manager** → **Universal Serial Bus Controller** to check whether the USB device is connected to and identified by the PC, as shown in the following figure: (The **EVIEW USB** appears only when the DIP switches 1 and 2 in the rear of the touch panel are set to “**OFF**”.) To configure the DIP switches, remove the lit on the back of panel.



Once the driver has been installed successfully, no more settings is needed. The user can use the eView USB device after connecting and powering on the panel. To download through USB cable, select “USB” for **Download Device**, as shown in the following figure:

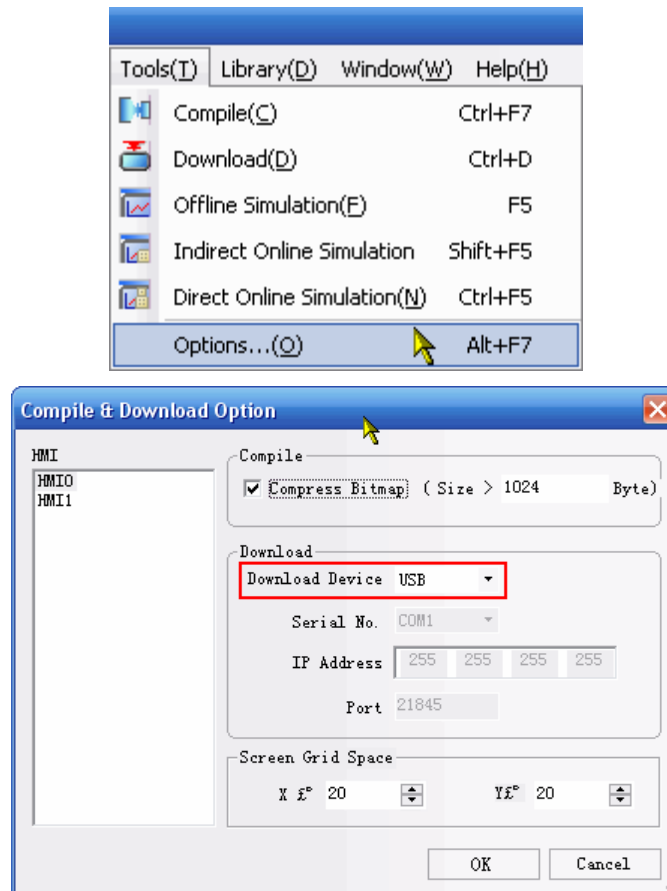

Compress Large Bitmap: In the numeric input box, the user can specify the limit of the original file size of the bitmap which is imported into the project. The file size is counted by bytes. When the bitmap file exceeds that limit, the compiler will compress the bitmap for downloading. Compression will save the storage space on the panel. This option is selected by default.

2) Ethernet (For MT5000 panels only)

The Ethernet interface can be used for the downloading of the HMI configuration, the setting of the HMI system parameters, and the indirect online simulation of the configuration. Furthermore, multiple HMIs can be interconnected via the Ethernet to form a multi-HMI application.

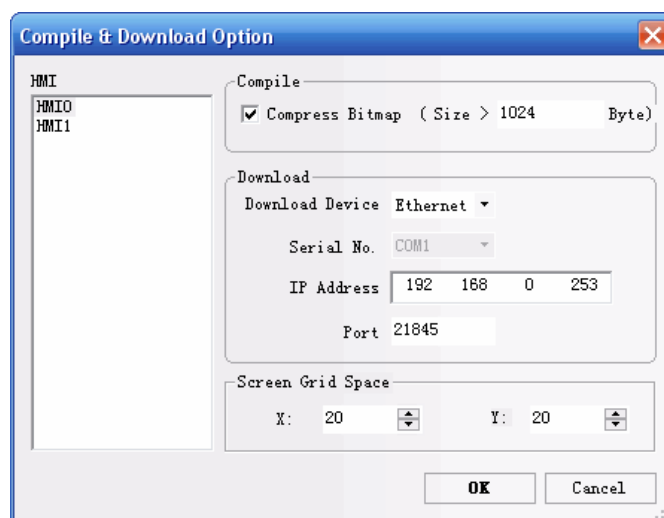

[IP 地址] (IP Address): Refers to the IP address of the HMI to be downloaded. In addition to this IP address, the IP address of the PC should also be set. The two IP addresses should be in the same network section, that is to say, the range of the IP address of your PC is: 192.168.0.1 ~11/13 ~ 255. To implement normal download, the IP address of the HMI should be different from that of the PC.

[端口号](Port No.): A network is actually composed of seven layers of protocols. One of the most important tasks of the Transport Layer is to provide a reliable end-to-end connection. Where, the “end” here means the port. Of course, there are many ports, ranging from 0 to 65535. The TCP/IP protocol has many ports. All the ports less than 1024 have clear definitions. You are recommended to use ports above 1024. Set such a port to a port used for the touch screen. Anyway, please make sure that your PC allows the use of this port. The setting procedure for the PC port is as follows:

Network Connections (right click) → **Properties** → **Local Area Connection** (right click) → **Properties** → **Internet Protocol (TCP/IP)** → **Properties** → **Advanced** → **Options** →

Enable TCP/IP Filtering → Properties

For details, refer to the following figure:

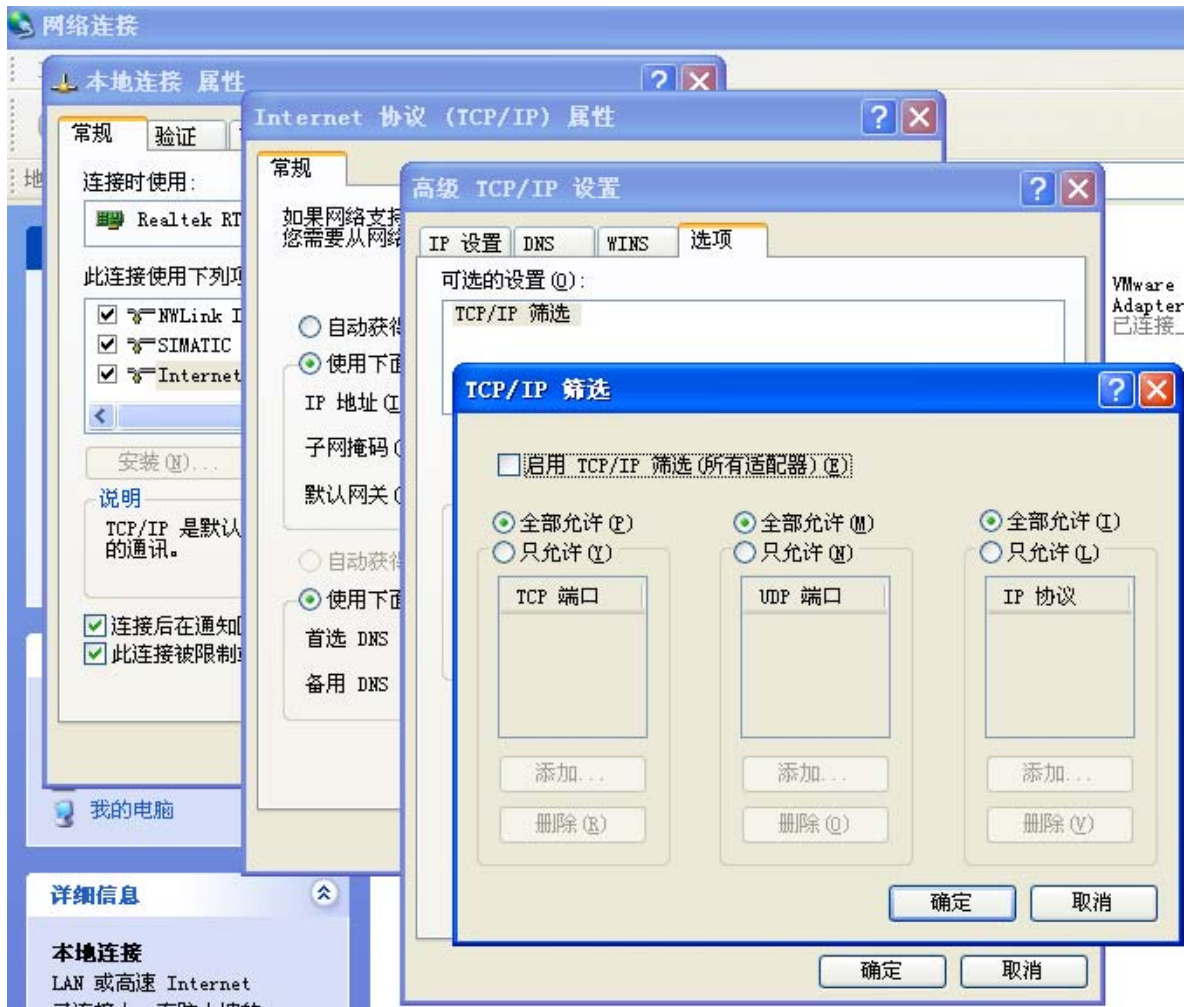

Caution: 1. Normally, the port number does not need modification.

To change the port number, the port number in the Setting Option in the [Tools] menu should not be the same as that in the Project Structure Window and HMI Properties, as shown in the following figure:

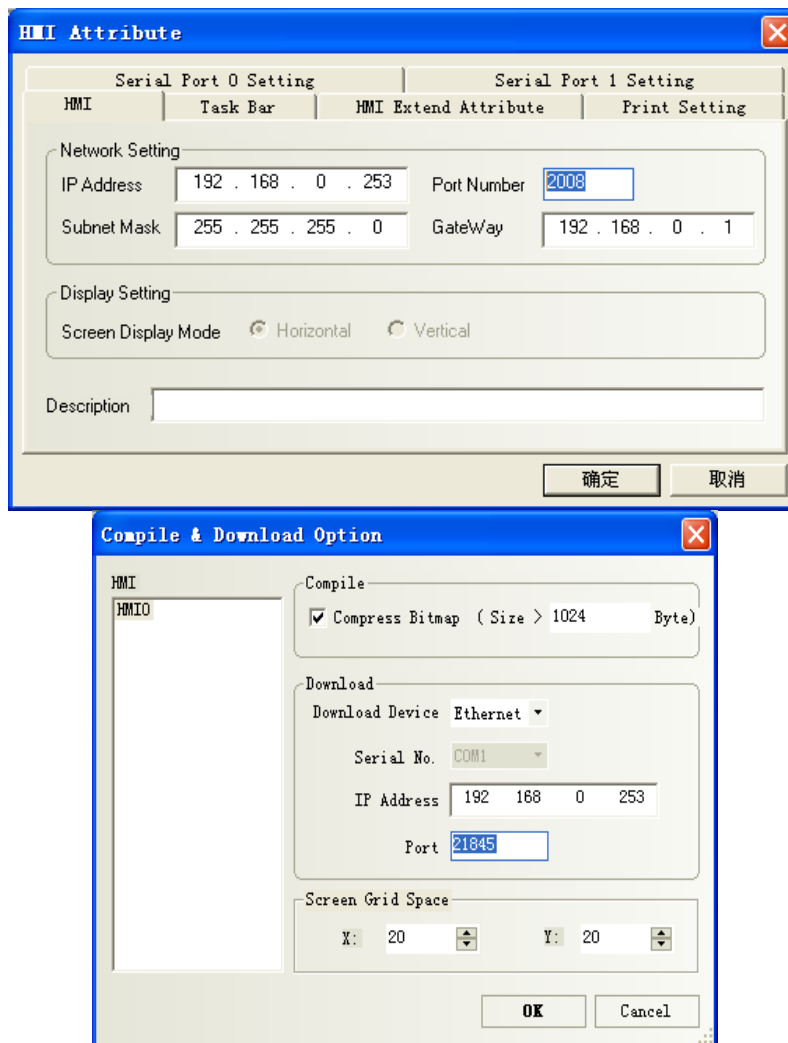

2. This port can be connected to a HUB or a SWITCH via a standard Ethernet cable (RJ45 straight-through cable) to access the LAN (Local Area Network), or can be directly connected to the Ethernet port of the PC via an interconnection cable (RJ45 cross-over cable).

The network interface of the PC is directly connected to the touch screen via a cross-over cable. Then, it is connected to the touch screen through the HUB via a straight-through cable.

3. If a user has enabled the firewall, an alert box will appear to ask which port the user wants to access. Select "**Enable**", and download can be made. If all ports are disabled, disable the firewall.

4. The touch screen is directly connected to the network interface of the PC, and the IP address of the PC should be changed to an address different from that of the touch screen. If the IP address of the touch screen is 192.168.0.253, then IP address of the PC should be changed to 192.168.0.X. The first three digits should be the same, and the last digit should be different.

2) Downloading through Serial port

To use serial port as the downloading method, select "Serial Port" in the list, as the following figure

shows:

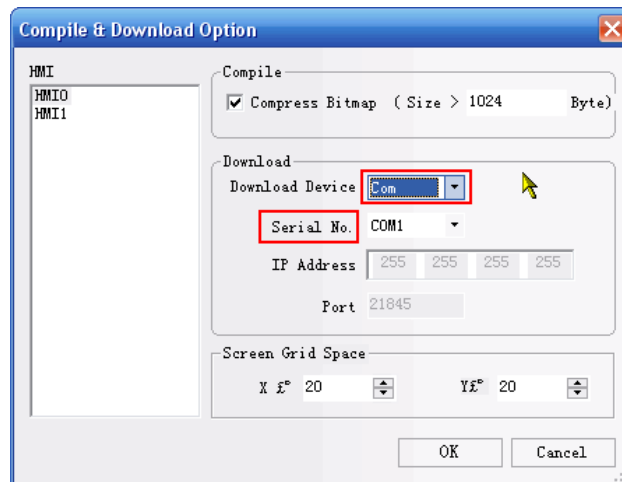

Serial Port No.: Select a serial port you want to use. Make sure the port you designate is available and the downloading cable is connected properly. The user can contact with Stepservo Ltd or local distributor to get the serial downloading cable.

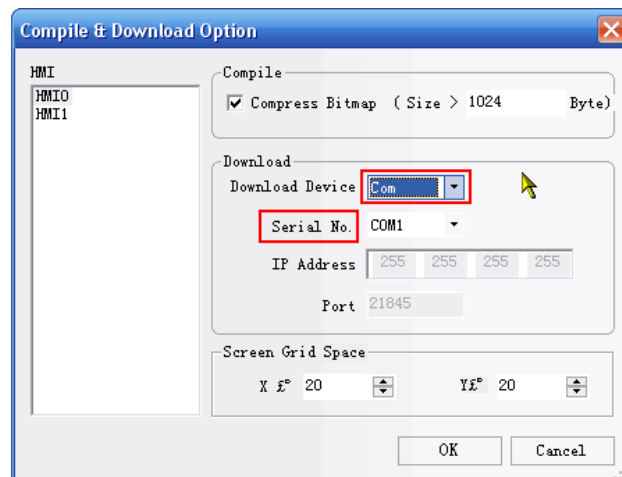
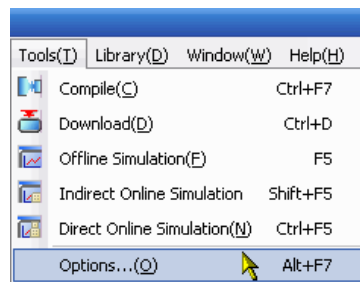

Note: Due to the low downloading speed, downloading through serial port will take a long time to wait, thus it is not recommended as the downloading channel.

After selecting the downloading method and setting the required parameters, you can start

downloading by click the icon . A dialog box will pop up after clicking the download icon.

According to the method you select, the dialog box looks a bit different, as the following figures

show:

The screenshot shows the EVDownload software window. The 'Select HMI' table has 'HMI0' selected. The 'Download File Path' is 'E:\text\text_01\aa.pkg'. The 'Communication Type' is 'USB port'. The 'Select Section' panel has 'Data File' checked. The 'Download' and 'Exit' buttons are visible.

HMI Station	HMI Information
HMI0	
HMI1	

Download File Path: E:\text\text_01\aa.pkg

Communication Type: USB port

IP: NULL PORT: NULL

COM: NULL BPS: NULL

Select Section:

Data File

Recipe File

LOGO File

Download

Exit

The screenshot shows the EVDownload software window. The 'Select HMI' table has 'HMI0' selected. The 'Download File Path' is 'E:\text\text_01\aa.pkg'. The 'Communication Type' is 'Serial port'. The 'Select Section' panel has 'Data File' checked. The 'Download' and 'Exit' buttons are visible.

HMI Station	HMI Information
HMI0	
HMI1	

Download File Path: E:\text\text_01\aa.pkg

Communication Type: Serial port

IP: NULL PORT: NULL

COM: COM1 BPS: 115200

Select Section:

Data File

Recipe File

LOGO File

Download

Exit

The screenshot shows the EVDownload software window. The 'Select HMI' table has 'HMI0' selected. The 'Download File Path' is 'E:\text\text_01\aa.pkg'. The 'Communication Type' is 'NetWork'. The 'Select Section' panel has 'Data File' checked. The 'Download' and 'Exit' buttons are visible.

HMI Station	HMI Information
HMI0	
HMI1	

Download File Path: E:\text\text_01\aa.pkg

Communication Type: NetWork

IP: 255.255.255.255 PORT: 21845

COM: NULL BPS: NULL

Select Section:

Data File

Recipe File

LOGO File

Download

Exit

Except the downloading-method-related parameters displayed in gray boxes, there are some options the users can set and should pay attention to.

Select Section

The files to be downloaded to the panel are of three types: User Data File, Recipe File and Logo File. The user can select any one of these files to be downloaded, which makes the downloading more flexible and avoid wasting time for unnecessary download. The following paragraphs give an introduction of these files.

User Data File: The configuration project files, including all the data of the configuration windows and images, are packaged into a single user data file after being compiled. The extension of the file type is .pkg. Only after the *.pkg file has been downloaded, the panel can run the configuration project designed by the user.

Recipe File: This option is only available when there is a recipe file imported into the project and affiliated to an HMI panel. The recipe file is stored in one SRAM chip on the mainboard of the panel, with a backup battery to keep the data when the power is off.

LOGO File: Logo is the first picture displayed during the power-on stage, when the embedded system has not been booted. So the picture is different from other pictures displayed in the configuration windows. By editing the initial window, the user can create his own logo file, whose expansion is *.logo. When the user want to change the current logo, he must edit the initial window in the project and compile the project, then select the Logo File check box and download the file to the panel. Once the logo file has been downloaded, there is no need to download everytime if the user doesn't want to change it. The logo will be displayed everytime the panel is powered on. By default, the checkbox for logo file downloading is unselected.

How to make your own logo?

Create a new project or open an existing one, make sure there is an HMI icon in the Project Window. Click the  icon on the toolbar, or right click HMI icon in the Project Window to enter the initial starting window edit window, as shown in the following figure:





By default, there is a logo picture of Stepservo Ltd in the editing window. The user can replace it with his own logo or other desired picture. To import an user-defined picture, click the  icon on the toolbar, and the following dialog box appears:

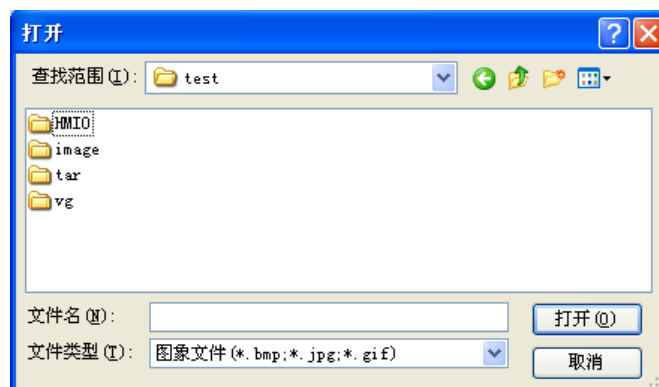

Find your company's logo image and click **Open**. The supported image format is bitmap, JPEG image and GIF image, and the image to be imported as the logo should not larger than the size of the panel. (For MT4300/5300, the size is 320*240, for MT4400/4500/5400/5500, the size is 640*480.) In the following figures, we use the logo of Stepservo as an example:



After selecting the image and click "Open", the logo image is imported into the editing window and you can adjust the size and position of it. When the adjustment is done, save it and close the

window to return to the project window. Connect the HMI panel and PC, compile the project and click “download” icon, the dialog box we have discussed above appears:

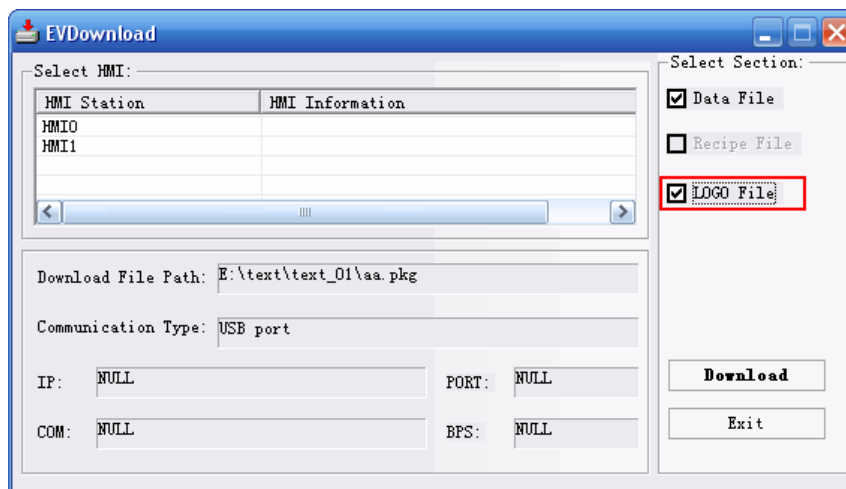

Select **LOGO File** checkbox and click **Download**. If the user only want to download the logo and don't want to download the user data file, unselect the User Data File checkbox.

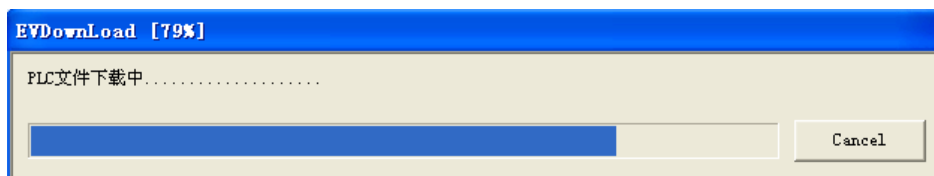

After the download is finished, click **[OK]**.



Reset the panel, it will show the logo just been downloaded during the power-on stage. If no logo file has been downloaded, the panel will display “LOGO Error!” instead.

Chapter 4 Configuration Windows

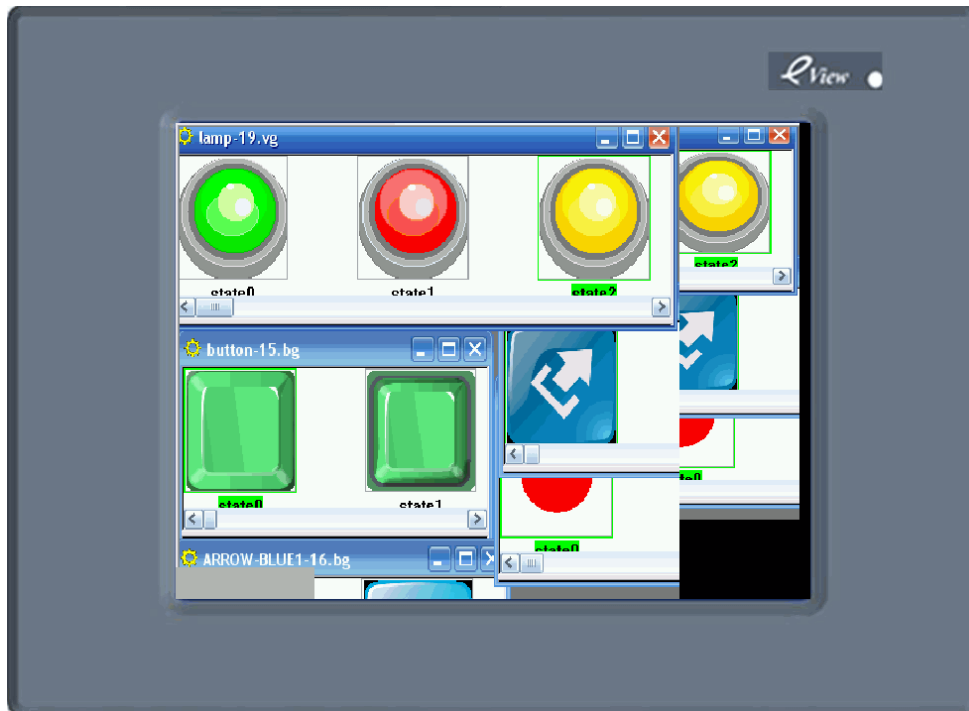

4.1 Window Type

Window is the basic elements of an EV5000 project. Each display is composed of a number of windows. There are three types of windows: Basic, common and fast selection. A basic window can be used as a pop-up window after changing its size. All windows can be assigned as underlay windows.

- Basic window:** Basic window is the normal type of window that would be displayed during HMI runtime. When using (Change Window) command to switch to a basic window, the current screen will be cleared (all windows except the common window and fast selection window will be turned off). When the parts in the base window invoke the pop-up window, the original information of the base window will be kept, while the invoked pop-up window will be attached to the current base window. The relationship between all such pop-up windows and the base window is a kind of father-son window relationship. Upon the switchover from base window N to base window M, all sub-windows of window N will be closed, while window M and sub-window of window M are displayed. The base window should be of the full-screen size.
- Fast selection window:** The fast selection window is a window activated by touching the task button. This window will be always displayed on the screen unless it's hided by a task button. So it can be used for placing function keys which switch over windows or other commonly

used objects. By default, Window 2 is the fast selection window. If another window is set to be the fast selection window, the window should be of the same size as the fast selection window.

- **Common window:** The common window will always be displayed on the screen. A part to be always displayed can be placed in the common window. Thus, you can view the state or operation of the component at any time. By default, Window 1 is the common window. The function key **Change Common window** can be used to change other window to be the current common window. However, there is only one current common window.
- **Bottom Window:** A maximum of three underlay windows can be set for the window in the **Window Properties** dialog box. Normally, the bottom window is used to store common components shared by multiple windows, such as background images, graphs, titles and so on. Any window can be set as a bottom window.

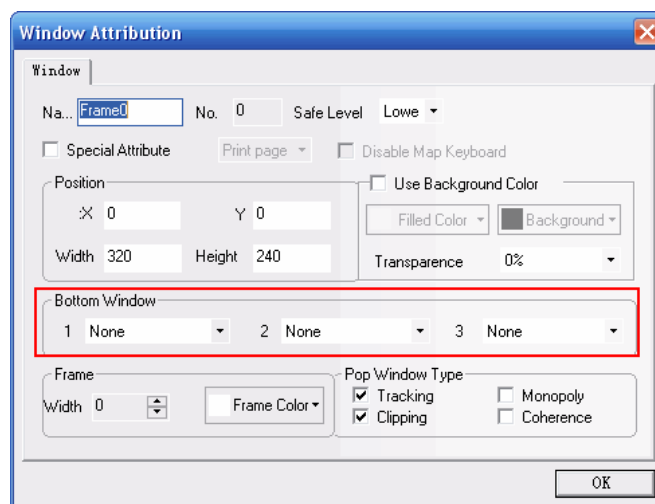

As shown in the figure above, you can select a bottom-layer window for the window in the **Bottom Window** option. A bottom-layer window is different from a common window. During runtime, the components of the bottom window are inserted into the general window, but actually this bottom window is not displayed. The display and control of components of the bottom window are the same as that of the general window. The bottom window is something like “transparent” for the panel users, The users operate the parts on the bottom window while they think they are touching the parts on the general window above the bottom window.

Relationship between screen and window: A screen can include: a common window, a base window and a fast selection window, while each common window or base window can include multiple pop-up windows. Their relationship is shown as follows:

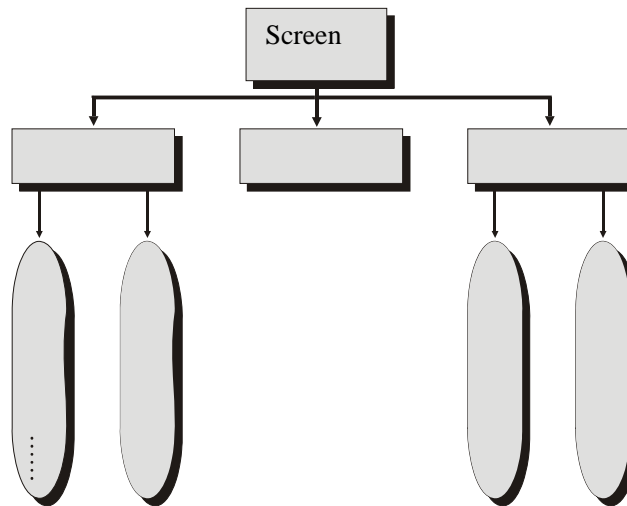

When the window switchover command is executed, the panel screen will clear all the current windows (including the pop-up windows attached to the current basic window), and switch over to the window to be displayed. However, the common window will always be displayed on the screen. A pop-up window invoked by a direct or indirect window will not change the original contents of the base window, and it is only attached to the base window. In the window property setting dialog box, each window can be configured with a maximum of three bottom windows.

When a base window is invoked (the window number ranges from 0 to 3~ 65535), the touch panel will show all parts in the window. In the meantime, if the window has a bottom window and all parts in the bottom window will be displayed also. All the touchable parts (such as bit state setting, function keys and so on) defined in the bottom window are also valid in the current window. The common window is also displayed with all parts of it valid if it has been invoked by taskbar button.

The maximum number of windows in a project is 65535 (including all three types of windows). A project can only have one fast selection window, however, the function key **Change Fast Selection Window** can be used to switch over to another window and assign that one to be the current fast selection window. For details, please refer to Section 6.29, "Function Key".

After creating a new blank project, it has a default start window. Normally this window is numbered "0" (to change the number, please change it in the **HMI Properties** dialog box in the project edit window). In general, a project contains multiple windows. The valid window number ranges from 0 to 65535.

By default, Window 1 and Window 2 are the common window and fast selection window of a project respectively. To change the default fast selection window and common window, double click the HMI to modify the **Touch Screen Extended Properties**, as shown in the following figure:

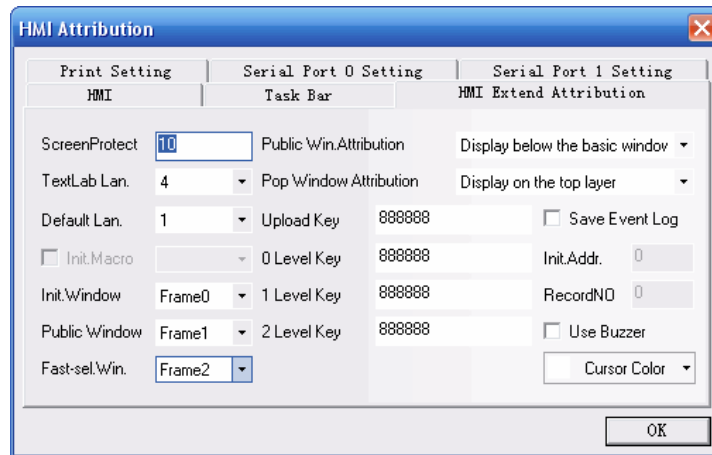
**Note:**

1. A maximum of 16 pop-up windows can be opened at the same time.
2. A window can only be opened once.
3. The function key **Close Window** cannot close direct or indirect windows, since the opening or closing of a direct window is only related to the ON or OFF state of the bit address that controls its switch, and the opening or closing of an indirect window is only related to the data content of the word address of the indirect window. The function key **Close Window** cannot change the values of these bit (word) addresses, so it cannot close these windows.
4. All pop-up windows are attached to the current basic window, so when the basic window closes (or switches to other basic window), the attached pop-up windows will be closed either. In this case, if you switch the window to the basic window previously opened again, you may find that the original pop-up windows attached to this basic window still exist (unless you run related command to close them).
5. The basic window must be of the full-screen size.
6. The fast selection window supports pop-up windows, but the “Truncated” feature of the pop-up windows invoked by fast selection window can not be selected when setting the property of that pop-up window.
7. Pop-up windows are attached to the windows which contain the parts that invoke those pop-ups. So pop-up windows invoked by parts in the common window will exist until the common window parts turn them off.

4.2 Window Properties

To set the window properties, double click on the blank area of the window or click the  icon to show the window properties setting dialog box.

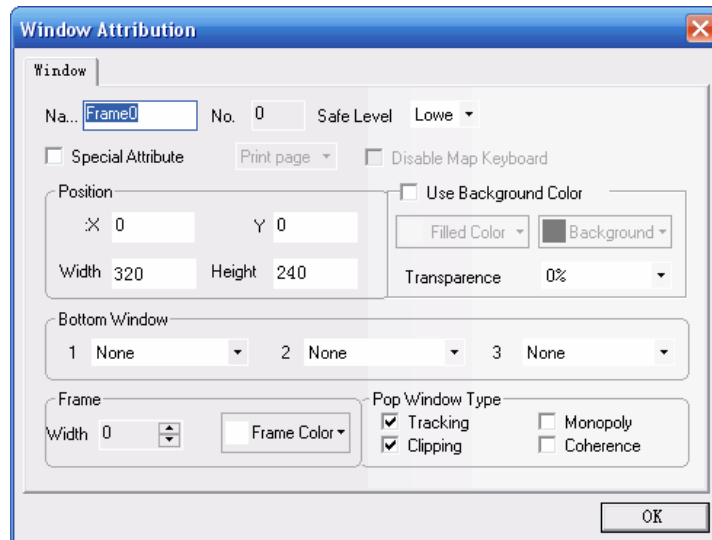

The descriptions of the window properties are as follows:

Name: A unique name allocated to each window for the convenience of differentiation and remembering. The name here can be changed whenever it is necessary to do so.

Number: The valid window number ranges from 0 to 65535. The window number is automatically allocated by the system when a window is created. The user cannot change it. The window numbers may not be consecutive due to the deleting/adding operations.

Position: If a window is a window that appears by use of the function key in **Pop-up Window**, the position of the point at the upper left corner of the window will be displayed here. The position of the origin of the screen is (0,0) and the origin point is the upper left corner of the screen.

Width/Height: A pop-up window supports the setting of width and height (smaller than the size of the screen, of course). However, a basic window should be set to the default size (that is, the full-screen size).

Print Page: Indicate whether the window is used as the print window. For more information about printing, refer to chapter 10.

Video Page: Indicate whether to set the window as a video window. (Only the MT5600T and MT5700T have the video function)

Use Background Fill Effect: To fill the background of window with the patterns or colors, check this option.

Fill Color and Background Color: Select according to the fill style used (for the description of the fill effect toolbar, please refer to Chapter 3). The selected fill color is the impression color, and the background color is the fill pattern color. Fill style 0 is used by default, that is, a pure color. In this case, only the fill color is displayed.

Pop-up Window Type: Track, Monopoly, Truncate and Coherence.

These parameter types indicate the relationship between a pop-up window and its adjacent window. If a window has the property of “Monopoly”, before the window appears, its father window

will be frozen, and furthermore, the pop-up window will be displayed in the topmost layer all the time. If a window has the property of “Truncate”, the frame of the window is restricted by its father window, that is to say, the part displayed outside the frame of its father window will be truncated. If a window has the property of “Track”, the window will track the movement of its father window.



Note: If “Truncate” is selected, “Track” must be selected either.

Window A and Window B in the following are attached to the base window. Normally, if you touch Window A, it will be displayed in the topmost layer. However, if the property of **[Coherence]** is selected for Window A, even if you touch Window A, it will not appear in the topmost layer. Instead, it clings to its father window all the time.



Note: After a window is created, its number cannot be changed, but the name, frame and background color can be changed whenever it is necessary.

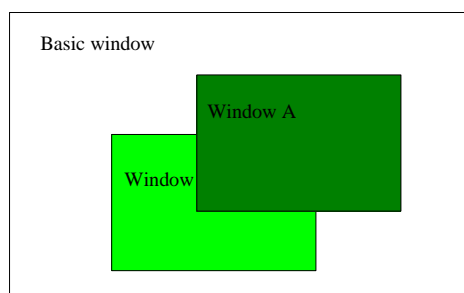
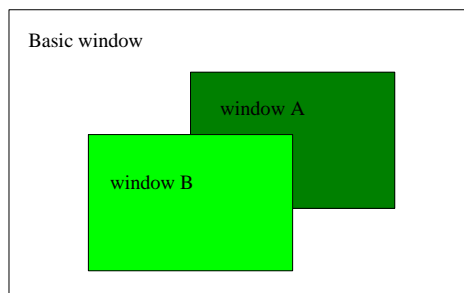

Security Level: Used to set the security level for a window. For details, refer to Chapter 12, “Security Level”.

Bottom-layer Window: Used to set the bottom window for the current window. A window to be assigned as a bottom window must be an existing one. In general, components shared by multiple windows can be placed here.

Frame: The frame is recommended to use for a pop-up window. For the frame width, select any number among 0 through 16. If the frame width is not “0”, select other color for the frame.

There are two ways for changing the window properties:

1. Double click the blank area in the window.
2. Do not select any component in the window. Click the  icon on the toolbar.



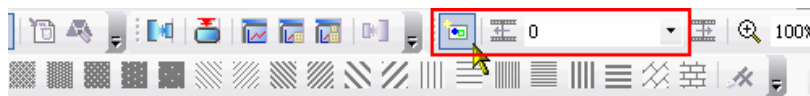

4.3 Creating a Window

Click  in the **[Window Toolbar]** to create a new window.



4.4 Opening a Window

After a window is created, make selection in the dropdown menu in the **Window Toolbar**, all existing windows can be selected from the list. You may also click the  icon to display the previous window. Click the  icon to display the next window. If you use a mouse with a wheel, you can directly roll the wheel to change the window number.



4.5 Deleting a Window

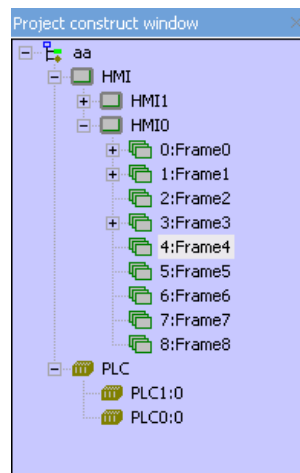

As shown in the above figure, in the **Project Construct Window**, select a window to be deleted, and press the **[Delete]** key in your keypad. In this case, an alert box appears. Select **[Yes]** to delete the window, all the components in the window will also be deleted. Be careful when using this function.

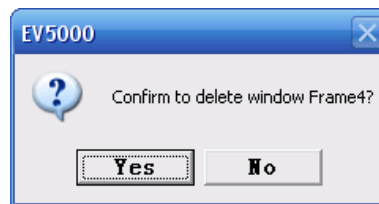

Note: The deletion of base windows (Frames 0, 1, 2 and 3) are forbidden. Once they are deleted, the project should not be downloaded into panel, or the panel will not operate normally..

4.6 Examples for Windows

Several basic examples will be given below to explain some basic operations about “window”.

◆ **Example 1:** We often need to write a special value into some registers as soon as a project starts running or an application window is opened, to conduct initialization. For example, when Frame0 starts up, LB0 is set to “ON”, and LW1 is set to “200”.

1. Create a bit setting part, with the **Address Type** set to LB, **Address** to "0", and the **Type** to **Set to ON at window open**.

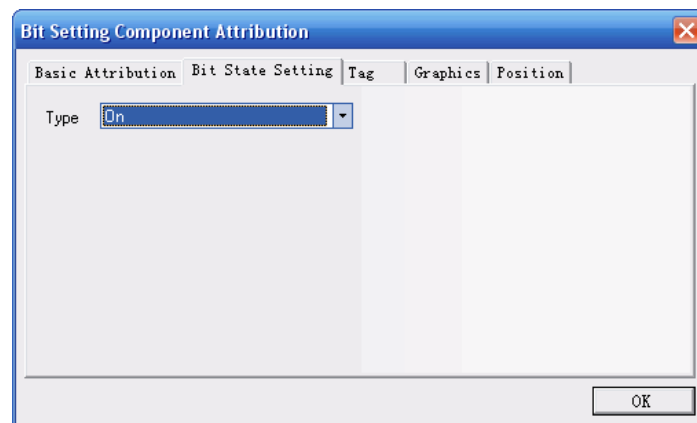
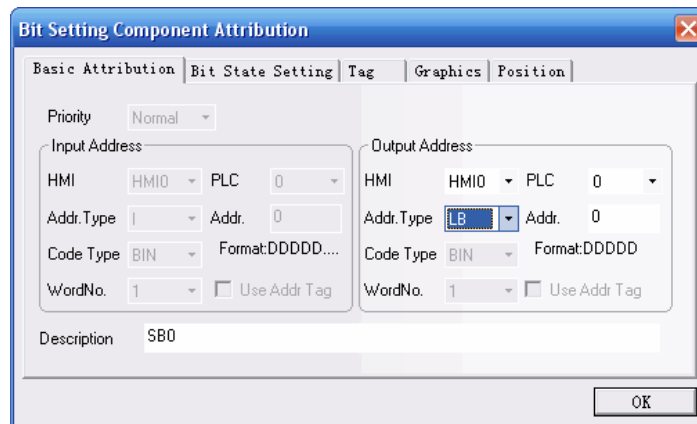

2. Create a multi-state setting component, with the **Address Type** set to LW, **Address** to “1”, **Type** to **Set to ON at window open**, and **Set Value** to “200”.

The screenshot shows the 'Word Setting Component Attribution' dialog box with the 'Multi-State Setting' tab selected. The 'Input Address' section is configured with HMI: HM10, PLC: 0, Addr. Type: LW, and Addr.: 0. The 'Output Address' section is configured with HMI: HM10, PLC: 0, Addr. Type: LW, and Addr.: 1. Both sections have Code Type: BIN and Format: DDDDD. The 'WordNo.' is set to 1. The 'Description' field contains 'SWD0'. The 'Priority' is set to 'Normal'. An 'OK' button is visible at the bottom right.

The screenshot shows the 'Word Setting Component Attribution' dialog box with the 'Multi-State Setting' tab selected. The 'SettingMode' dropdown menu is set to 'Set at Window Open' and is highlighted with a red box. The 'Set Value' text box contains the value '200' and is also highlighted with a red box. An 'OK' button is visible at the bottom right.

3. Create a Indicator lamp part, with the **Address Type** set to LB, and the **Address** to "0", to display the state of bit register LB0.

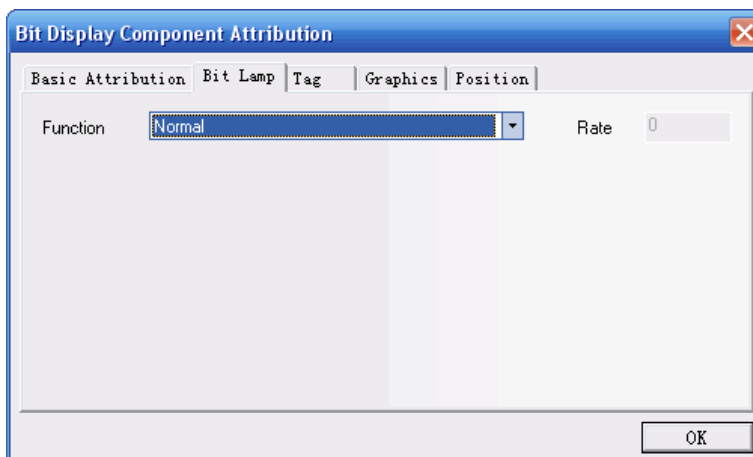
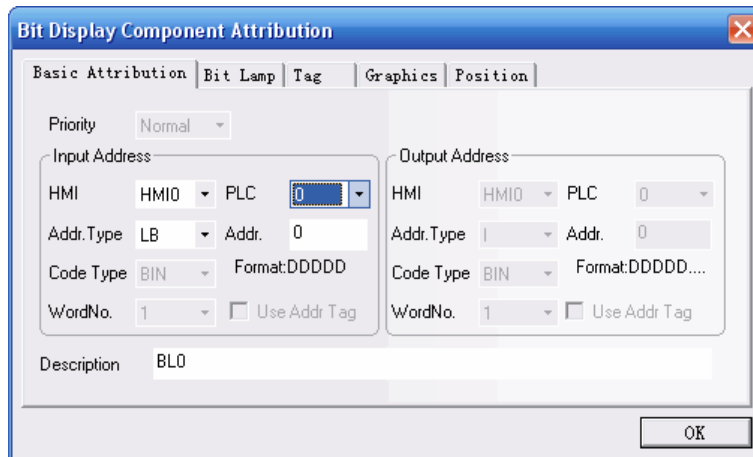

4. Create a number display part, with the **Address Type** set to LW, and the **Address** to "1", to display the state of LW1.

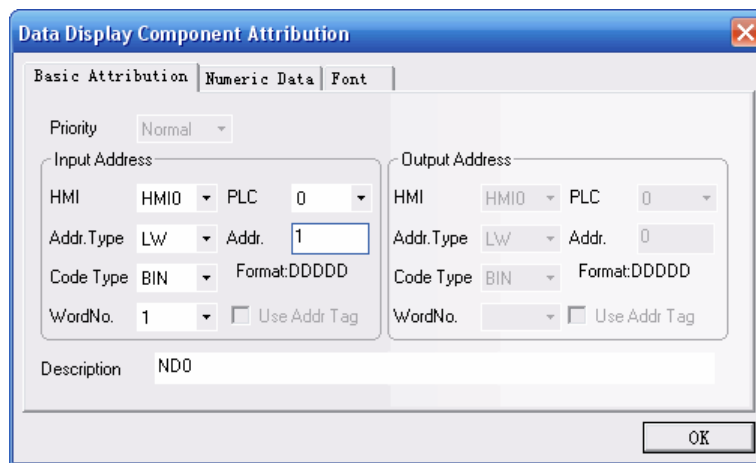

5. The finished project window is shown as follows:

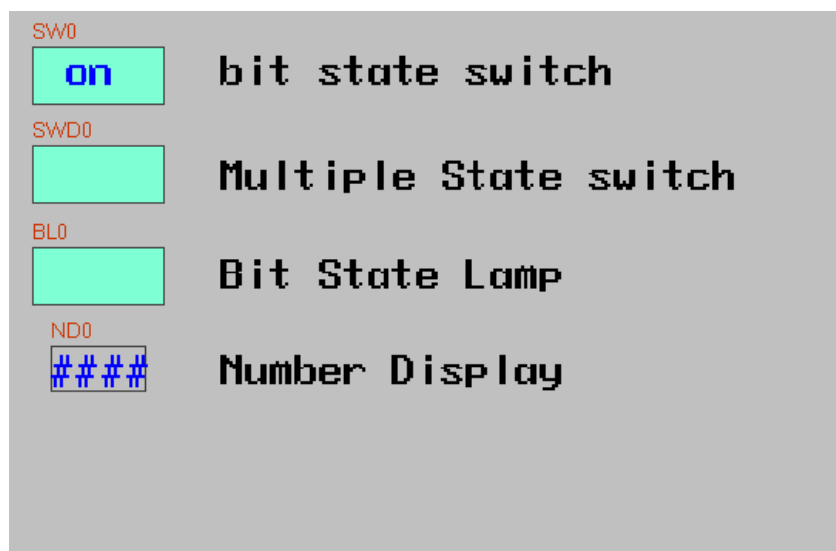

6. Save, compile and perform online simulation of the project: LB0 is set to ON, and LW1 is set to 200.

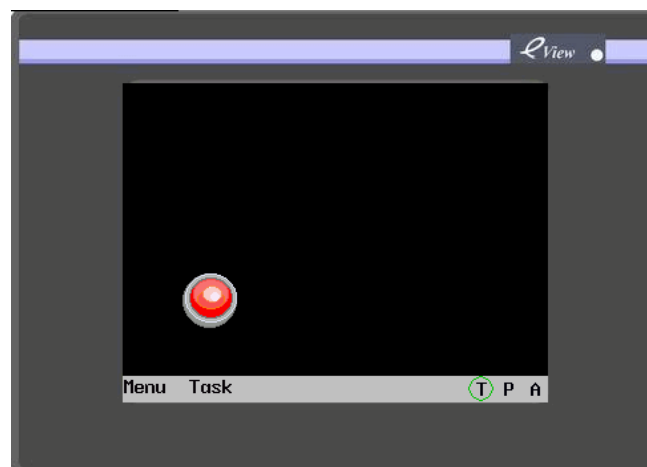
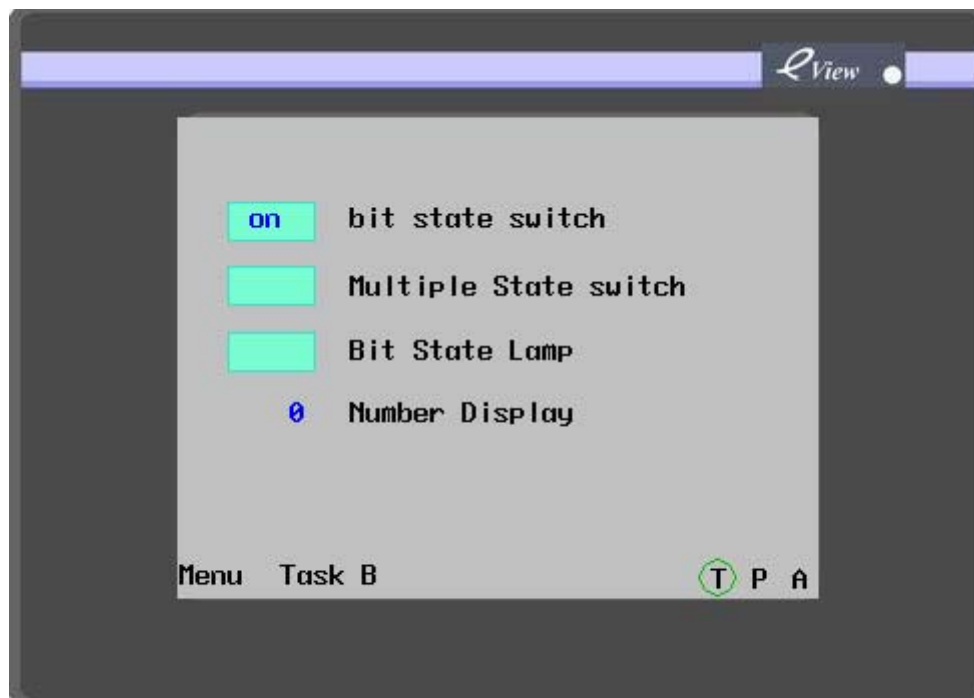

Reference for this example: Section 6.1, “Indicator Lamp”, Section 6.2, “Bit Setting Component”, Section 6.4, “Multi-State Setting” and Section 6.11, “Numeric Display” in Chapter 6.

◆**Example 2:** It is an example of pop-up keypad window for number entry. In many cases, we need to conduct write operation for registers. If the keypad is fixed on the current window, it will occupy too much screen area, so that the current window design space of the project is greatly reduced. In this example, we use the direct pop-up window method to solve this problem. Assume that LW0 is the register need an input operation.



Note: The EV5000 software has a keypad in Window 3, which can be directly invoked, so you do not have to create a keypad by yourself each time. To create your own keypad, please refer to chapter 6.

1. Create a new project or open an existing one. Enter the window editing mode. Create a numeric input component, with the **Address Type** set to LW, **Address** to "0", **Address Type** in the **Trigger Address** tab set to "LB", and **Address** in the **Trigger Address** tab set to "9000". (by default)

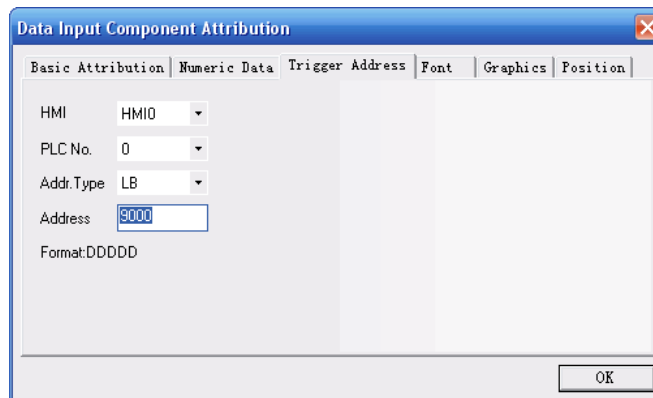
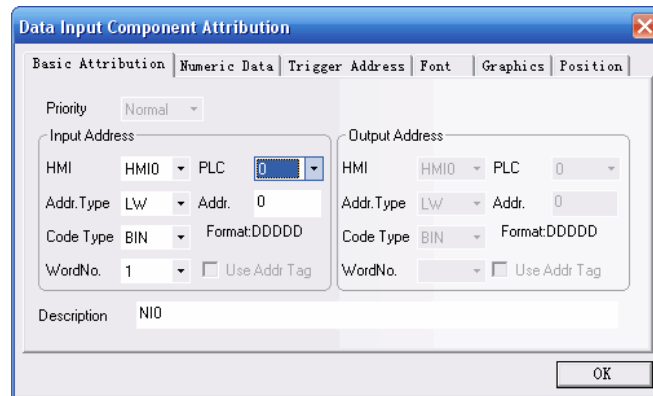

2. Window 3 is built into the blank project wizard so after creating a new project, user can find window 3 in the project construct window, double click the icon of frame 3 will open it: set the Width to 145, Height to 190. The Window Properties dialog box is shown in the following figure:

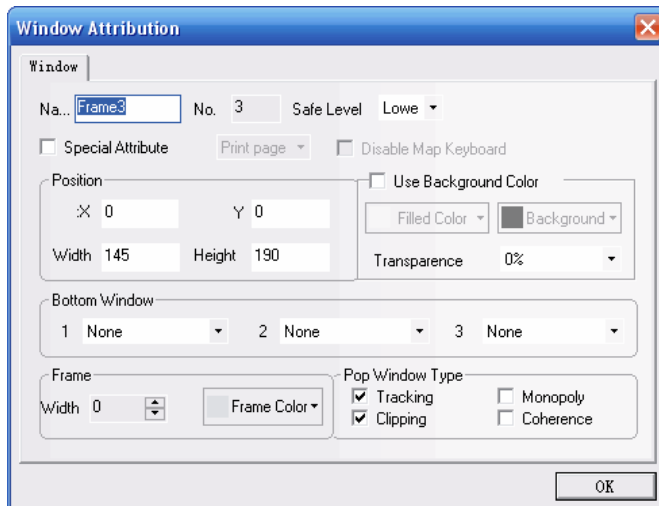

edit the window 3, put a number input keyboard in the center of the window.



3. Create a direct window part, with the **Address Type** set to “LB”, **Address** to 9069, and **(Window No.)** to “3”. Adjust the width and height of the component to be of the same size as Window 3.

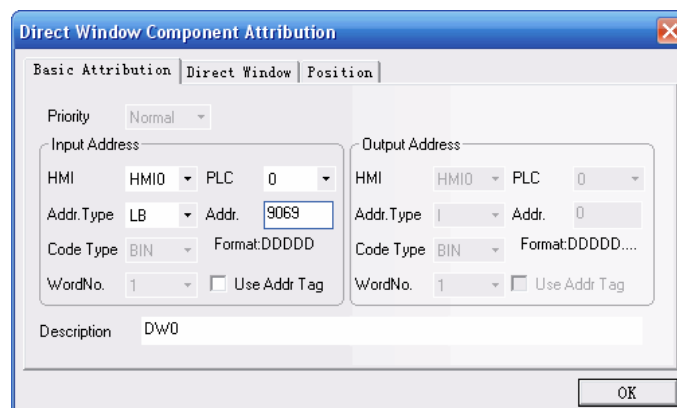

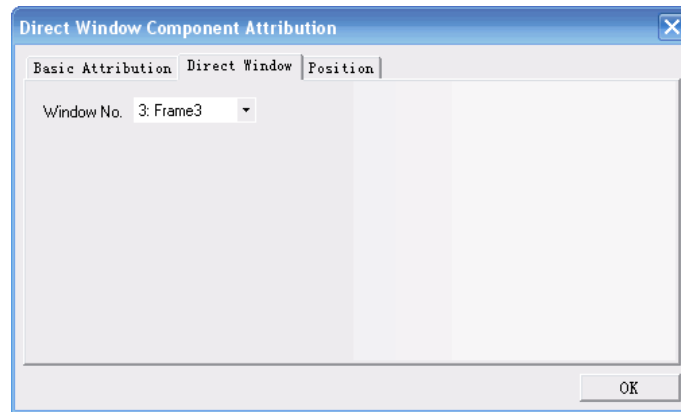

The entire project is shown as follows:

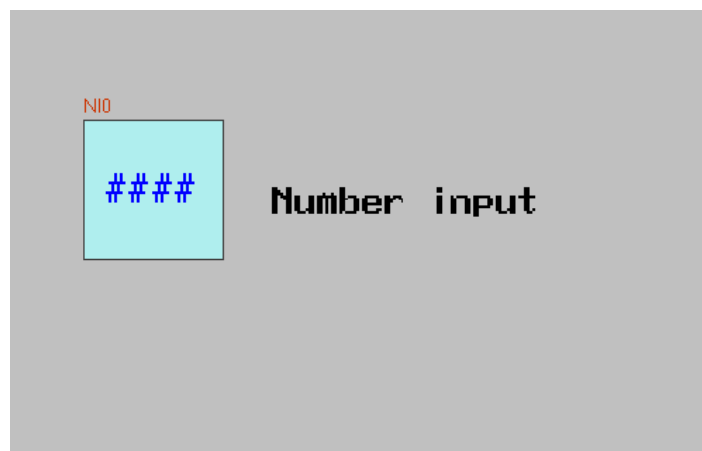

Save, compile, and make offline simulation of the project:

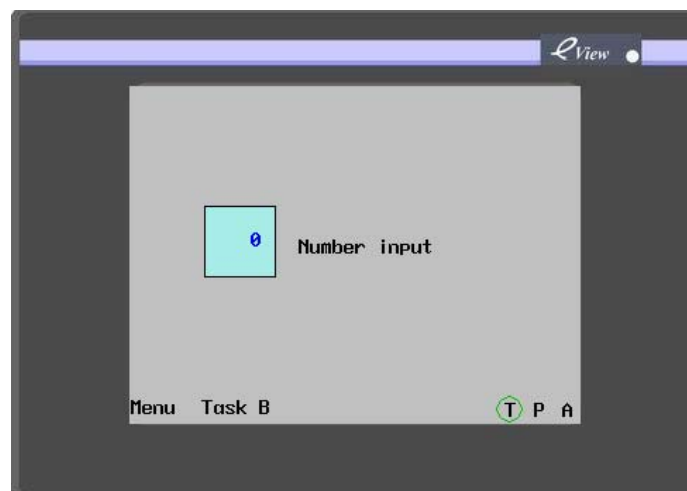

4. Click **Number Input part**. Upon LW0 input, a keypad appears below the component for you to input. After the input, the keypad automatically disappears, as shown in the following figure:

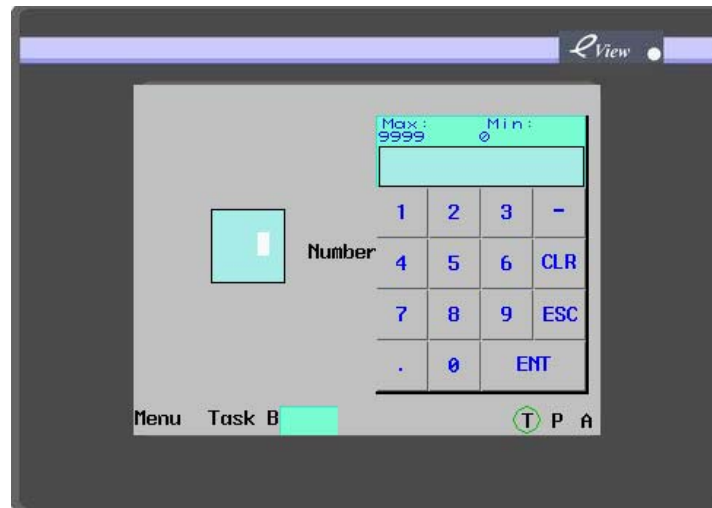

4.7 Window-related Components

Function keys directly related to windows include: **Change Basic Window**, **Return to Previous Window**, **Change Common Window**, **Pop-up Window** and **Change Fast Selection Window**. Components directly related to windows include: Direct windows and indirect windows. For the contents of these components, refer to related contents in Chapter 6, "**Components**".

Chapter 5 Design with EV5000, Some Basic Knowledge

5.1 Parts

Generally, a window contains many parts of different kinds, such as switches, lamps, numeric input parts and shape parts. Parts are divided into two species: PLC parts and Function Parts. They can be found in the Graphic element Window. Following a three-step procedure, the user can add a part to the window.

► Process of adding a PLC part

1. Click to select then drag a part icon from the PLC component toolbox to the window editing area.
2. After dropping the icon, the **Component Attribution** dialog box of the part appears. Set the properties of the part in this dialog box. Attributions most frequently used are PLC input/output address, vectogram or bitmap, label, position, and so on.

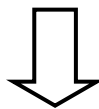

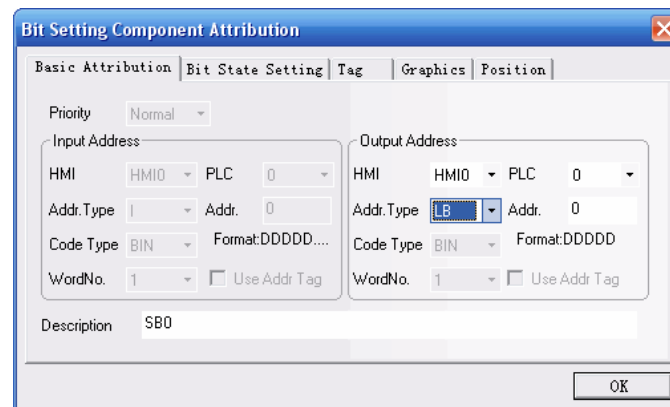

- After setting the various properties of the part close the dialog box, users can see the part appears in the window. Users can drag the icon to adjust the size and position of the part. For precise adjustment, open the part **Component Attribution** dialog box and input the value of size and position in the “**Position**” tab.

The procedure of adding a function part is similar with that of the PLC part,

5.2 About Part ID

- ID is a number automatically allocated to a part. It is used to differentiate parts on the screen. The designer cannot manually designate or change the component ID. The ID has two parts: a combination of two or three letters indicates the full name or function of that part and a number used as a symbol to distinguish the part from its homogeneous. All the letter combinations and their meanings are listed below:



BL: Indicator lamp

WL: Word Lamp (Multi-State Display)

SB: Bit setting component

SWD: Word setting

SW: Switch

MSW: Multi-state switch

FK: Function key

MV: Moving Parts

ANI: Animation

NI: Numeric Input

ND: Numeric Display

TI: Text Input
 TD: Text Display
 BR: Bar graph
 SC: Scale
 IDW: Indirect Window
 DW: Direct Window
 AD: Alarm Display
 TR: Trend Curve
 RCP: Recipe data transmission
 ED: Event Display
 TM: Timer
 OS: Oscilloscope
 SCR: Scroll bar
 BG: Bitmap graph
 VG: Vector graph
 XY: XY Plot
 MT: Meter
 AB: Alarm Bar
 NP: Note Pad

5.3 Additional Note (Description)

If necessary, each component can be added with a note. This note only plays the function as a descriptive remark for the current program, and can serve as future reference, which facilitates in the understanding of print results. This note does not have any substantial influence upon the program.

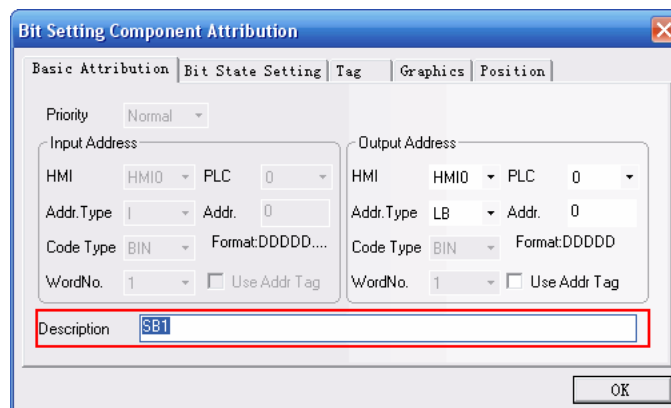

5.4 Input/Output Address of PLC

Parts related to PLC registers during runtime must be designated with proper PLC I/O address to

ensure the program run correctly. The correct address type and range are different for different PLCs. As shown in the following figure, PLC0 is a MODBUS device, while PLC1 is a SIEMENS product, so their addresses are different. The program will automatically list the correct address type and range according to the PLC type.

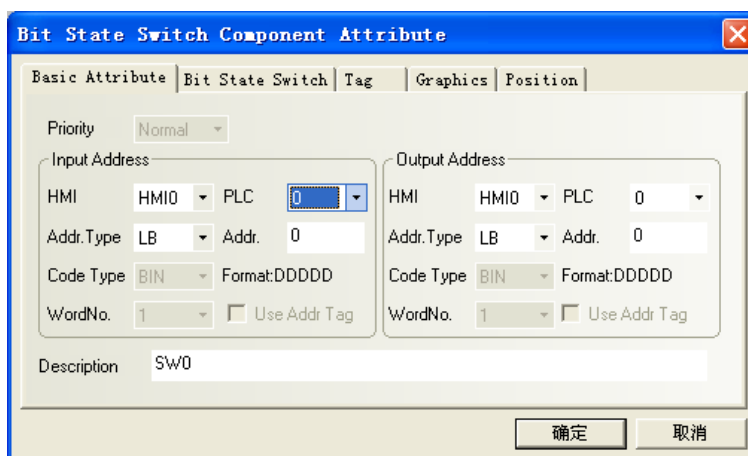

The PLC list box can display the numbers of all available PLC devices.

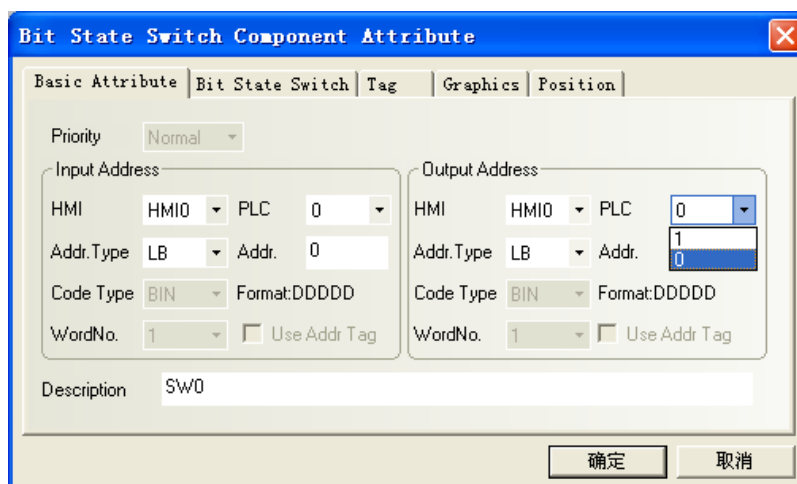

An internal node can also be selected as input origin or output target. The descriptions of the internal nodes are as follows:

Type	Device Name	Range	Description
Bit	LB	0~9999	The register is in the local memory
Bit	RBI	0.0~261000.15	Index address of the recipe memory , in X.Y format,
Bit	RB	0.0~261000.15	h=0~F, absolute address of the recipe memory
Word	LW	0~10256	Address of the Local memory
Word	RWI	0~261000	Index address of the recipe memory
Word	RW	0~261000	Absolute address of the recipe memory

RB and **RW** point to the same area, for example, **RB5.0~RB5.F** and **RW5** map into the same word

of the recipe memory, **RB5.0** is **Bit0** of **RW5**. However, **LB** and **LW** map into different areas, and their addresses in the memory are different.

LB9000~LB9999 in **LB** and **LW9000~LW10256** in **LW** are reserved for system functions, which have special usage, so the user cannot use them like common nodes. Therefore, the user should use their special functions according to related instructions. For details, please refer to Chapter 11. If an index address accesses the recipe memory, the index address itself serves as the base address, the offset address is stored in the register LW9000, the physical address is the sum of the base address and the offset. For example, if **(LW9000)= 50**, the index address **RWI 100** will access the data of the addresses of **RW 150 (100+50)**. (For details, refer to Chapter 8, “**Recipe Data**”.)

5.5 Vector graph

Shapes and images are organized in libraries in ev5000 software. There are two kinds of image: Vector Graph and Bitmap. Library of vector graph is named as *.vg file and bitmap library is named as *.bg file. The user can create vector graph with the drawing tools in ev5000 drawing toolbar. Vector graphs are suitable for simple shapes like buttons, lamps, and pipes and so on. Each *.vg or *.bg file has up to 32 states and 32 different appearance, so the user can use one single graph to represent a multi-state variable or part. *.vg and *.bg files are stored in the **Shape Library** in the **Project File Window**, as shown in the following figure:

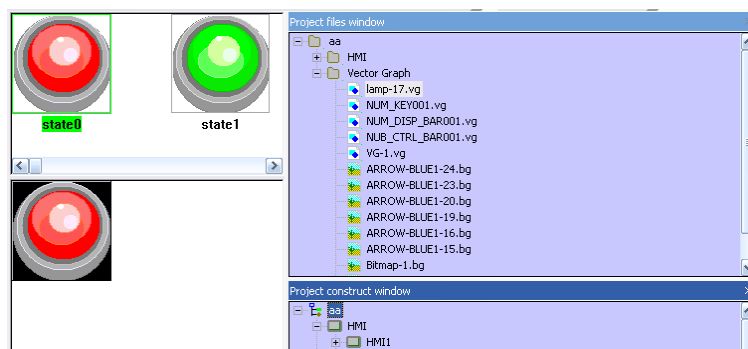

Some shape library files are installed into the ev5000 folder with the program files, the user can import these pre-made shape into their own projects. Click the  **Import Shape Library** icon on the toolbar, and the following dialog box appears:

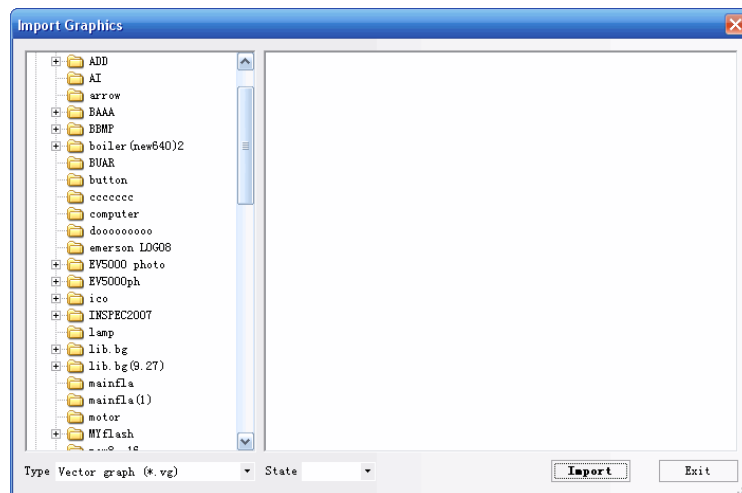

Then, find the LIB/vg file under the software installation directory, the .vg files are classified into different categories stored in corresponding folders for easy browsing. Select a vectogram to be imported, click **Import**, the vectogram will be copied to the vg folder under the current project directory. It supports the simultaneous import of multiple vectograms or bitmaps. For shapes in the same folder, you only need to select all shapes to be imported, and click **Import**. All the vectograms and bitmaps imported or created for the entire project will be displayed in the **Shape Library** in the **Project File Window**, so that the user can view and use the shapes conveniently.

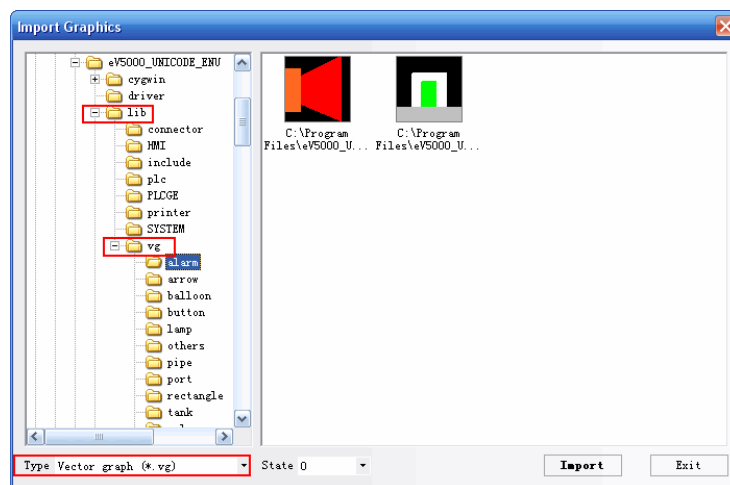

A vectogram may include 32 states, and it can be use in two modes: static vectogram without changing states or indicator of a multi-state part.

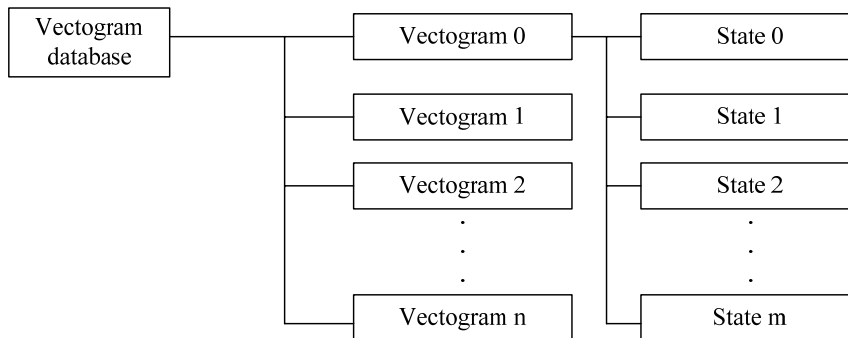

► Procedure of creating a new vector graph

1. Select **New Graphics** in the **Library Menu**, or click the  icon on the toolbar, the following dialog box appears.

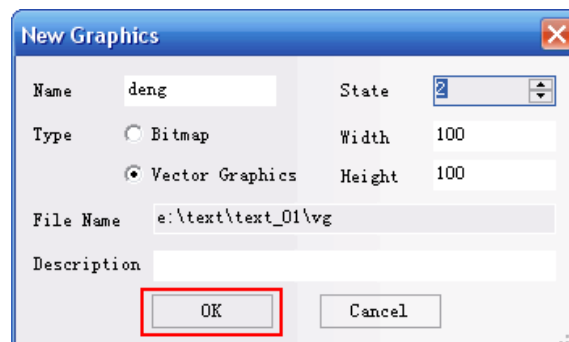
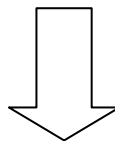
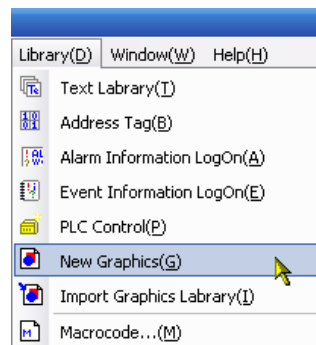

2. Name the vector graph, select “Vector Graphics” and enter the number of state that vector graphic has. The size of the graphic and the filename can be designated here, too. For better understanding, the user can add a description to the graphic as a note. In this example, it is named as “Lamp” with two states. Click **Create**, and the following editing window appears:

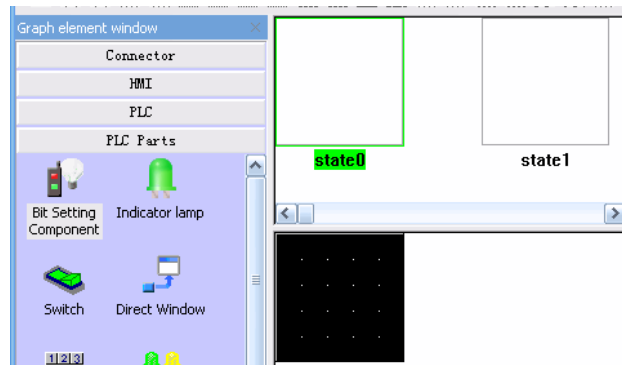

The user can add more states to the vector graphics after creating them. The procedure is described here:

Double click the *.vg you want to add states to to enter the drawing window, Click the icon  to add a new state to the current vg. A vg can have up to 32 different states.

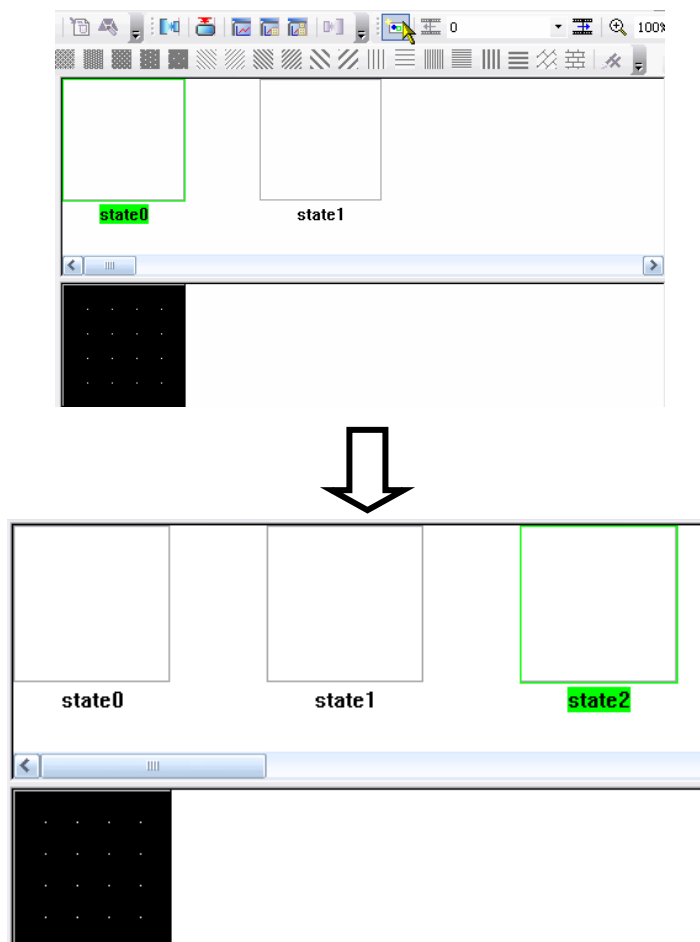

3. Click to select a state, the state being selected is outlined by a green frame. By default, the latest added state is set to be selected after being added. Draw lines, rectangles and other shapes with the tools in the drawing toolbar to edit the appearance for the selected state. After finishing drawing for all states, click save and close the drawing window.

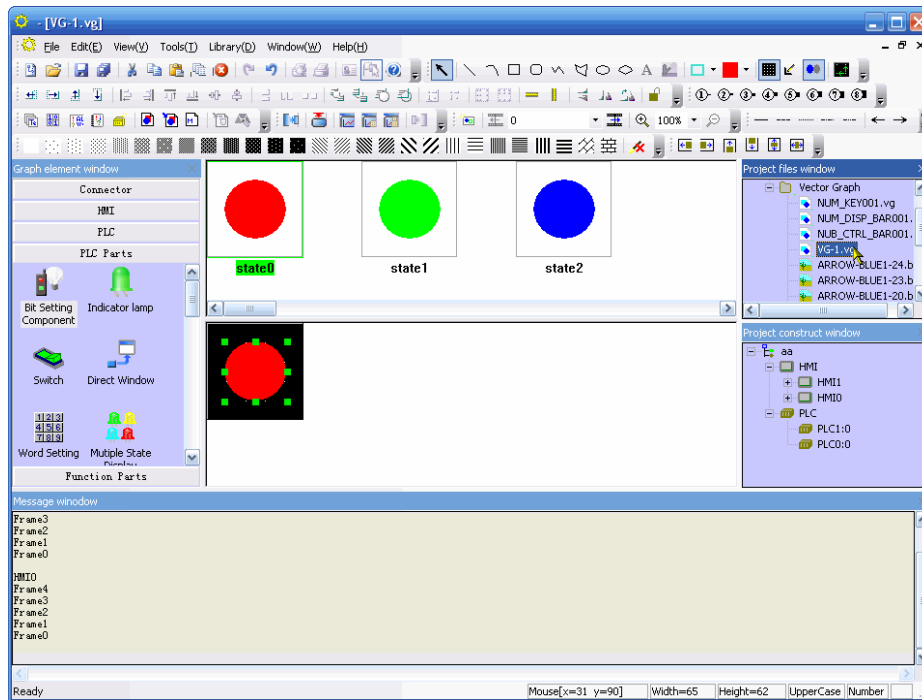

- Return to the configuration window, select a component and open the component attribution dialog box of it :as shown in the following figure:

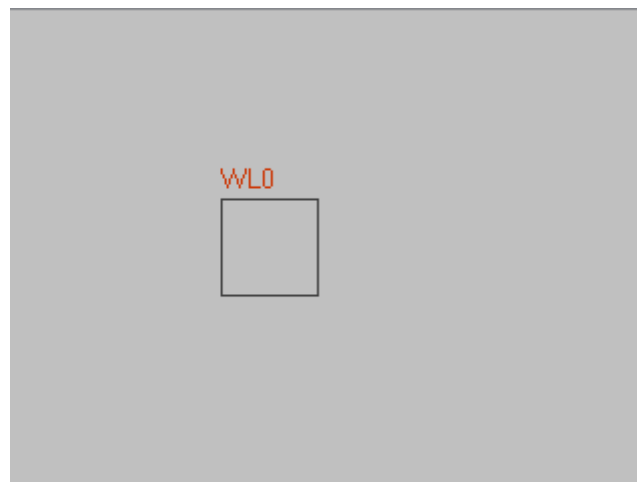

- Switch to the Shape tab in the dialog box, check the selecting box “use vector graphic” and select the vector graph for the part in the list below. All vg files imported into the project can be found in the list. In this example, select the vg you have just created.

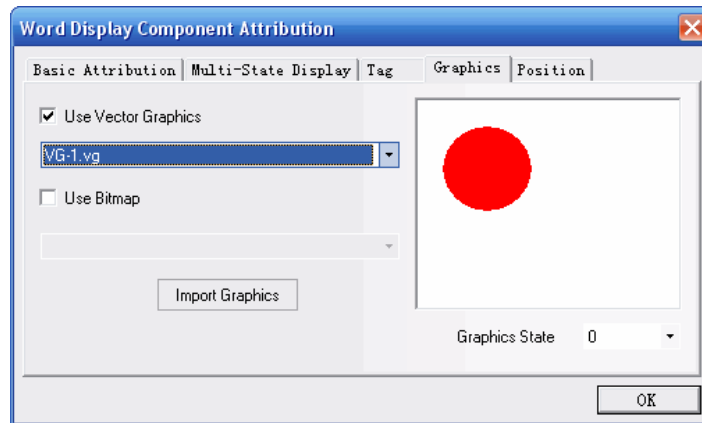

6. Close this dialog box, and the component will be displayed in the screen in the mode of a vectogram.

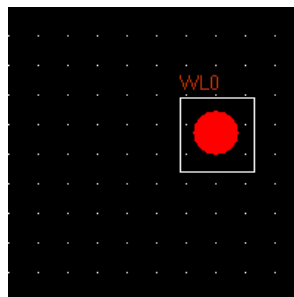

All loaded *.vg files will be listed in the **Project File Window**, under the directory of **Shape Library**.

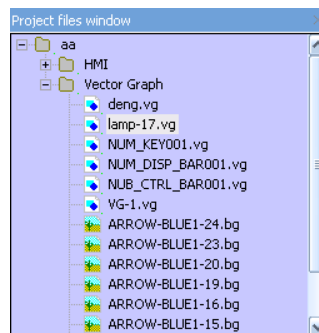

To modify any vectogram or bitmap, find the shape to be modified in the **(Project File Window)**, double click to enter the edit window of the shape, and you may modify the shape in this window. The above line shows the various states of the vg or bg file, and the area below the states window is the appearance editing area for the state being selected.

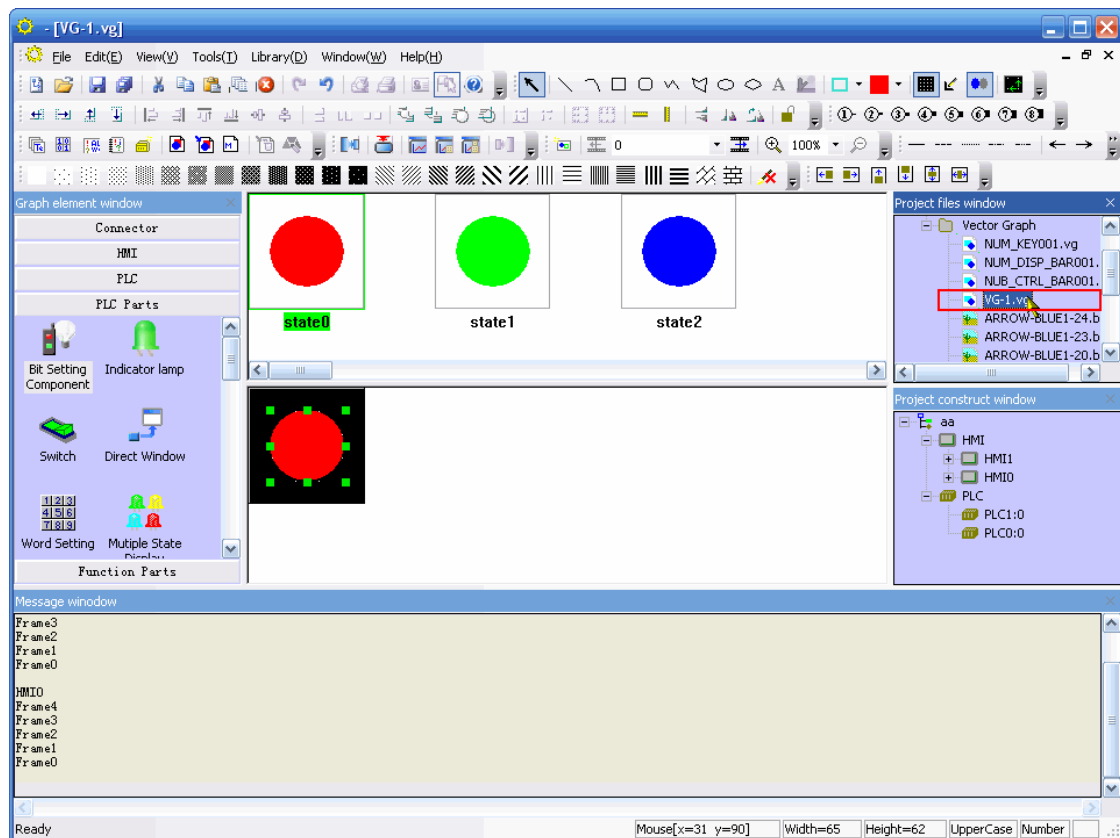
**Note:**

1. After creating and editing a vg shape, click save before close the editing window, or you will lose all the changes you've just made.
2. No text can be added to a vectogram.

5.6 Bitmap Graphics

Like vector graphic, a bitmap graphic can also have up to 32 states and represent different states of a multi-state part with a single graphic. The most significant difference between bitmap and vector graphic is that the user can import external images of various formats (*.bmp, *.jpg and *.gif) into the project and converted them to *.bg files. The basic operations of a .bg file are quite similar to those of a .vg file, with a few differences.



Note: Such operations as drawing a line and drawing are forbidden in a bitmap. Only external shapes can be added.

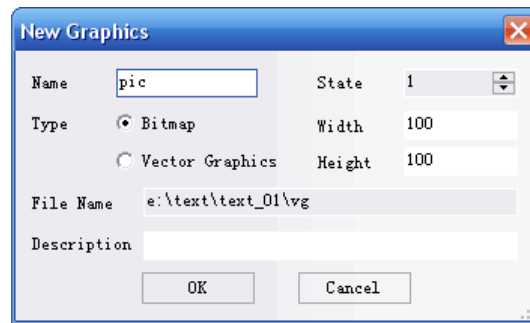

The procedure of creating and editing a .bg file is shown below:

1. Select **New Graphics** in the **Library** menu or click the  icon on the toolbar, the following dialog box appears:

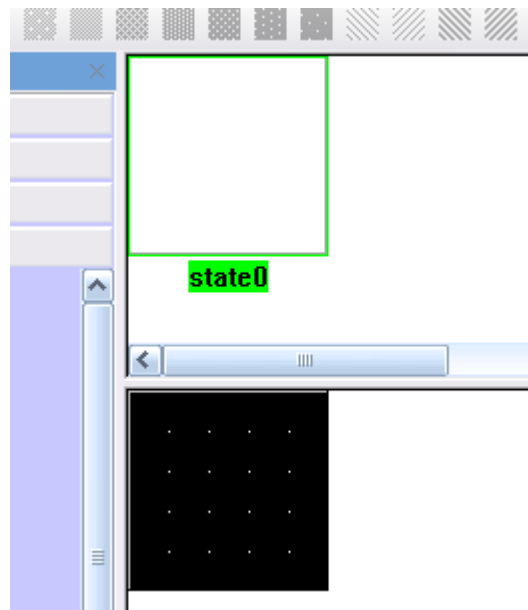

2. Select **Bitmap** for **Type**, enter the number of states and name of the bg, click **Create**.



The user can add additional states to an existing .bg file. The procedure is described as follows: Double click the bg file you want to add state to in the Project File Window. After entering the editing mode, click the editing area below the states preview window, the  icon for adding new states will be activated. Click the  icon, a new state will appear after the current last state in the states preview window. The latest added state will be selected and ready for editing.

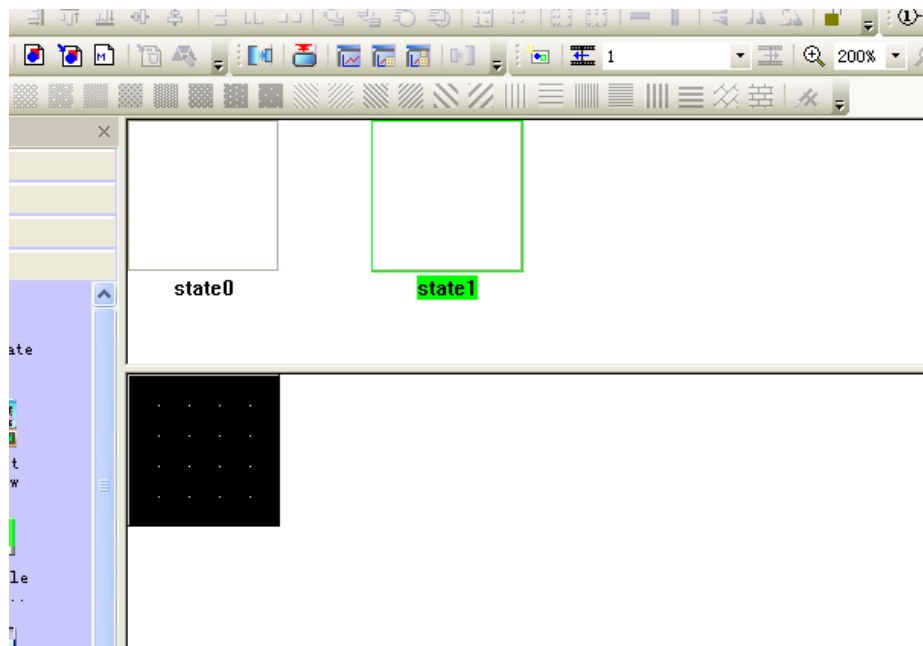
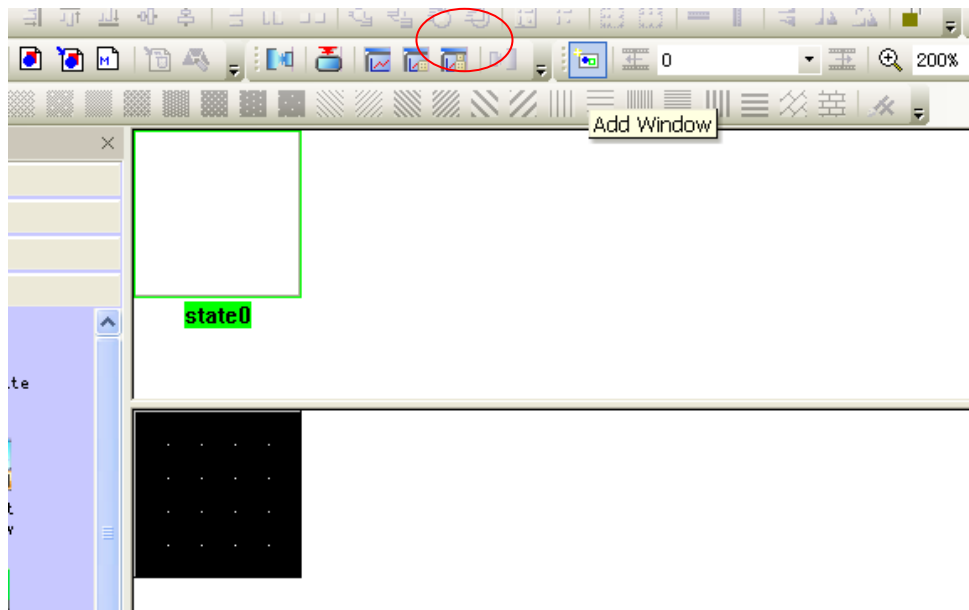

3. Click the  icon in the **Drawing Toolbar**, find the image you want to import, click to open it. For bitmap graphics, you can only import a picture, other editing operations such as line drawing tools and other similar tools are disabled, as shown in the following figures:

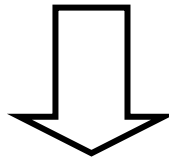

- Click **Save** and close the bitmap editing window, you can use it in the configuration window through the bitmap component.

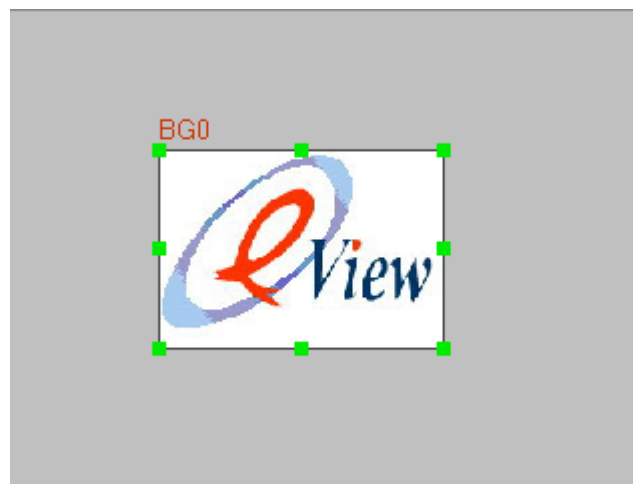
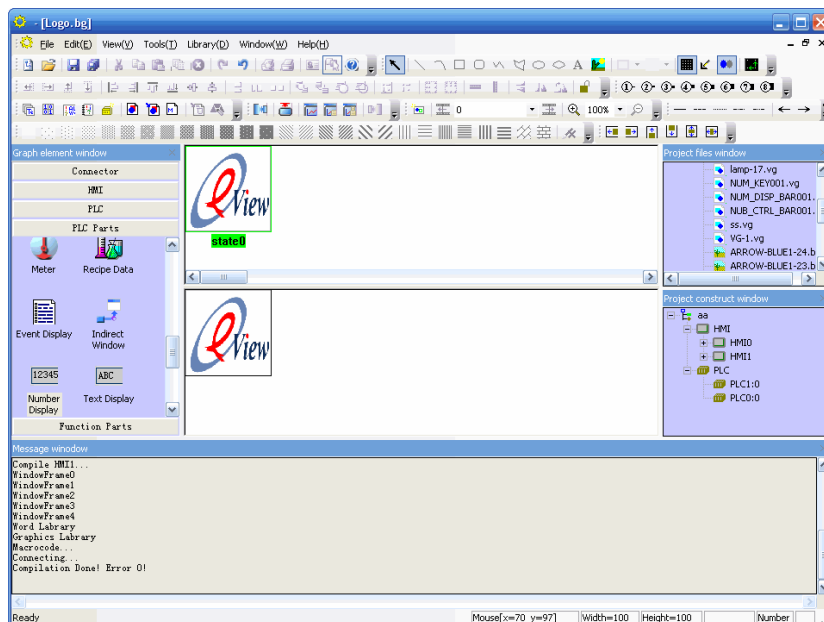

Use of bitmaps:

- Select a component you want it to use a bitmap, open the component attribution dialog box and switch to the Shape tab:

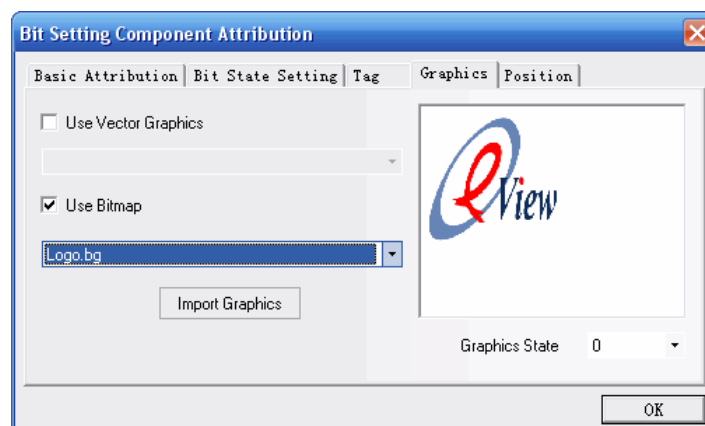

2. Select the **(Use Bitmap)** option. Select the bg file to be used, the preview of the bg is shown on the right. Click **(OK)** to close the dialog box.

Import Existing Bitmap Graphics:

1. You may import a bg file like the import of a vg file. Click the  icon to show the importing dialogbox. Select **Bitmap** for the **Import Type**. You can import *.bg files used in other projects (they are stored in the “vg” folder under the directory of the project folder.) or *.bg files provided by us. (visit our website to download the bg file package,)

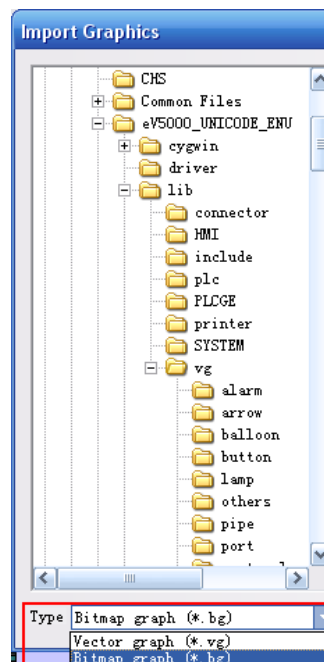

2. The *.bg files and *.vg files of the same project are stored in the “vg” folder under the project folder directory. The *.bg file is converted from other images; the original images are stored in the “image” folder under the project folder directory. Please do not delete the images in that folder, or the corresponding *.bg files will not be used any more.



Note:

The original image is stored in the “image” folder when being imported, so the image must have a unique file name to avoid conflict. If such conflict occurs when editing a new .bg file, the newer image will not be added to the “image” folder, so the two bg file, including the previous and the new one, will be linked to the same original image and they may look the same.

The size and color quality of images in the bitmap library determine the size of the target file, and also affect the configuration execution speed. Please pay attention to the following points when a bitmap library is created:

- i. The maximum size for original image being imported is the physical resolution of the panel. Any image exceeds this size cannot be imported. In this case, the image should be cut into the proper size before being imported. It is strongly recommended to resize the original image to the same size of the part using that image. Doing so will greatly save storage space and

ensure the fast run of the panel. For example, the user want to import an image for a part of the size 100×60, but the size of the original image is 200×120, Since the image size doesn't exceed the smallest panel resolution 320×240, the image can be imported and used for that part, but it will be displayed as a 100×60 part, which means the a original image of the size 100×60 will have the same effect. Resize the larger original image will certainly save 3/4 storage space and small file will save the time for the panel CPU. Always take your time to resize the image to proper size will make the project file smaller and run faster.

- ii. Images are stored in lossless compression mode in the panel, so any image of the loss compression format (for example .jpg) will be converted to lossless compression file, which may make the file larger than original image. The actual size of an image depends mainly on the number of pixels. For example, for a 100×60 color picture, its size before compression is 100×60×2 (=12000 bytes), and the compression rate in lossless compression mode is 10~80%, depending on the specific images. Therefore, to reduce the project size, reasonable optimization of the image size and colors is the best way.
- iii. When importing a bitmap, if there is no special requirement, try to make the outer frame of the bitmap fit the outline of the edit box; otherwise, a blank area will appear in the bitmap. Suppose the user import a 100×50 original image to a edit box of the size 100×100, the user should stretch the image after importing to make it fill the edit box. When using the bitmap graphic in configuration window, you can stretch the outline of the part or enter the size in the "Position" tab of the component attribution dialogbox, In these two method, you can retrim the bitmap to its correct ratio. (image needed)

5.7 Creating a Label

A label refers to a text displayed on the surface of switches, lamps or other components.



► Adding a label

1. Select **Label** tab in the Component Attribution Dialogbox of the part selected.
2. Check the option **Use Label**.
3. As shown in the following figure, fill the content to be displayed on the label in **Content**.

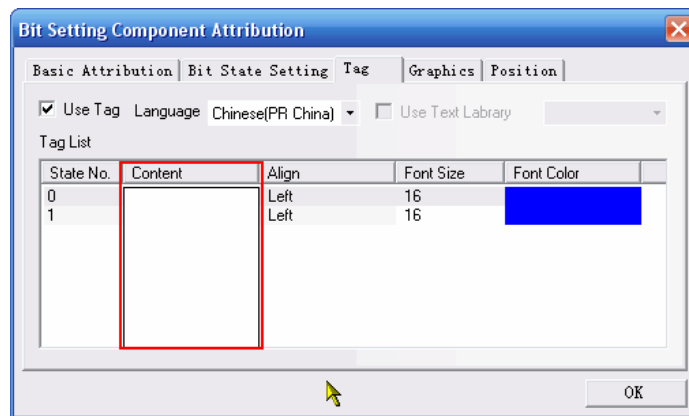

4. Set such display properties as alignment mode, font size and color.
5. Click **OK** to finish the setting.

State No.: The **State No.** is only valid for components with multiple states. The text of each state can be displayed independently. The user can set the text content, font size, color and the alignment for corresponding states separately.

Content: Enter the text to be displayed on the surface of the component. If there are multiple lines, press the [Enter] key to start a new line.

Font Size: The variable font size range is: 8, 16, 24, 32, 48, 64, 72 and 96 pixels.

Alignment: If the text input of a label exceeds two lines, **Left**, **Right** or **Center** can be selected for the alignment of the multiple lines.

Color: The user can select from a palette of 40 frequently-used colors among 65536 colors. The **Primary Color** palette includes the most frequently used colors. The **Custom** palette allows the user to customize a palette (there are 65536 optional colors).



5.8 Taskbar and Task Buttons

The eView5000 provides a simple method for window actions such as pop up or minimize, change the display or quickly switchover between windows. All these can be done with taskbar.

The taskbar provides two task buttons, one is used to control the Fast Selection window, and the other is used to control the taskbar itself.

In the **HMI Attribution** dialogbox in the project window (double click the HMI icon or right click and select “Attribution” to open it), the user can set the taskbar, including whether to use the Fast Selection window, color, position, and other related properties. (By default, all the items in the taskbar are selected)

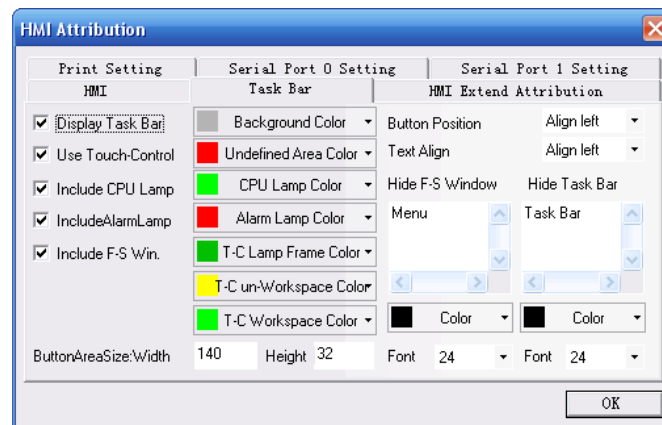

If **Include Fast Selection Window** (labeled as “Include F-S Window”) is selected, click the Fast Selection window button in the left, a Fast Selection window appears. This window provides some function keys (placed by the user) for switching to different windows. Since the Fast Selection window is always displayed in all screens, it can be invoked anytime. To switch to a specific window, touch the function key pointing to the destination window, in this way the process of monotonous window search can be avoided.

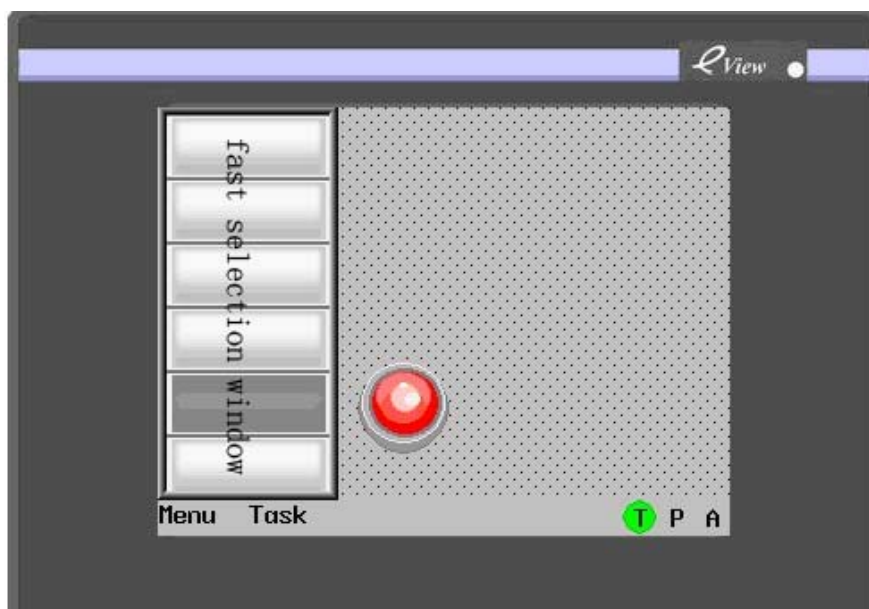

The taskbar can include a maximum of 16 window icons at the same time. Double click the **Minimize** icon, and the related pop-up window will be minimized; clicking this icon again will retrieve the minimized window to original state. Pop-up window with the function keys **Minimize Window** and **Window Bar** can be minimized to the taskbar. Refer to the description in the **Components** and **Function keys** part in Chapter 6.

► Procedure of setting task buttons

In the project window, double click HMI to show the HMI Attribution setting dialog box. Open the Taskbar tab, check the **Display Taskbar** option. The user can set the position of the task buttons: to the right or to the left. The label content of the taskbuttons can be changed in the corresponding edit box. Background color and alignment of the text can be set in the dialogbox also. If the labels of the two task buttons can not be fully displayed, try to adjust the button area size and the font size of the text.

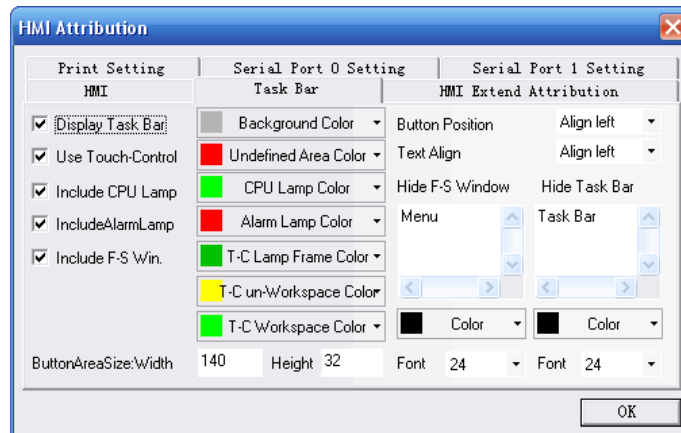

Note: During operation, the Fast Selection window is displayed in the left or right of the screen. In the edit window state, the Fast Selection window is an independent window. Window 2 serves as the Fast Selection window by default. For detailed descriptions of the taskbar, please refer to Section 7.2.

Chapter 6 Components(Parts)

Components(Parts) are designed to meet specific requirements. In general, a component is designed to implement one function. However, some components have to be used with other components and objects or a PLC to implement specific functions, as shown in the table below:

Component	Related Component/Object	Description
Numeric input	Function key	Keypad created by "Function key"
Text input	Function key	Keypad created by "Function key"
Indirect window	Window	"Indirect window" part must point to an existing window
Direct window	Window	"Direct window" part must point to an existing window
Alarm information logon	Alarm display Alarm banner	Alarm information displayed on the screen or the banner must be entered in the system by using the "alarm information logon" function
Alarm display	Alarm information logon	Alarm information displayed on the screen or the banner must be entered in the system by using the "alarm information logon" function
Alarm banner	Alarm information logon	Alarm information displayed on the screen or the banner must be entered in the system by using the "alarm information logon" function
Event information logon	Event display	Event information must be entered by using the "Event information logon" tool before it can be displayed.
Event display	Event information logon	Event information must be entered by using the "Event information logon" tool before it can be displayed.
PLC control	PLC	Function defined by "PLC control" part is invoked or controlled by PLC registers

Most components support "bit" or "word" addresses (such components as numeric input and scroll bar can perform double word operation). Since some PLCs have "double word" address, so the drivers of these PLCs will convert between "double word" address used in the PLC and "word" address used in the panel. The user has to pay special attention to the operation instructions for PLC drivers.

6.1 Indicator Lamp



An indicator lamp displays the ON or OFF status of a designated PLC bit address. If the bit status is OFF, the shape representing state 0 will be displayed. If the bit status is ON, the shape representing state 1 will be displayed. The corresponding label will also be displayed if “Use Label” is enabled. The figure below shows the appearance of an indicator lamp component.

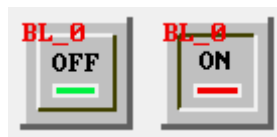

► Adding an indicator lamp

1. Click the **Indicator Lamp** icon and drag it to the configuration edit window, the component attribution dialogbox shows, the first tab is the **Basic Attribution**:

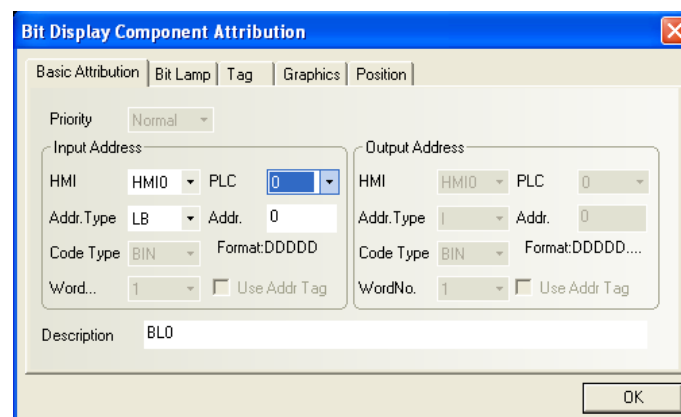

- **Priority:** Reserved function, not used for the time being.
- **Input Address:** Bit address of the PLC register that controls the lamp state, shape and label information.

HMI: If your project contains more than one HMI panel, select which HMI panel the lamp part belongs to in this field.

[PLC]: Select a PLC. If this HMI is connected with more than one PLC, select the PLC containing the expected register.

Address Type: Select the address type corresponding to the lamp, that is, the address type of the register being monitored. The address type varies with PLC type. Besides the PLC registers, you can also use the bit registers within the HMI panel. For internal register address of HMI, refer to Section 5.4. Please note that some internal addresses of the HMI are reserved by the system. Do not use these system-reserved addresses. For details,

refer to Chapter 11.

Address: Bit address corresponding to the lamp.

Use Address Label: Whether to use the address entered in the address label. For details, refer to Section 6.34.

Description: A reference name (not displayed) that you assign to the lamp.

- Go to the **Lamp** tab:

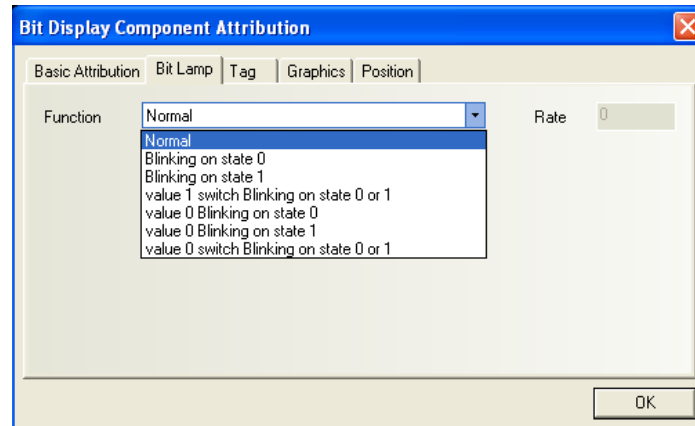

➤ **Function:**

Normal: Just display state graphic in static state.

Blinking on state 0: The lamp will Blink the shape corresponding to state “0” when the bit status is OFF. The blinking period is set in the **Rate** text box. When the bit status is ON, the lamp will show the state 1 shape in static state.

Blinking on state 1: The lamp will Blink the shape corresponding to state “1” when the bit status is ON. The blinking period is set in the **Rate** text box. When the bit status is ON, the lamp will show the state 0 shape in static state.

- Go to the **Label** tab: Fill in text to denote OFF or ON state. :

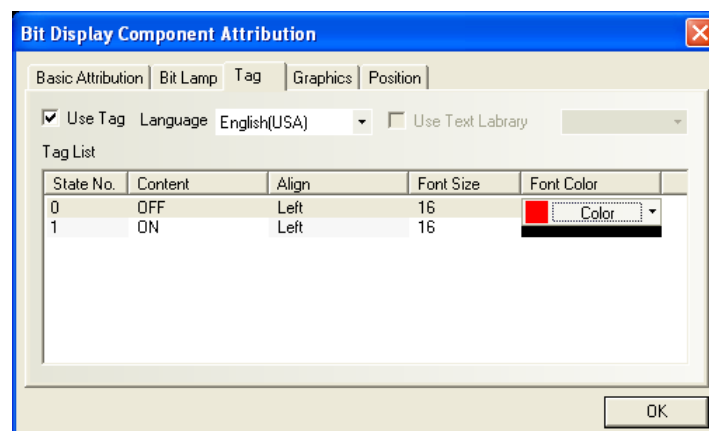

State: in this example as the above figure shows, the label for the lamp state 0 is “OFF” and turns to “ON” when the lamp state is 1. The user can enter any content for the specific state.

Alignment: Three alignment modes are available:

Left: Entered contents are placed to the left edge of the graphic

Right: Entered contents are placed to the right edge of the graphic

Center: Entered contents are placed in the middle of the graphic

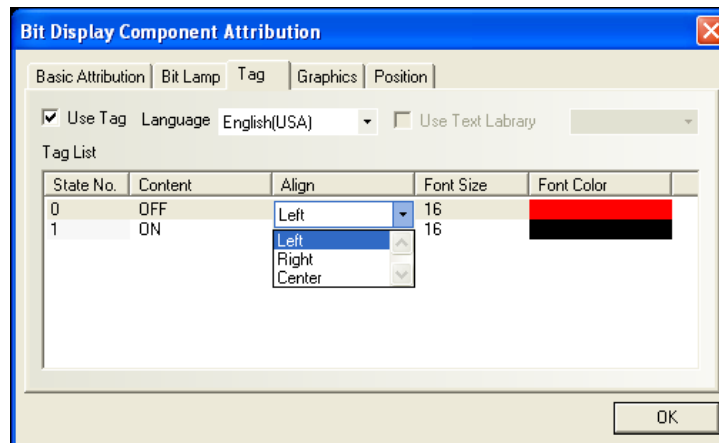

Font Size: Select the font size for the entered label text, including such options as 8, 16, 24, 32, 48, 64, 72 and 96, as shown in the following figure:

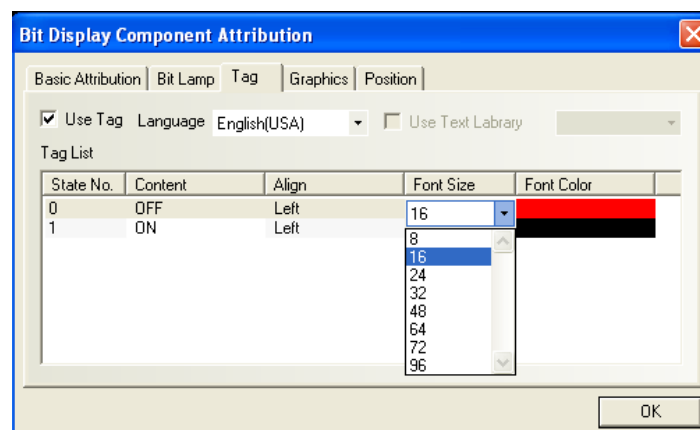

Color: Select the color of the label contents. The available colors are shown in the following figure. Besides the color listed here, the user can use “Custom...” option to customize a desirable color.

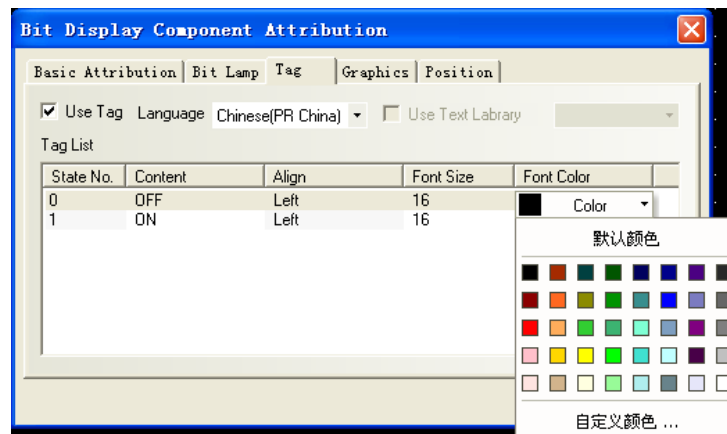

4. Go to the **Shape** tab: Select vectogram or bitmap to display bit address ON and OFF states.

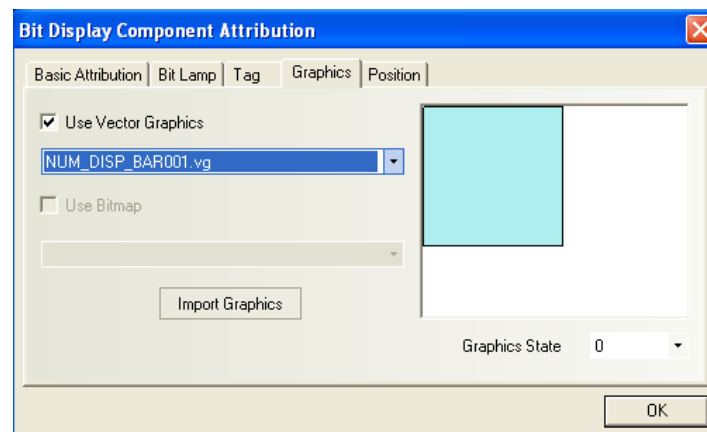

5. Go to the **Position** tab, adjust the position and size of the lamp if necessary.
6. Click the OK key to complete the setting of the lamp component.

6.2 Bit Setting Component



The bit setting component defines a touch area, which sets a specified bit to a certain status, ON or OFF, when it is touched or activated by other conditions.

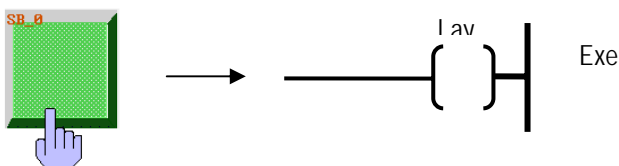

► Adding a bit setting component

1. Click the bit setting component icon and drag it to the window, the Component Attribution dialogbox appears. The first tab is the **Basic Attribution** tab.

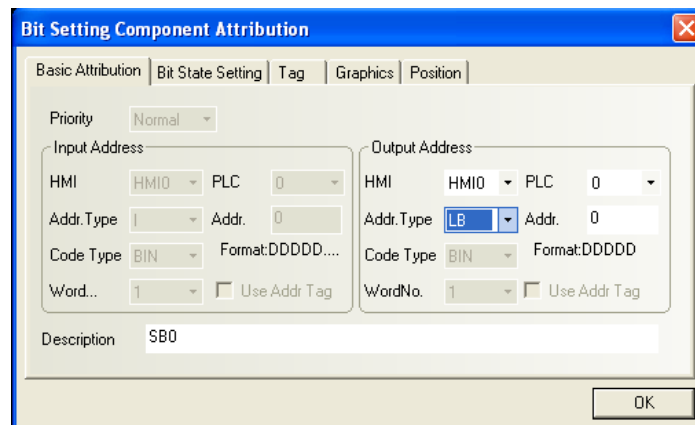

- **Output Address:** Bit address of the PLC register whose ON or OFF state is controlled by the bit setting component. The “HMI” field, “PLC field” and “Address type” field is similar with those of the Indicator lamp component.

Address: Bit address of the register corresponding to the bit setting component.

Use Address Tag: Whether to use the address stored in the **address tag library**. For details, refer to Section 6.34.

Description: A reference name (not displayed) that you assign to the bit setting component.

2. Go to the **Bit State Setting** tab:

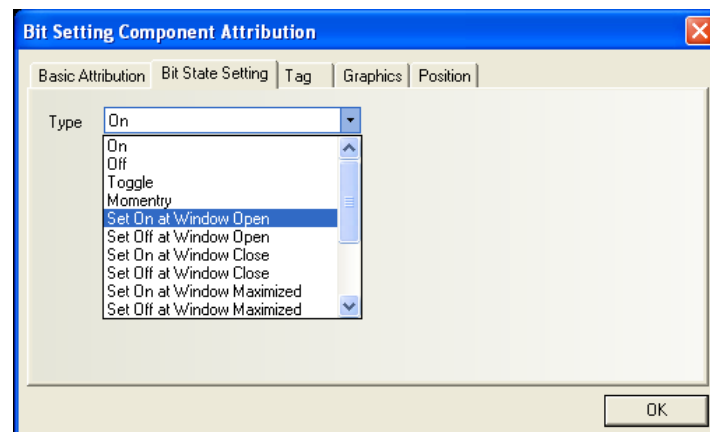

Several modes of the function of the bit setting component are listed here, as the following table describes.

Type and Functions of Bit Setting Components

Type	Description
ON	When the bit setting component is touched, the corresponding PLC bit register is turned ON. The state will be kept (i.e. remains ON) even after release.
OFF	When the bit setting component is touched, the corresponding PLC bit

	register is turned OFF. The state will be kept (i.e. remains OFF) even after release.
Toggle	Every time the bit setting component is pressed, the corresponding PLC bit register flip its current status once (ON → OFF, OFF → ON) (Toggles).
Reset	Only while the bit setting component is held down (pressed) will the corresponding PLC bit register be turned ON. Likewise, when the switch is released, the specified bit register is turned OFF.
Set ON at window open	When the window containing this bit setting component is opened, the corresponding PLC bit register is turned ON.
Set OFF at window open	When the window containing this bit setting component is opened, the corresponding PLC bit register is turned OFF.
Set ON at window close	When the window containing this bit setting component is closed, the corresponding PLC bit register is turned ON. This operation is only applicable for local bit (LB or LW.x).
Set OFF at window close	When the window containing this bit setting component is closed, the corresponding PLC bit register is turned OFF. This operation is only applicable for local bit (LB or LW.x).
Set ON at window Max.	When the window containing this bit setting component is maximized, the corresponding PLC bit register is turned ON.
Set OFF at window Max.	When the window containing this bit setting component is maximized, the corresponding PLC bit register is turned OFF.
Set ON at window Min.	When the window containing this bit setting component is minimized, the corresponding PLC bit register is turned ON.
Set OFF at window Min.	When the window containing this bit setting component is minimized, the corresponding PLC bit register is turned OFF.
Set ON while back light OFF	When the window containing this bit setting component is being displayed and the back light is OFF, the corresponding PLC bit register is turned ON.
Set OFF while back light OFF	When the window containing this bit setting component is being displayed and the back light is OFF, the corresponding PLC bit register is turned OFF.
Set ON at successful input	When a numeric input component has conducted a successful input operation in the window containing this bit setting component, the corresponding PLC bit register is turned ON.
Set OFF at successful input	When a numeric input component has conducted a successful input operation in the window containing this bit setting component, the corresponding PLC bit register is turned OFF.

3. Go to the **Tag** tab: Fill in text to denote states.
4. Go to the **Graphics** tab: Select a vectogram or bitmap to indicate the touch area and touch status (whether this component is pressed or not).
5. Go to the **Position** tab: and adjust the position and size of the bit setting component if

necessary.

5. Click **OK** to complete the setting of the bit setting component.

6.3 Switch



The switch is a combination of Indicator Lamp and Bit Setting components. It indicates the ON/OFF status of a PLC bit register, and defines a touch area, when activated, it may change the status of a designated bit register. The input address and the output address can be the same or different.

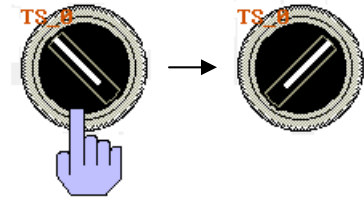

► Adding a switch component

1. Click the switch icon and drag it to the window, the **Basic Attribution** tab of the **Component Attribution** dialogbox appears.

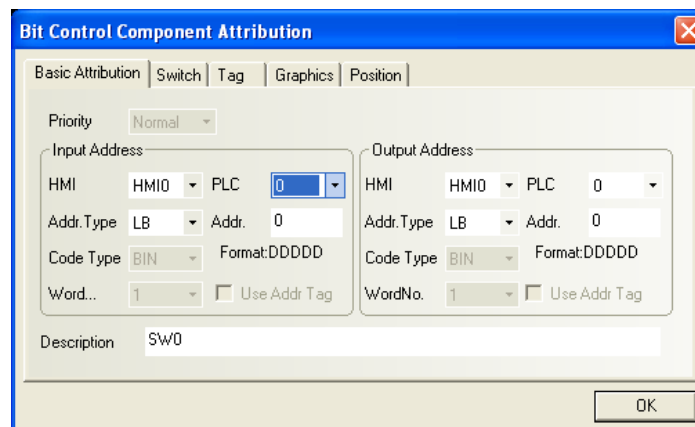

Priority: Reserved function, not used now.

- **Input Address:** Bit address of the PLC register that controls the switch state, shape and label information.
- **Output Address:** Bit address of the PLC register whose ON or OFF state is controlled by the switch.

Address: Input/output address of the register corresponding to the switch.

Use Address Tag: Whether to use the address entered in the address tag library. For details, refer to Section 6.34.

Description: A reference name (not displayed) that you assign to the switch component

2. Go to the **Switch** tab and set switch types:

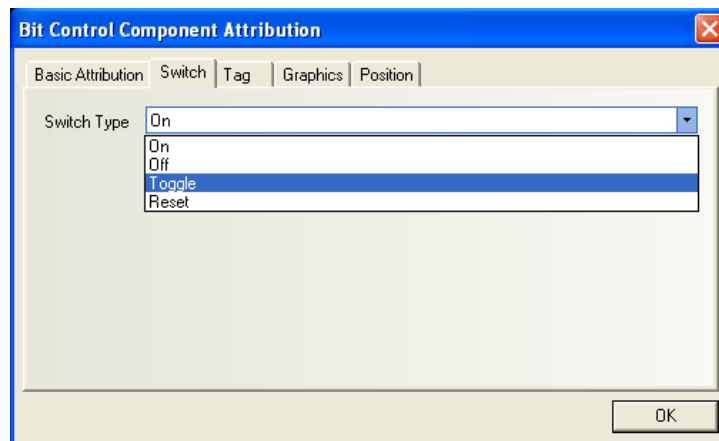

Switch Types and Functions

Type	Description
ON	When the component is pressed (touched on the panel), the corresponding PLC bit register is turned ON. The state will be kept (i.e. remains ON) even after being released.
OFF	When the component is pressed (touched on the panel), the corresponding PLC bit register is turned OFF. The state will be kept (i.e. remains OFF) even after being released.
Toggle	Every time the component is pressed, the corresponding PLC bit register flips its current state once (ON→OFF, OFF→ON)
Reset	Only while the component is held down (pressed), is the specified PLC bit register turned ON. Likewise, when the switch is released, the specified bit register is turned OFF.

3. Go to the **Tag** tab: Fill in text to denote states.
4. Go to the **Graphics** tab: Select a vectogram or bitmap to indicate the bit register states and represent the touch area.
5. Go to the **Position** tab, and adjust the position and size of the switch component if necessary.
6. Click **OK** key to complete the setting of the switch component.

6.4 Word Setting



The word setting component is also a touch area that when activated writes a word to the designated PLC word register.

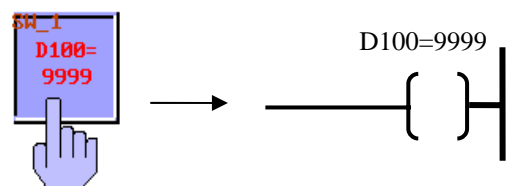

► Adding a word setting component

1. Click the word setting component icon in the **PLC parts** window and drag it to the **configuration edit** window, the **Basic Attributions** tab of the **Component Attribution** dialogbox appears.

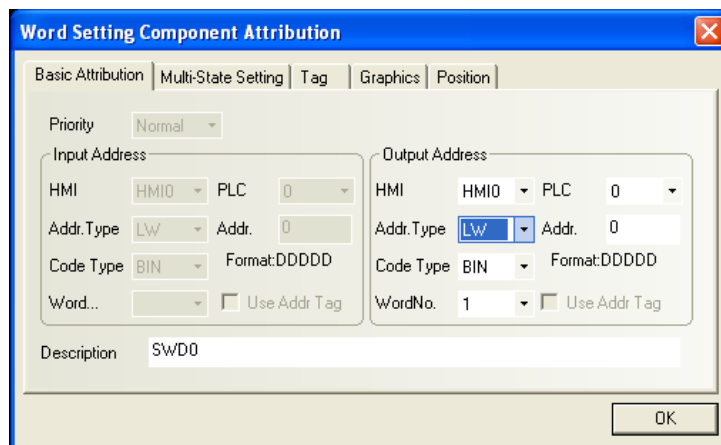

- **Output Address:** Address of the PLC word register controlled by the word setting component.
- Address Type:** The type of the word register, the prefix for word address varies with PLC type.
- Address:** The address of the PLC word register corresponding to the word setting component.
- Code Type:** BIN or BCD.
- No. of Words:** Select 1 or 2 for word output address (single word or double word).
- Use Address Tag:** Whether to use the address entered in the address tag library. For details, refer to Section 6.34.
- Description:** A reference name (not displayed) that you assign to the word setting component.

2. Go to the **Multi-State Setting** tab and select the setting modes for word setting component:

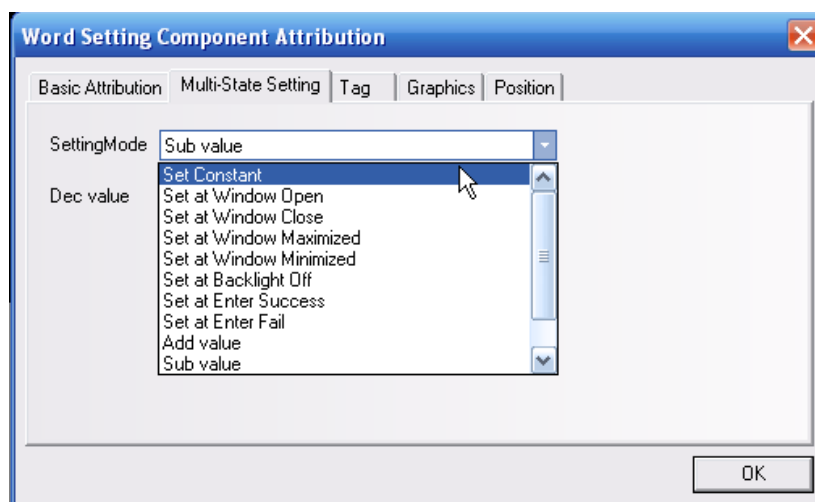

Setting Mode: As shown in the following table:

Type	Description
Set Constant	When the component is pressed (touched), preset constant data will be written to the designated PLC word register. (the constant is set in the “ Set Value ” box.)
Set at window open	To initialize the designated Word Register with a constant value at the time of window open. This operation is only applicable for LW (local word). (Enter the constant in the “ Set Value ” box.)
Set at window close	To set designated word register with a constant value at the time of window close. This operation is only applicable for LW (local word). (Enter the constant in the “ Set Value ” box.)
Set at window Max.	To initialize the designated PLC Word register at the time window is maximized. (Enter the constant in the “ Set Value ” box.)
Set at window Min	To initialize the designated PLC Word register at the time window is minimized. (Enter the constant in the “ Set Value ” box.)
Set at back light OFF	Set when the back light is turned OFF (Enter the constant in the “ Set Value ” box).
Set at successful input	Set when the numeric or text component conduct a successful input operation (Enter the constant in the “ Set Value ” box).
Set at input failure	Set when the numeric or text component conduct a unsuccessful input operation (Enter the constant in the “ Set Value ” box).
JOG+	Every time the component is pressed, the incremental value is added to the current value of the designated PLC word address, if the result is not larger than upper limit. The incremental value is set in the “Inc. Value” field
JOG-	Every time the component is pressed, the decreased value is subtracted from the current value of the designated PLC word address, if the result is not less than lower limit.
JOG++	When the component is pressed and held for a time longer than Delay Time , the incremental value is added to the current value of the designated PLC word address in every interval of Execution Speed . The increased amount is the Incremental Value .
JOG--	When the component is pressed and held held for a time longer than Delay Time , the decreased value is added to the current value of the designated

PLC word address in every interval of Execution Speed . The decreased amount is the Decreased Value .

3. Go to the **Graphics** tab: Select vectogram or bitmap to indicate the corresponding address states and represent the touch area.
4. Go to the **Label** tab: Fill in text to denote states.
5. Go to the **Position** tab, adjust the position and size of the word setting component if necessary.
6. Click **OK** button to complete the setting of the word setting component.

6.5 Multi-State Display



A multi-state display component changes its appearance according to the value of related PLC word address. If the value of the word register is 0, the graphic corresponding to state 0 will be displayed. If the value equals to 1, the shape corresponding to state 1 will be displayed, and so on. The corresponding label will also be displayed if the option **Use Tag** is enabled.

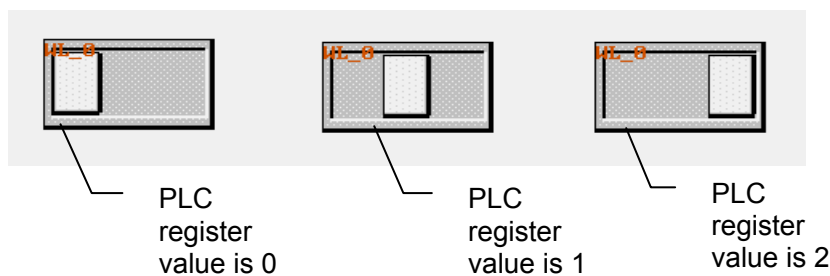

► Adding a multi-state display component

1. Click the multi-state display component icon and drag it to the edit window, the **Basic Attribution** tab of the **Component Attribution** dialogbox appears.

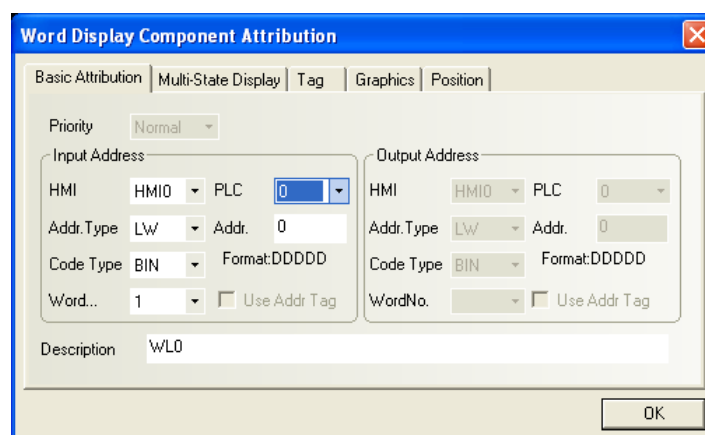

Priority: Reserved function, not used for the time being.

- **Input Address:** PLC word register address that controls the state, shape and label

information of the multi-state display component.

Address: The address of the word registers corresponding to the multi-state display component. The usage of register address varies with different PLCs; refer to PLC manual for detailed information.

Code Type: BIN or BCD.

No. of Words: Select 1 or 2 for input address (single word or double word).

Use Address Tag: Whether to use the address entered in the address tag library. For details, refer to Section 6.34.

Description: A reference name (not displayed) that you assign to the multi-state display component.

- Go to the **Multi-State Display** tab and set the number of states for multi-state display component. The user can set a maximum of 32 states.

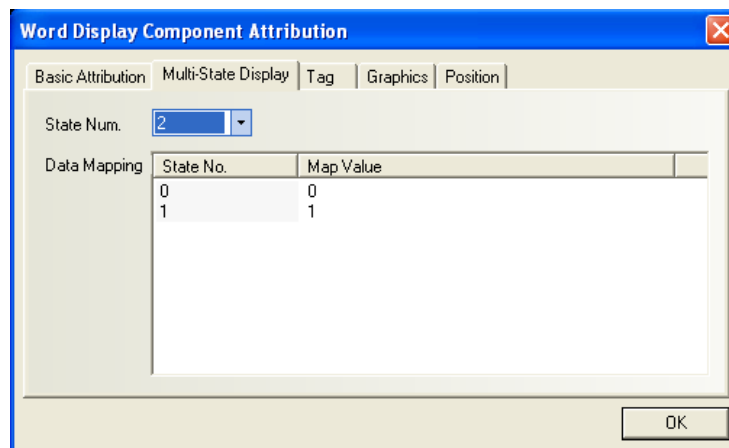

Data mapping: Every state of the multi-state display component is linked to a unique value of the designated PLC word register. When the register value equals to one of the Map Values in the mapping list, the multi-state display component will display the corresponding state. The mapping detail is listed in the **data mapping** list, the user can view and edit the mapping relationship between state number and register value.

- Go to the **Tag** tab: Fill in text to denote different states (or leave it empty).
- Go to the **Graphic** tab: select a vectogram or bitmap to display the state graphic of the multi-state display component.
- Go to the **Position** tab, adjust the position and size of the multi-state display component if necessary.
- Click the **OK** button to complete the setting of the multi-state display component.

Note on Data Format Types

BIN (binary format)

15 14 13 12 11 10 9 8 7 6 5 4 3 2 1 0

2^{15}	2^{14}	2^{13}	2^{12}	2^{11}	2^{10}	2^9	2^8	2^7	2^6	2^5	2^4	2^3	2^2	2^1	2^0
----------	----------	----------	----------	----------	----------	-------	-------	-------	-------	-------	-------	-------	-------	-------	-------

BCD (binary coded decimal format)

15 14 13 12 11 10 9 8 7 6 5 4 3 2 1 0

10^3	10^2	10^1	10^0
thousand	hundred	ten	one

For example:

10010100 (BIN data) = $1*2^7 + 0*2^6 + 0*2^5 + 1*2^4 + 0*2^3 + 1*2^2 + 0*2^1 + 0*2^0$ (decimal data) = $128 + 16 + 4 = 148$

1001 0100 (BCD data) = $9*10^1 + 4*10^0$ (decimal data) = 94 (1001 (binary) = 9 (decimal), 0100 (binary) = 4 (decimal))

6.6 Multi-State Switch



The **Multiple State Switch** is a combination of multi-state display component and multi-state setting component. It displays different states (a maximum of 32 states) depending on the value of the PLC word address. It also defines a touch area that, when activated, writes a specified data to the PLC word register. The input address can be the same as the output address or different from it.

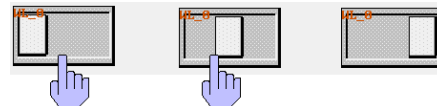

► Adding a Multi-State Switch

1. Click the multi-state switch icon and drag it to the window, the **Basic Attribution** tab of the **Component Attribution** dialogbox appears.

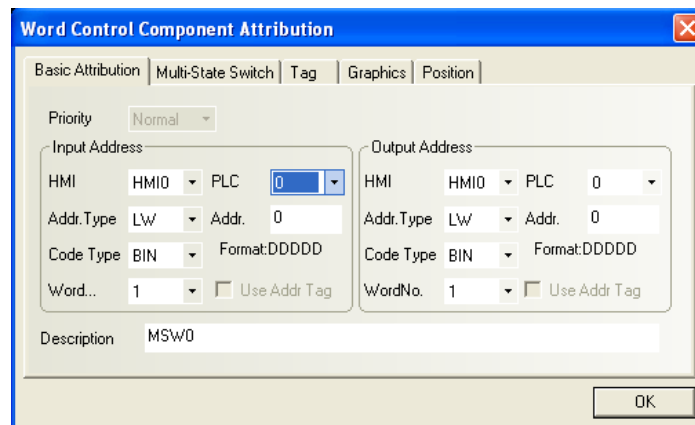

Priority: Reserved function, not used for the time being.

➤ **Input Address:** PLC register address that controls the state, shape and label information of the multi-state switch.

➤ **Output Address:** Address of the PLC register controlled by the multi-state switch.

Address: The address of the word register corresponding to the multi-state switch. The address type must be properly set, refer to PLC manual for detailed information.

Code Type: BIN or BCD.

No. of Words: Select 1 or 2 for single word and double word., respectively

Use Address Tag: Whether to use the address entered in the address tag library. For details, refer to Section 6.34.

Description: A reference name (not displayed) that you assign to the multi-state switch.

2. Go to the **Multi-State Switch** tab and set the number of states and data mapping list for the multi-state switch component. The user can set a maximum of 32 states.

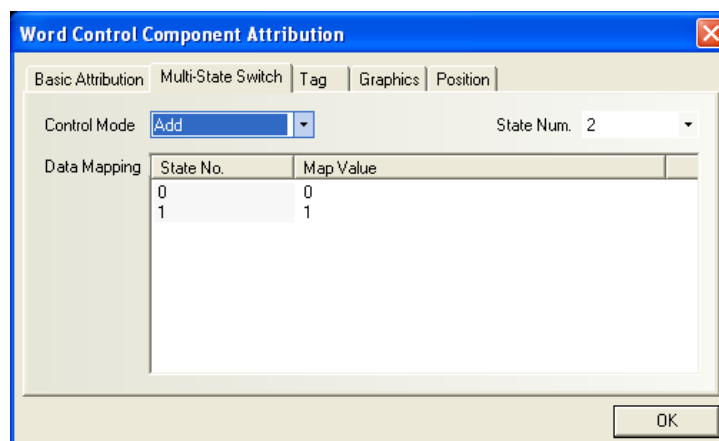

Functions of Multi-State Switch Setting mode:

Type	Description
JOG+	When the Multi-State Switch is pressed, the value in the designated output address register is increased by one. If the result equals to one map value in the mapping list, the corresponding state will be displayed.
JOG-	When the Multi-State Switch is pressed, the value in the designated output

address register is decreased by one. If the result equals to one map value in the mapping list, the corresponding state will be displayed.

Data mapping: Every state of the multi-state display component is linked to a unique value of the designated PLC word register. When the register value equals to one of the Map Values in the mapping list, the multi-state display component will display the corresponding state. Since the multiple state switch component can write and read the register, when the switch is set to a new state, the corresponding map value will be written to the designated word register. The mapping detail is listed in the **data mapping** list, the user can view and edit the mapping relationship between state numbers and register values

3. Go to the **Label** tab: Fill in text to denote states.
4. Go to the **Shape** tab: Click the vectogram or bitmap to display the register states and represent the touch area.
5. Go to the **Position** tab, and adjust the position and size of the multi-state switch component if necessary.
6. Click **OK** to complete the setting of the multi-state switch component.

6.7 XY Plot



XY plot is a curve which shows the relationship between two variables in a vivid way. Two neighbouring word registers form a pair. The lower register contains the value representing the X axis while the higher one corresponds to the Y axis. Such a pair of registers represents a sampling point. A curve consists multiple smapling points must use the same number of register pairs.

For example : Suppose an XY plot component containing M channels, each chanel contains N sampling points on each page. For this XY plot on one page, the required registers in PLC cover a continous area of $M \times N \times 2$ words, as shown below:

$X_{11}, Y_{11}, X_{12}, Y_{12}, \dots, X_{1N}, Y_{1N}, \dots, \dots, X_{M1}, Y_{M1}, \dots, X_{MN}, Y_{MN}$

Note: For X_{ij} and Y_{ij} , the subscript i indicates channel number and j indicates sampling point. X_{ij} indicates the horizontal axis value of the sampling point j in the channel i.

► Adding an XY plot component

1. Click the XY plot icon and drag it to the window, the **Basic Attribution** tab of the **Component Attribution** dialogbox appears.

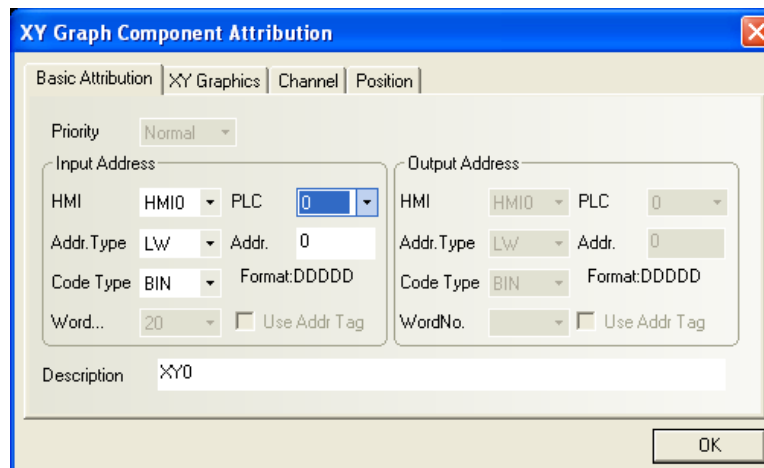

Priority: Reserved function, not used for the time being.

- **Input Address:** PLC word register address corresponding to the designated X axis track data, the word address corresponding to Y axis is **input address + 1**; If there are more than one channel, the corresponding address of the second channel is: X axis: input address + 2 × number of sampling points; Y axis: input address + 2 × number of sampling points + 1, and so on.

Address: The address of the word register corresponding to the XY plot.

Code Type: BIN or BCD.

No. of Words: Depend on the number of channels, number of sampling points, and current address type of XY plot. It is calculated by system, not settable by the user.

Use Address Tag: Whether to use the address entered in the address tag library. For details, refer to Section 6.34.

Description: A reference name (not displayed) that you assign to the XY graph component.

2. Go to the **XY Graphics** tab and set related parameters.



Type: Single page or multiple pages.

If the user selects the single page mode, it will only display the data change of the sampling points in the current page. Points out of that page will not be saved or displayed. If the user

selects multiple-page display mode, each channel of the XY graph can save: number of pages × number of sampling points. In this way, when the XY graph rolls forward, the previous sampling data will not be lost. Historical data will be saved to the memory for future reference. Please note that a maximum of 31 pages of historical data are available, which is determined by the **No. of pages** parameter.

Attribute: Start from left or Start from right. In other words, it determines whether the graph is displayed from the left to right or from the right to left when displaying sampling data.

Sampling Time: Time interval between two pages of sampling points, in seconds.

No. of Sampling Points: Number of sampling points displayed on the graph.

No. of Pages: When the **Type** is set to “**Multiple Pages**”, this box is available.

Channel: Number of tracks to be displayed, corresponding to the number of word registers. Two word registers correspond to one track.

Hold(Keep): The bit address that controls the start or stop of the XY graph; in other words, the sampling data stops when the [**Hold**] bit is turned ON, and the sampling continues and XY graph will be dynamically displayed when the [**Hold**] bit is turned OFF again.

Scroll: This address has to cooperate with the scrolling bar, that is, the user can view the XY graph by directly moving the scroll bar. Set the scrolling address the same as the address of the scrolling bar component to be associated. For details, refer to Section 6.27 “Scroll Bar”.

Time: When the **Save Time** check box is selected, the **Time** box in the lower part of the window will be available. It includes 12 words used to save the time of the latest sampling point. The 12 words contain the “second, minute, hour, day, month, year” of the start point and the “second, minute, hour, day, month, year” of the end point in the current page. Each word represents a time point.

3. Go to the **Channel** tab and set related parameters of each track.

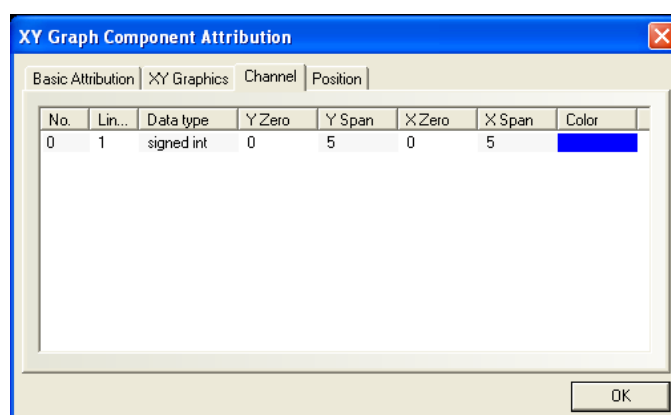

Color: Designate the color of each track.

Line Width: The width of a line, including 8 options.

Data Type: Sets the data type, with only two options of signed integer and unsigned integer.



Max. and Min Value in X Direction: Set the corresponding maximum and minimum values of each track line along the Y direction. When a read value from the corresponding register is greater than the maximum value or less than the minimum value, the maximum value or the minimum value will be displayed on the graph.

Max. and Min Value in X Direction: Set the corresponding maximum and minimum values of each track line along the X direction. When a read value from the corresponding register is greater than the maximum value or less than the minimum value, the maximum value or the minimum value will be displayed on the graph.

4. Go to the **Position** tab, and adjust the position and size of the XY graph component if necessary.
5. Click **OK** to complete the setting of the XY plot component.

6.8 Moving Component



The Moving Component tool is used to place a vectogram or bitmap on the window at a location specified by the PLC register. The state and the absolute location of the shape on the window depend on current reading value of three continuous PLC registers. Typically, the first register controls the state of the component. The Second register controls the horizontal position (X), and the third register controls the vertical position (Y).

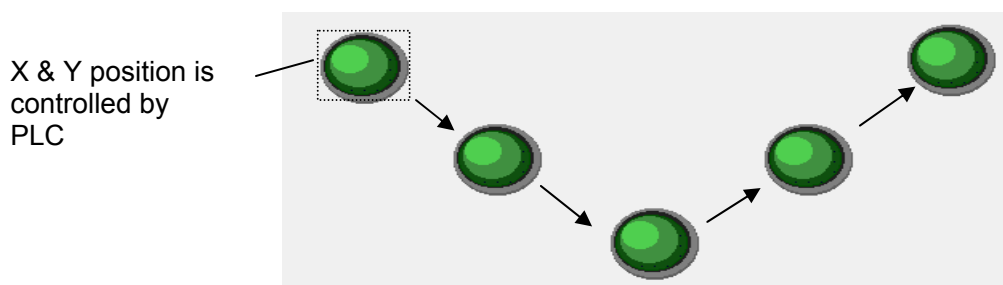

► Adding a moving component

1. Click the moving component icon and drag it to the window, the **Basic Attribution** tab of the **Component Attribution** dialogbox appears.

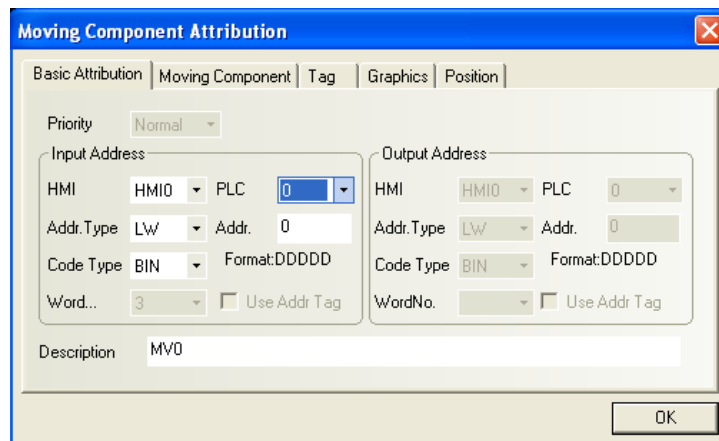

Priority: Reserved function, not used for the time being.

- **Input Address:** The initial address of the word registers that controls the state, shape and label information of the moving component in the PLC. The first register is at the lowest address.

Address: The initial address of the word registers corresponding to the moving component.

Code Type: BIN or BCD.

No. of Words: Select 3 for input address. (It is automatically set by system, disabled for edit)

Use Address Tag: Whether to use the address entered in the address tag library. For details, refer to Section 6.34.

Description: A reference name (not displayed) that you assign to the moving component.

2. Go to the **Moving Component** tab and set moving type, number of states, and maximum and minimum values along XY axes.

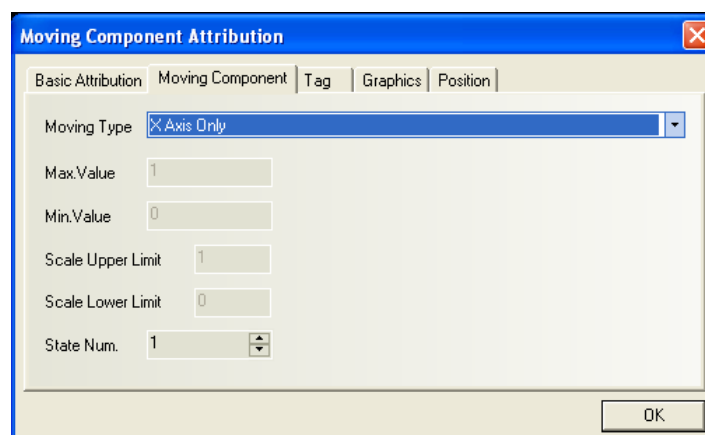

Type and Function Table:

Up to 32 different states can be assigned to the components in EV5000 software. When the

component has only one state, the value of the register specified by the Read Address (“input address” in the “Basic Attribution” tab) must be held 0, otherwise the component may not be displayed. The state numbers 1 ~32 correspond to internal register values 0~31 respectively. The position is controlled as shown in the table below. Position is relative to the original location of shape. (X axis indicates the horizontal axis and Y axis indicates the vertical axis).

Control Mode	X	Y	X & Y
Length of Read Data	2 words	2 words	3 words
Lowest word	Component State (an integer between 0 and 31)	Component State (an integer between 0 and 31)	Component State (an integer between 0 and 31)
2 nd word (Read Address + 1)	X displacement	Y displacement	X displacement
3 rd word (Read Address + 2)	N/A	N/A	Y displacement

Moving modes are as follows:

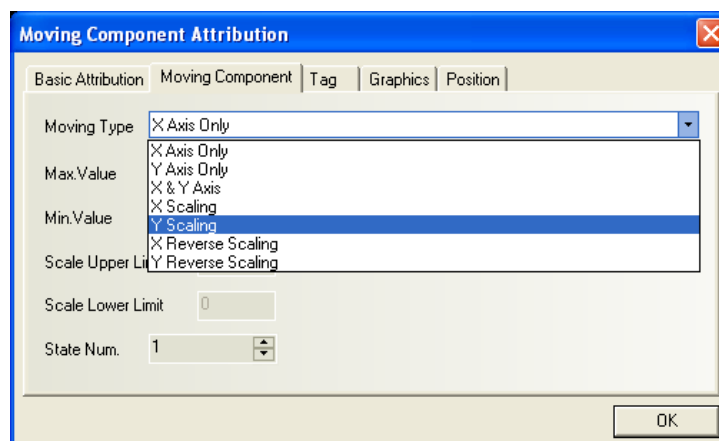

The moving modes are described as follows:

X axis only	When this option is selected, the component will move horizontally along the X axis. At this time, the input maximum (minimum) value will be invalid, the first register stores component state, and the second register stores position.
Y axis only	When this option is selected, the component will move vertically along the Y axis. At this time, the input maximum (minimum) value will be invalid, the first register stores component state, and the second register stores position.
X & Y axis	When this option is selected, the component will move along

	the X & Y axis. At this time, the input maximum (minimum) value will be invalid, the first register stores component state, the second register stores X position, and the third register stores Y position.
X Scaling	When this option is selected, the component will move horizontally along the X axis only, but the user can set relative movement position by set input register value limits and scaling value limits (for example, when the read PLC register value range is 0 ~ 1000, but the relative moving position range on the screen is 0 ~ 640. The lower and upper limits of the scaling value can be set to 0 and 640 respectively; the lower and upper limits of the input value can be set to 0 and 1000 respectively). The first register stores component state and the second register stores position.
Y Scaling	When this option is selected, the component will move horizontally along the Y axis only, but the user can set relative movement position by set input register value limits and scaling value limits (for example, when the read PLC register value range is 0 ~ 1000, but the relative moving position range on the screen is 0 ~ 640. The lower and upper limits of the scaling value can be set to 0 and 640 respectively; the lower and upper limits of the input value can be set to 0 and 1000 respectively). The first register stores component state and the second register stores position.
X Reverse Scaling	The function is the same as the X scaling, but at an opposite direction.
Y Reverse Scaling	The function is the same as the Y scaling, but at an opposite direction.

When **scaling** is used, scaling is performed as follows:

$$\text{Display value} = \text{Current position} + \frac{(\text{Reading value} - \text{Input Min.}) \times (\text{Scaling max.} - \text{Scaling Min.})}{(\text{Input Max.} - \text{Input Min.})}$$

When **reverse scaling** is used, scaling is performed as follows:

$$\text{Display value} = \text{Current position} + \frac{(\text{Input Max.} - \text{reading value.}) \times (\text{Scaling max.} - \text{Scaling Min.})}{(\text{Input Max.} - \text{Input Min.})}$$

3. Go to the **Label** tab: Fill in text to be displayed.
4. Go to the **Graphics** tab: Select vectogram or bitmap to represent motion or to display states.
5. Go to the **Position** tab, and adjust the position and size of the moving component if necessary.
6. Click OK to complete the setting of the moving component.

6.9 Animation



The Animation Component is used to place an object on the window at a specified location determined by a predefined path and data in the PLC. The state and the absolute location of the shape on the window depend on current reading value of two continuous PLC registers. Typically, the first register controls the state of the object, and the second controls the position along the predefined path. As the PLC position register changes value the vectogram or bitmap jumps to the next position along the path.

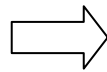
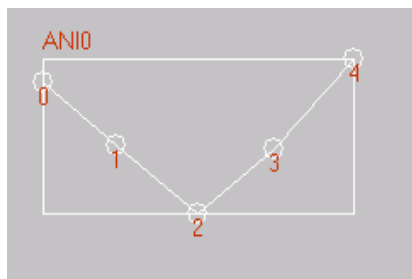

Predetermined path

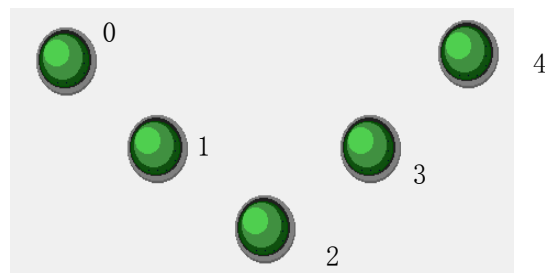

Graphics is roaming on the predefined path when (read address +1) = 0, 1, 2, 3, 4

► Adding an Animation component

1. Click the **Animation** icon.
2. Click on screen to define the path and the moving nodes for the object to travel, click on each moving node one by one to set the path, and then right click to complete the setup of path.
3. Double click on the animation component, and the following dialog box appears. Fill in the **Basic Attribution** tab.

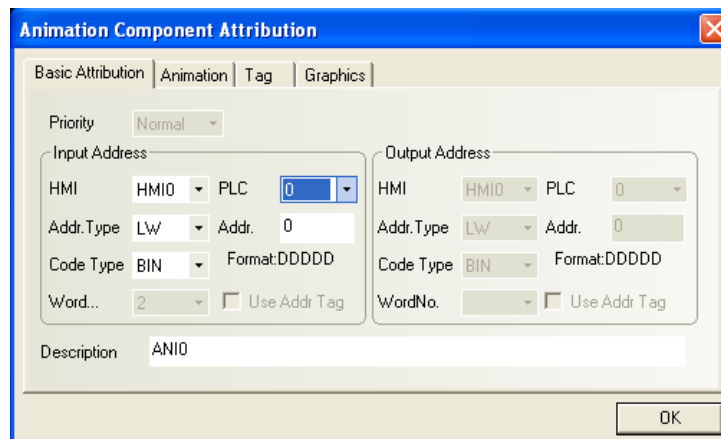

Priority: Reserved function, not used for the time being.

Input Address (Read Address): The word address that controls state and label of the Animation component in the PLC. **Read Address + 1** is the word register address that controls the position of the Animation component. Data in the register may be interpreted as BIN or BCD format (refer to Multi-State Display component). The **No. of Words** is restricted to 2.

Address: The lower word register address corresponding to the animation component.

Code Type: BIN or BCD.

No. of Words: It is restricted to 2 for input address.

Use Address Tag: Whether to use the address entered in the address tag library. For details, refer to Section 6.34.

Description: A reference name (not displayed) that you assign to the animation component.

4. Go to the **Animation** tab:

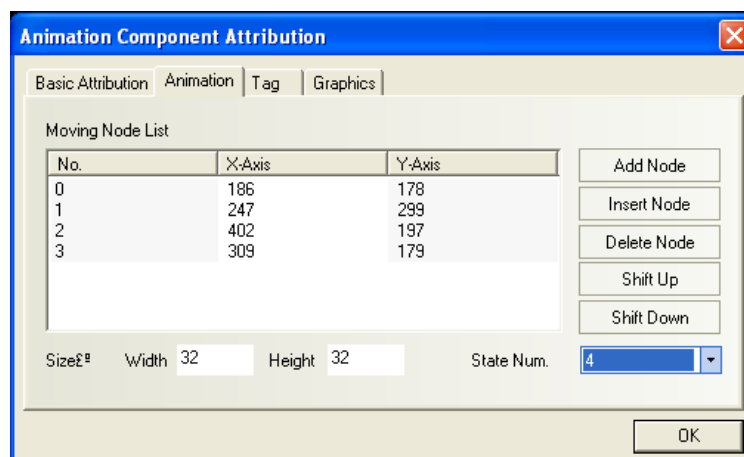

No. of States: Select the total number of states for the animation component. This determines the number of states of vectograms or bitmaps that will be displayed along the predetermined path.

Add Node: Add a new moving node to the end of the current predetermined path.

Insert Node: Insert a new moving node after the moving node being selected.

Delete Node: Delete the selected moving node

Shift Up: move the selected node to the position before the previous one.

shift Down: move the selected node to the position after the next one.

Size of Graphics: the size of the graphic representing the moving object.

Node 0 (1, 2, 3...): Select a designated track node. Point 0 is the start node, point 1 is the second node, and so on. The total number of moving nodes depends on the number of moving nodes placed on the screen when. X(Y) corresponds to the coordinate position of the moving nodes, where you can edit the coordinate position of each node. .

5. Go to the Tag tab: If you want to use tags for different state, check “Use Tag” and Fill in text to be displayed.
6. Go to the Graphics tab: Select a vectogram or bitmap to represent moving objects, the selected graphic must have more states than the number of state of the animation component.
7. Click OK to complete the setting.

Read Data Assignment:

Read Address	Object state
Read Address + 1	Position number on the path

◆ The following is an example showing how to use the animation component.

6.9.1 Adding an animation component

The settings are as follows:

Read data: LW1 (BIN format), state control

LW2 (BIN format), position control

No. of states: 4

Number of positions : 4

Selection of state graph:

State 0

State 1

State 2

State 3

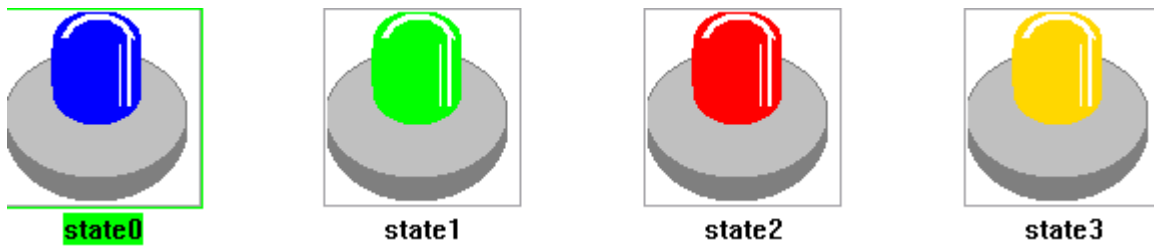

Display current reading value

Touch the part area to activate the data input

Enter data by customer tailored keypad

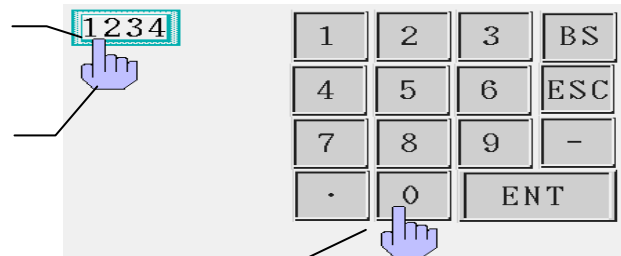

6.9.2 Presetting the screen track nodes

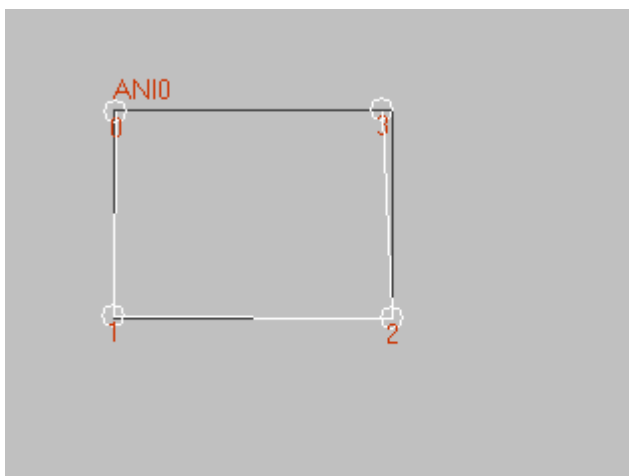

(1) When LW1=0, LW2=0

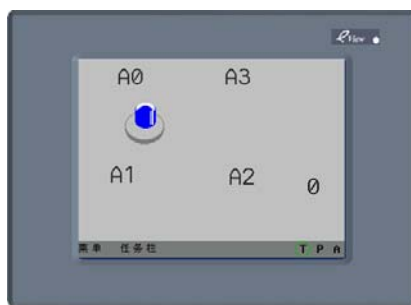

(3) When LW1=2, LW2=2

(2) When LW1=1, LW2=1

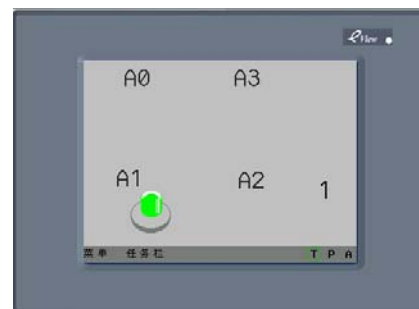

(4) When LW1=3, LW2=3

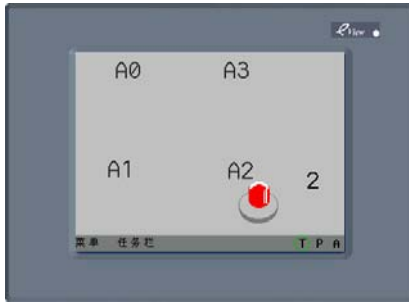

6.10 Number Input

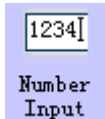

The Number Input component displays the current value of a PLC register data and can pop-up a small keypad for the user to change the register data. If the **Trigger Address** bit is ON, once the number input component area is touched, the Numeric Input component will be activated for data entry. Use the keypad to enter data to the PLC register designated by **Input Address**. It is a frequently used part for monitoring and changing PLC register data.

► Adding a Numeric Input

1. Click the numeric input component icon and drag it to the window, the Basic Attribution tab of the component attributions dialogbox appears.

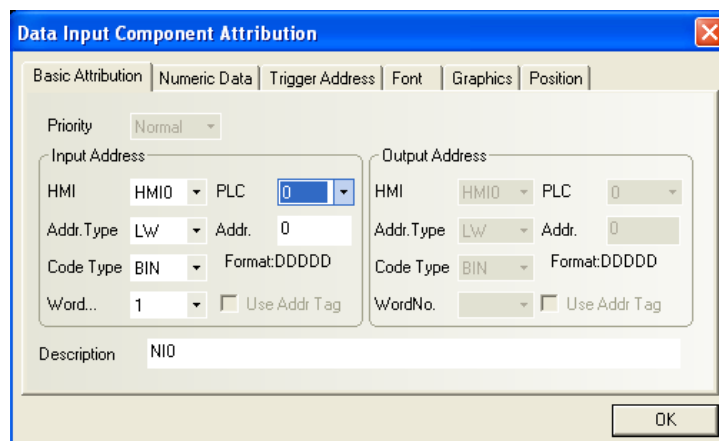

Priority: Reserved function, not used for the time being.

Input Address: The starting address of PLC word register to be displayed and modified by numeric input component. Data in the register may be interpreted as BIN or BCD format (refer to Multi-State Display component). The No. of words is restricted to 1 (16 bits) or 2 (32 bits).

Address: The PLC word register address corresponding to the numeric input component.

Code Type: BIN or BCD.

No. of Words: Select 1 or 2 for input address.

Use Address Tag: Whether to use the address entered in the address tag library. For details, refer to Section 6.34.

Description: A reference name (not displayed) that you assign to the numeric input component.

2. Go to the **Numeric Data** tab:

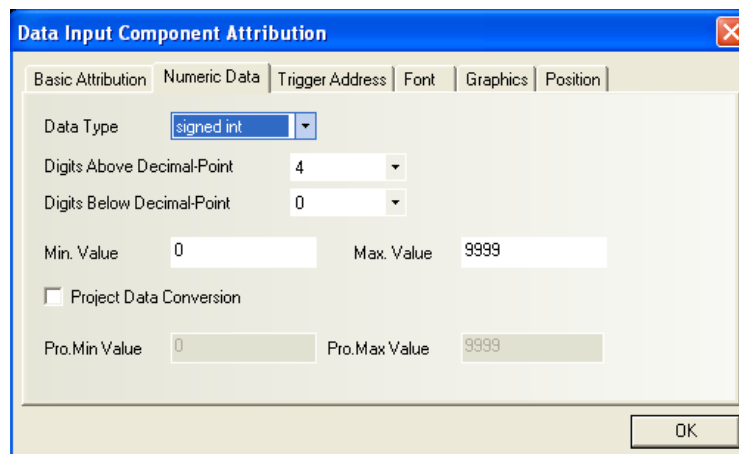

Data Type: Control the input format of data, including “Signed integer”, “Unsigned integer”, “Hex”, “Binary”, “Mask”, “Single float”, and “Double float”. For details, refer to “Numeric Display Format” later in this section.

Numeric Setting: Set the position of the decimal point, number of digits, max. value, and min. value.

Project Data conversion (Engineering data conversion): Applicable only to two data types of “Signed integer” and ‘Unsigned integer’.

3. Go to the **Trigger Address** tab: Enter the trigger bit address, which enables the numeric input component. Only when the trigger bit address is ON will the numeric input operations be valid. Since LB9000 ~ 9009 are internal reserved addresses initialized to be ON after startup, the component uses LB9000 as the default trigger address. (For details about system reserved registers, see chapter 11)

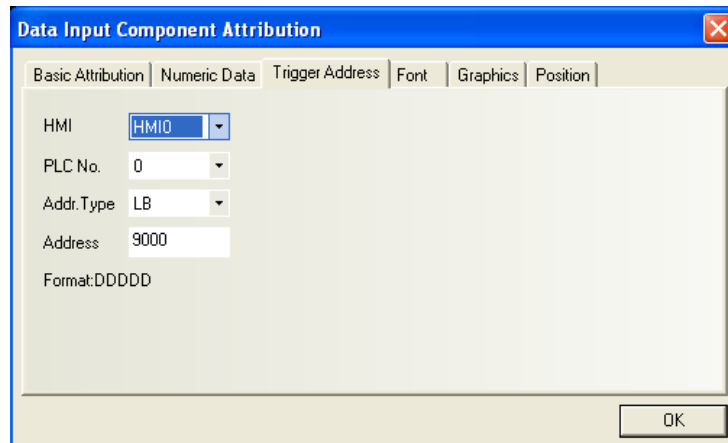

4. Go to the **Font** tab: Set the size, color, and alignment mode of display numeric digits.

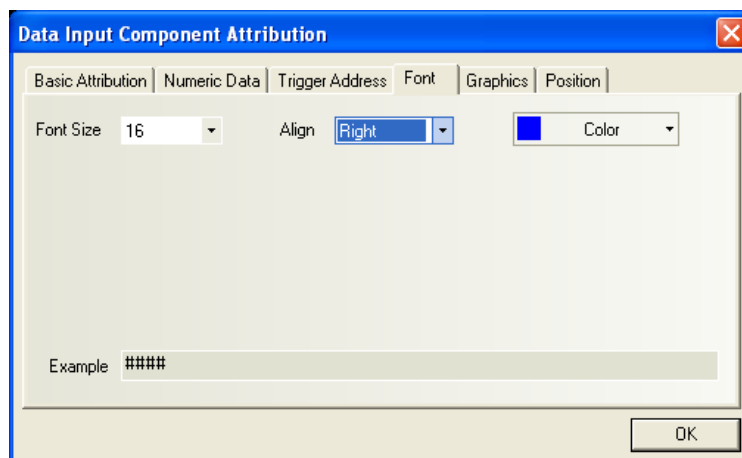

Font Size: Set font size, including such options as 8, 16, 24, 32, 48, 64, 72 and 96.

Align: Applicable only to decimal format, that is, two data types of “Signed integer” and “Unsigned integer”. For example, set “integer digit” = 5, “decimal digit” = 0, and enter the number 123. The display format covers:

Align right	1 2 3
Left	1 2 3
Leading zero	0 0 1 2 3

5. Go to the Graphics tab: Select vectogram or bitmap to enhance display effect. The graphic selected here can be used as the background of the digits.

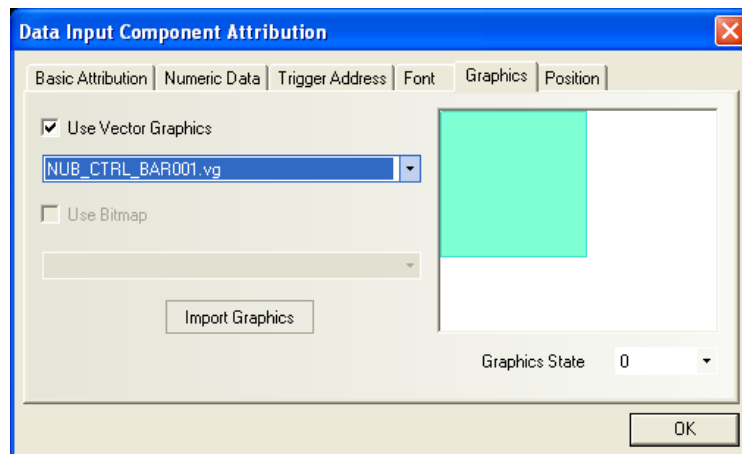

- Click **OK** to complete the setting and place the numeric input component in an appropriate position.

Numeric Display Format:

(1) Signed integer and unsigned integer: Data displayed in decimal format (0~9). Only when these two option is selected will the Engineering data conversion function enabled:

The reading value is displayed in its original value and mark decimal point in the position specified by the “Digits below decimal point”. For example, if the “Digits below decimal point” = 2, a reading value “14561” is displayed as 145.61.

Engineering Data Conversion: The reading value is converted to its engineering unit before display. Scaling is performed as follows:

Conversion value = Engineering Min. +

$\frac{(\text{Reading value} - \text{Input Min.}) * (\text{Engineering Max.} - \text{Engineering Min.})}{(\text{Input Max.} - \text{Input Min.})}$

The conversion value will be displayed according to the setting of “digits above decimal point” and “digits below decimal point”. For example if conversion value is 123.456 and the digits below decimal point = 2, digits above decimal point = 3, then the conversion value is displayed as “123.45”, the last digit is truncated.

(2) Hex: The number is displayed in hex (0~F) format, scaling and decimal point are disabled.

FFFF

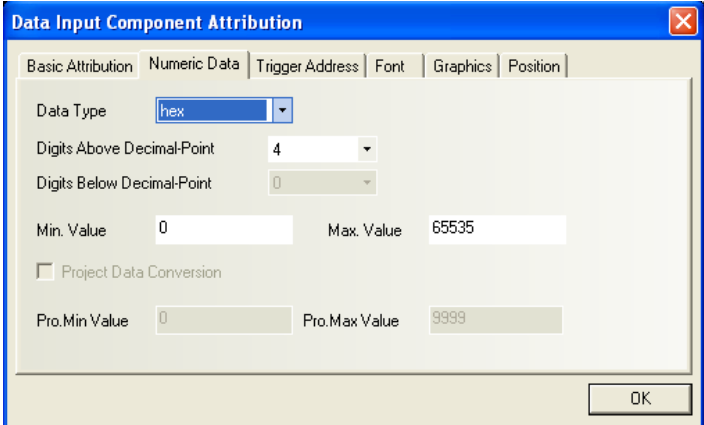

(3) **Binary:** The number is displayed in binary (0~1) format, scaling and decimal point are disabled.

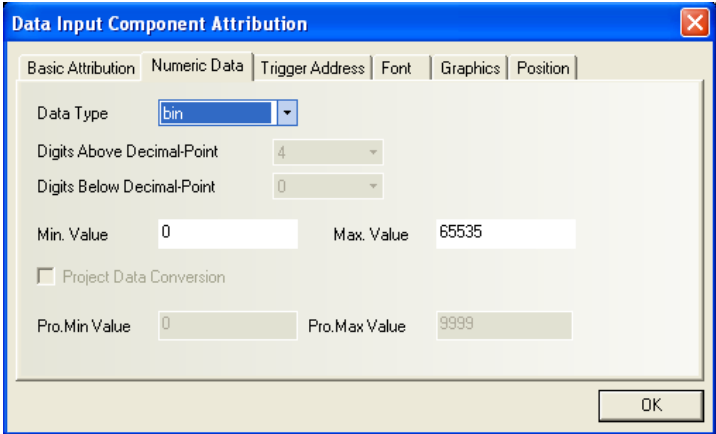

In case of Hex and binary formats, the maximum and minimum input values are regarded as unsigned binary data.

(4) **Password:** Display only "****" for any reading value. This is used for password input, scaling and decimal point are disabled.

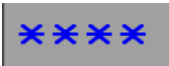

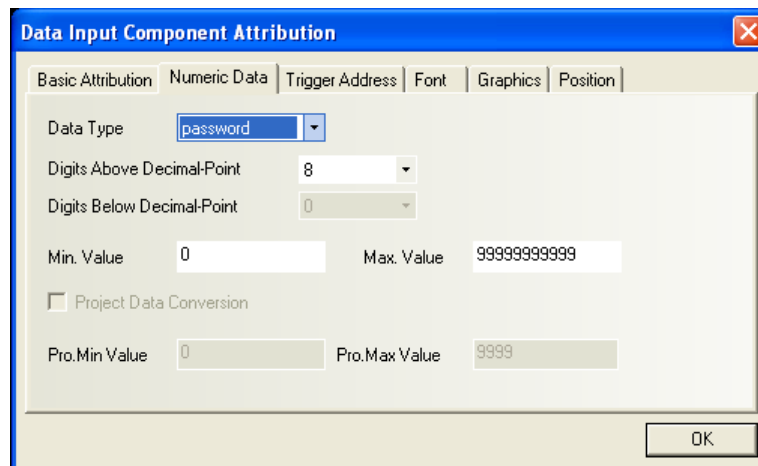

(5) Single float: Data from the controller register is translated from a 32-bit IEEE Floating-Point format to a decimal number and displayed.

(6) Double float: Data from the controller is translated from a 64-bit IEEE Floating-Point format to a decimal number and displayed.

When input data, the Input Min. and Input Max. limit the range of valid input data, and Engineering Max. and Engineering Min. limit the range of valid input data if **“Project (Engineering) Data Conversion”** is selected.

If **“Project (Engineering) Data Conversion”** is selected,

the value written to the PLC = $\frac{(\text{Input data} - \text{Engineering Min.}) \times (\text{Input Max.} - \text{Input Min.})}{(\text{Engineering Max.} - \text{Engineering Min.})}$

+ Input Min.

Single Float format (32 bits)

S	e[30:23]	f[22:0]
3	30	22
1	23	0

Single Float Bit Pattern	Value
$0 < e < 255$	$(-1)^S \times 2^e \times 127 \times 1.f$
$e=0 ; f \neq 0$	$(-1)^S \times 2^{-126} \times 0.f$
$e=0 ; f=0$	$(-1)^S \times 0.0$
$s=0, e=255, f=0$	Positive infinity
$s=1 ; e=255 ; f=0$	Negative infinity
$s=0 \text{ or } 1 ; e=255 ; f \neq 0$	Invalid number

Double Float format (64 bits)

S	e[62:52]	f[51:32]
6	62	51
3	52	32

f[31:0]
31
0

Double Float Bit Pattern	Value
0 < e < 2047	$(-1)^S \times 2^{e-1023} \times 1.f$
e=0 ; f != 0	$(-1)^S \times 2^{-1022} \times 0.f$
e=0; f=0	$(-1)^S \times 0.0$
s=0, e=2047, f=0	Positive infinity
s=1; e=2047; f=0	Negative infinity
s=0 or 1; e=2047; f!=0	Invalid number

The above format is in accord with IEEE standard 754, and the arithmetic model is specified by the IEEE standard for Binary Floating Arithmetic.

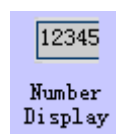
6.11 Numeric Display

A Numeric Display component displays the current reading of a designated PLC register data. No vectogram or bitmap can be associated with this component.

1234

► Adding a Numeric Display component

1. Click the numeric display component icon and drag it to the window, the basic attribution tab of the component attribution dialogbox appears.

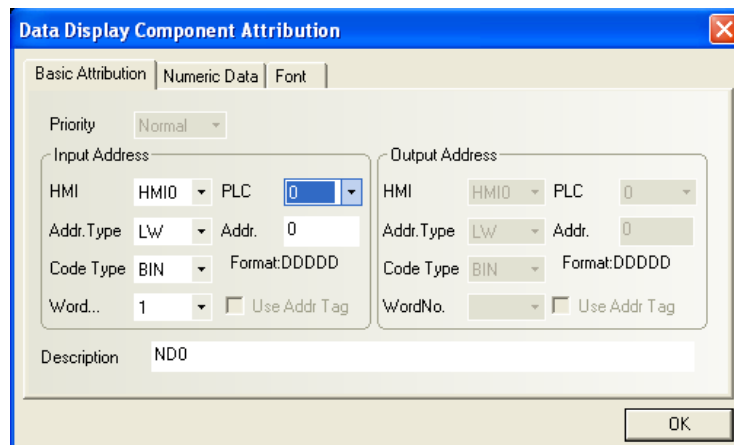

Priority: Reserved function, not used for the time being.

Input Address: The starting address PLC word register to be displayed by a numeric display component. Data in the register may be interpreted as BIN or BCD format (refer to Multi-State Display component). The No. of words is restricted to 1 (16 bits) or 2 (32 bits).

Address: The word register address corresponding to the numeric display component.

Code Type: BIN or BCD.

No. of Words: Select 1 or 2 for input address.

Use Address Tag: Whether to use the address entered in the address tag library. For details, refer to Section 6.34.

Description: A reference name (not displayed) that you assign to the numeric display component.

- Fill in the **Numeric data** tab by referring to related contents in the **Numeric Input** component.

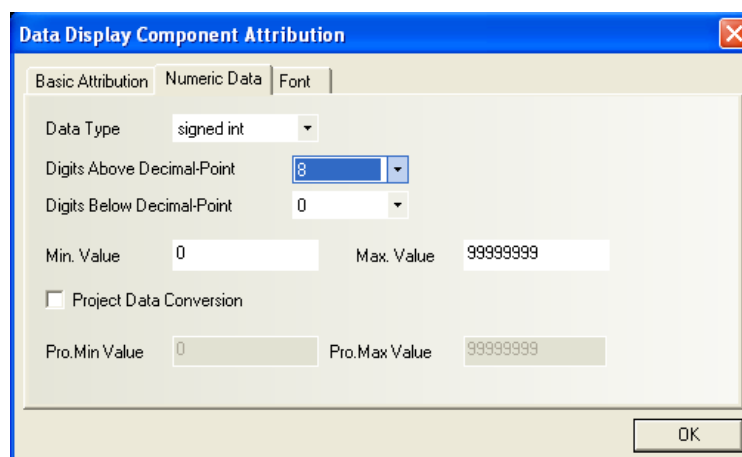

Data Type: Control the display format of data, including “Signed integer”, “Unsigned integer”, “Hex”, “Binary”, “Password”, “Single float”, and “Double float”.

Numeric Setting: Set the position of the decimal point, number of digits, max. value, and min. value.

Engineering Data conversion: Applicable only to two data types of “Signed integer” and “Unsigned integer”.

- Go to the **Font** tab: Set related parameters by referring to the **Numeric Input** component.

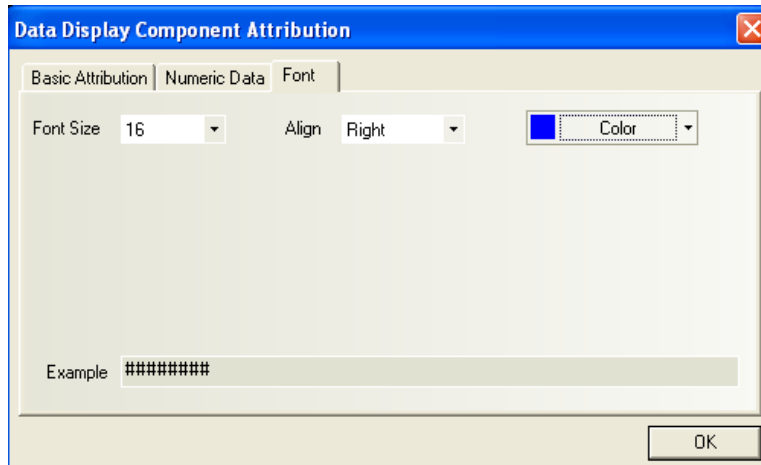

- Click OK to complete the setting and place the numeric display component in an appropriate position.

6.12 Text Input



A Text Input display current value of the PLC register data as decoded by the standard ASCII character table. If the **[Trigger Address]** is active (turned ON), when the shape area is touched, text input will be available through an keypad. Entered data is put into consecutive PLC registers starting with the **[Input Address]**. The ASCII code stored in the lower byte is displayed on the left and the one stored in the higher byte is displayed on the right.

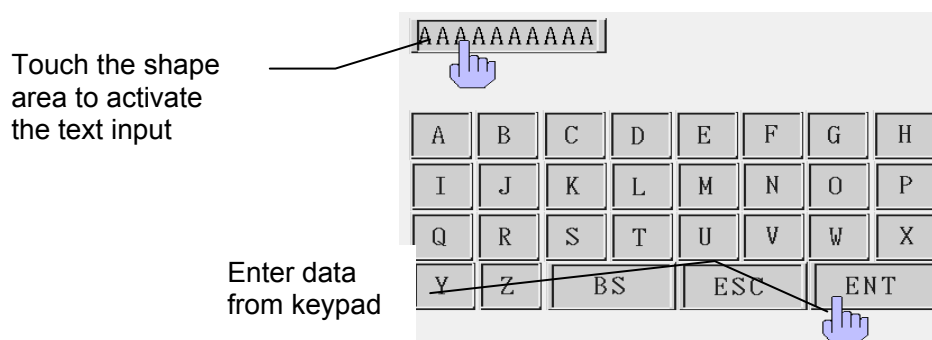

► Adding a Text Input Component

- Click the text input component icon and drag it to the window, the basic attribution tab of the component attribution dialogbox appears.

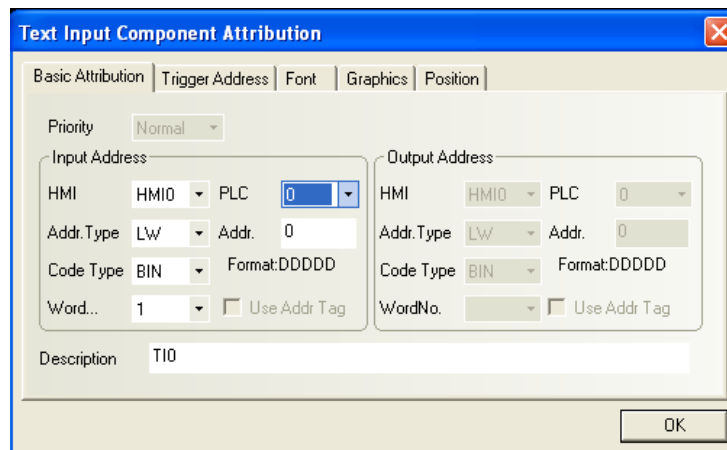

Priority: Reserved function, not used for the time being.

Input Address: The PLC word address registers to be displayed and modified by the text input component (a maximum of 16 words with each word containing two ASCII characters).

Address: The initial address of the word registers corresponding to the text input component.

Code Type: BIN or BCD.

No. of Words: 1 ~ 16 consecutive word registers can be selected for storing the characters.

Use Address Tag: Whether to use the address entered in the address tag library. For details, refer to Section 6.34.

Description: A reference name (not displayed) that you assign to the text input component.

2. Go to the **[Trigger Address]** tab: Enter the trigger address, which enables the text input component. Using LB9000 will make the text input component always enabled.

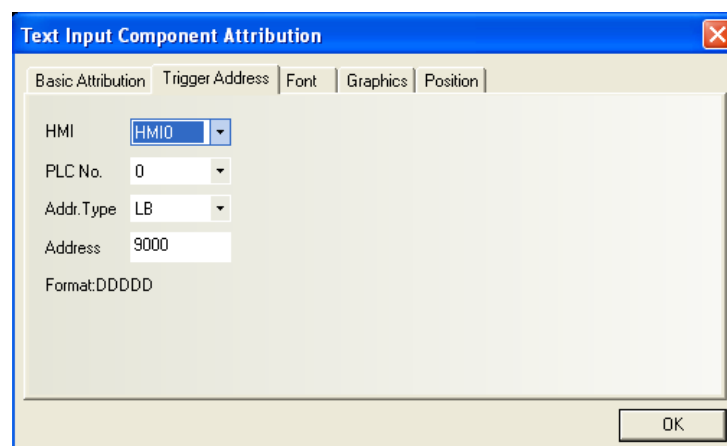

3. Go to the **[Font]** tab: Set the attributes of display data. Refer to the Numeric input component.
4. Go to the **[Graphics]** tab: Select vectogram or bitmap to display the state.
5. Click **[OK]** key to complete the setting and place the text input component on an appropriate position.

Note on the Storage Mode of Text Input:

In this example, the text input component uses 4 words for 8 characters.

1) When the Font/Align parameter is set to **Left**

When entering the character "A",



Highest word (Word)		Word 2 (Word)		Word 1 (Word)		Lowest Word 0 (Word)	
High byte	Low byte	High byte	Low byte	High byte	Low byte	High byte	Low byte
20(H)	20(H)	20(H)	20(H)	20(H)	20(H)	20(H)	41(H)
							A

When entering the character "AB",



Highest word (Word)		Word 2 (Word)		Word 1 (Word)		Lowest Word 0 (Word)	
High byte	Low byte	High byte	Low byte	High byte	Low byte	High byte	Low byte
20(H)	20(H)	20(H)	20(H)	20(H)	20(H)	42(H)	41(H)
						B	A

When entering the character "ABC",



Highest word (Word)		Word 2 (Word)		Word 1 (Word)		Lowest Word 0 (Word)	
High byte	Low byte	High byte	Low byte	High byte	Low byte	High byte	Low byte
20(H)	20(H)	20(H)	20(H)	20(H)	43(H)	42(H)	41(H)
					C	B	A

2) When the Font/Align parameter is set to **Right**

When entering the character "A",



Highest word (Word)		Word 2 (Word)		Word 1 (Word)		Lowest Word 0 (Word)	
High byte	Low byte	High byte	Low byte	High byte	Low byte	High byte	Low byte
41(H)	20(H)	20(H)	20(H)	20(H)	20(H)	20(H)	20(H)
A							

When entering the character "AB",



Highest word (Word)		Word 2 (Word)		Word 1 (Word)		Lowest Word 0 (Word)	
High byte	Low byte	High byte	Low byte	High byte	Low byte	High byte	Low byte

42(H)	41(H)	20(H)	20(H)	20(H)	20(H)	20(H)	20(H)
B	A						

When entering the character “ABC”,

ABC

Highest word (Word)		Word 2 (Word)		Word 1 (Word)		Lowest Word 0 (Word)	
High byte	Low byte	High byte	Low byte	High byte	Low byte	High byte	Low byte
43(H)	42(H)	41(H)	20(H)	20(H)	20(H)	20(H)	20(H)
C	B	A					

Some users would like to display the contents on the keypad when entering data. To implement this function, a text input component can be placed in the keypad to read the corresponding data between LW9060 and LW9075.

✧ **An example of the usage for LW9060 ~ LW9075 is shown as follows:**

1. Create a new project and add a text input component on window 0. Set the parameters as shown in the figures below, notice that the input component has 5 words for storage, so the user can input up to 10 characters.

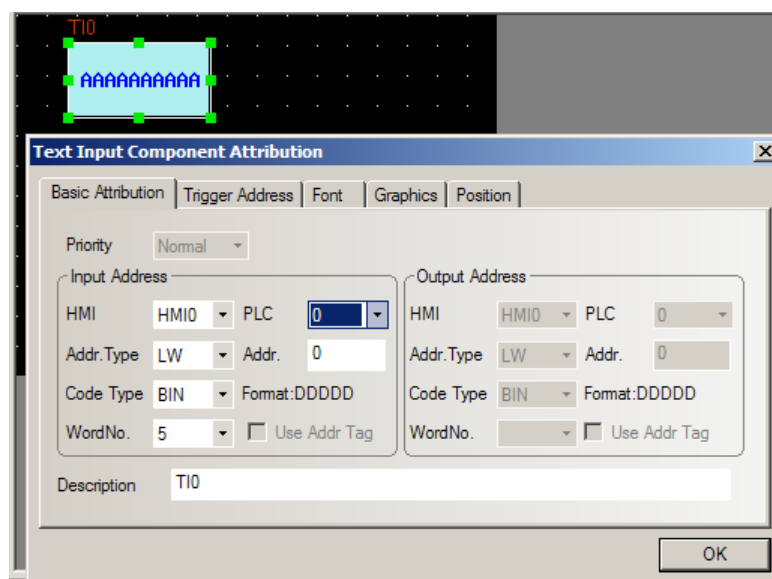

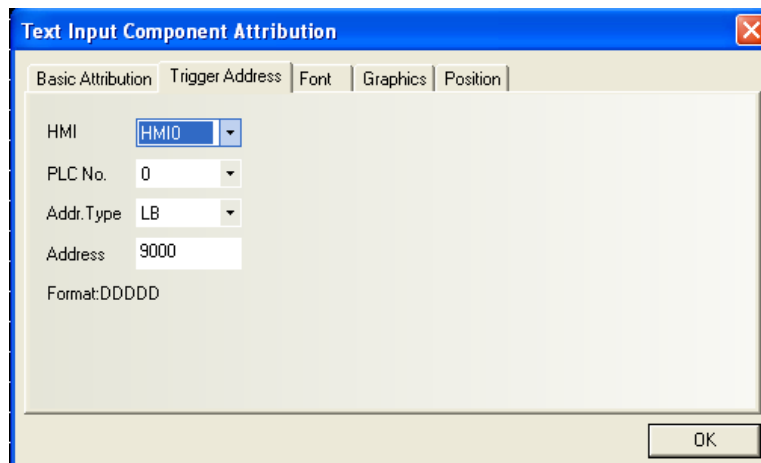

The project wizard has a default numeric keyboard on window 3 for numeric value input. On Window 1, which is the default common window, there are two direct window components. They will popup window 3 when there is a touch event on numeric/text input component. To use a customized keyboard other than the default window 3, please delete the two direct window components. If you want all the numeric/text input components to use the same keyboard, put the direct window component on Common window 1 and make the DW part call the customized keyboard window. If you want the input components on different windows to have their own keyboard, put DW part on the window where the input component is.

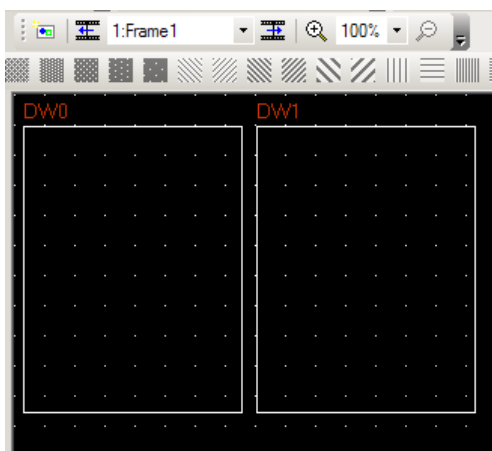

The two DW parts on window 1. They will popup default window 3 when an input component is pressed. Delete them if you want to use customized keyboard.

2. Compute the size of the keyboard. In this example, we will create a keyboard with 10 digit keys, all 26 letter keys and four function keys: Clear, Backspace, Esc and Enter. The keyboard has four lines with 10 keys on each line. We set the size of one key to be 25×25 , the size of the whole keyboard is 250×100 . For displaying the content just input, add a line 250 pixels wide and 25 pixels high. So the complete keyboard is 250 pixels wide and 125 pixels high. In this example, we use window 4 as the keyboard window. Use the window attribution dialogbox to change the size of the window to 250×100 .

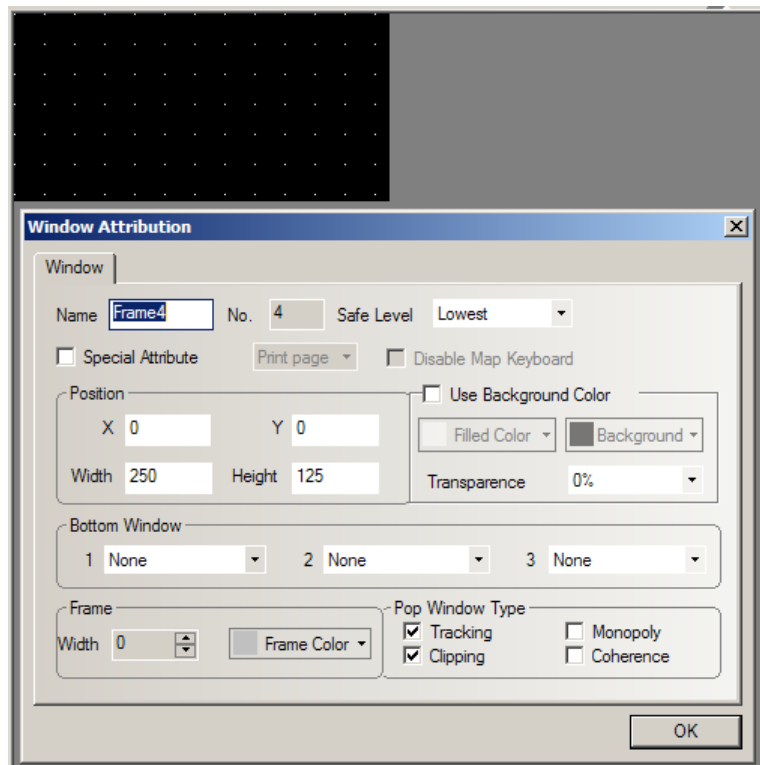

Add function keys on window 4 and designate the ASCII code for the key. In the following figure, we put a function key and configure it for inputting “a” (for details about function key, refer to section 6.?)

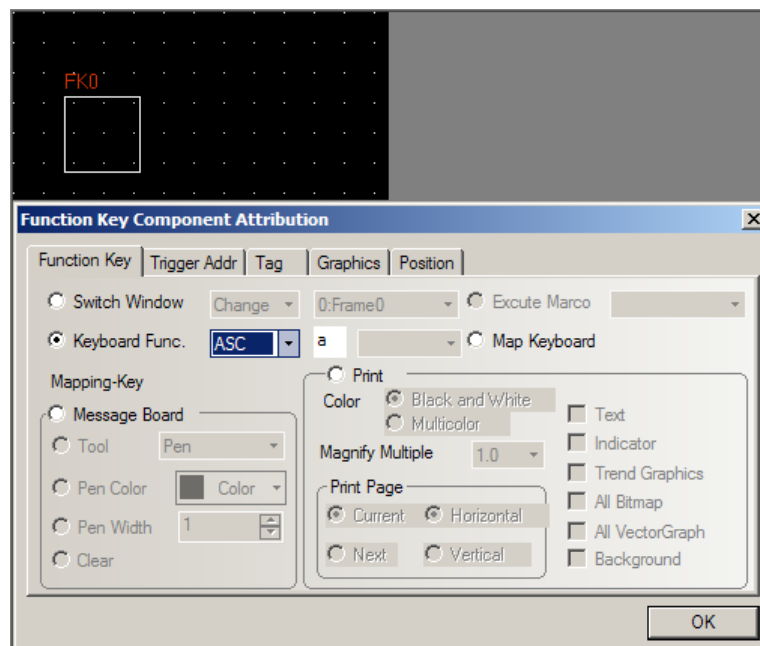

Go to the **[Tag]** tab, set the tag for the key as “a”. Go to **[Graphics]** tab and select a graphic for the key. Go to the **[Position]** tab, set the size of the key to 25×25:

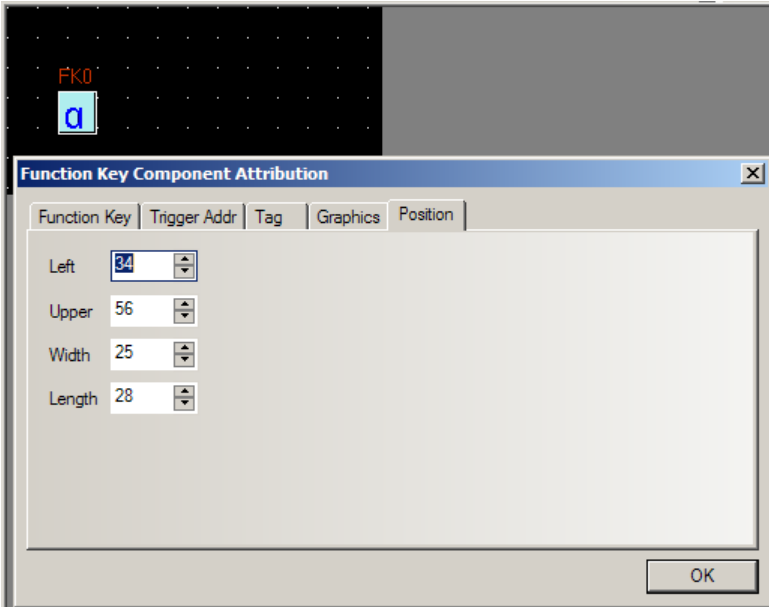

Add other function keys in the same way, adjust their position to line them up.

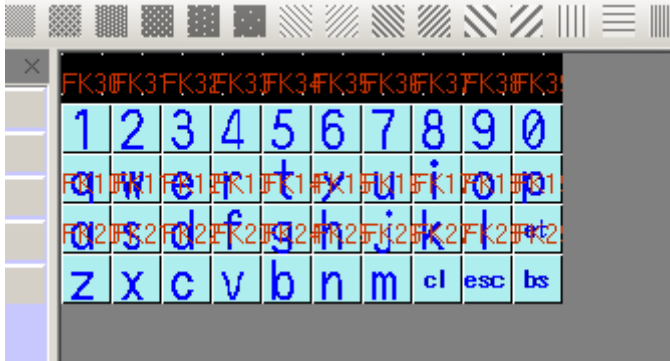

Add a text display component, according to the above description of the register LW9060-LW9075, if the font alignment mode for the text display component is set to **Align Right**, the data starts from the highest word, that is, LW9075. Since the text input component covers 5 words, the input address of the text display component is LW9071. (LW9071 to LW9075 are used for saving the content the user has just input,) Goto the Font tab and set the alignment mode as **Align Right**

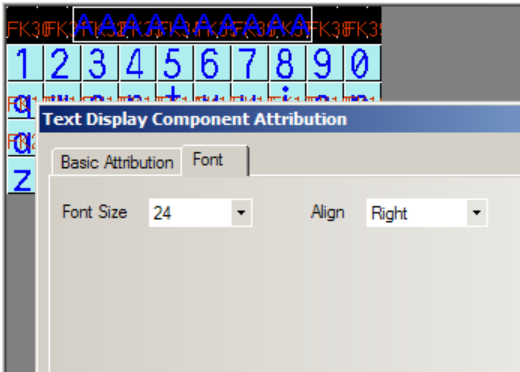
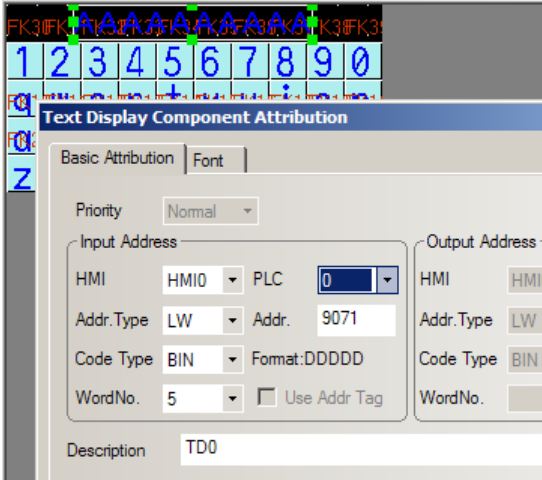

3. Add a direct window component on window 0. The input address is LB9068 (see chapter 11 for details). Go to the **[direct window]** tab to designate window 4 for this component. Go to the **[Position]** tab, set the size of the DW component the same as that of window 4, 250×125.

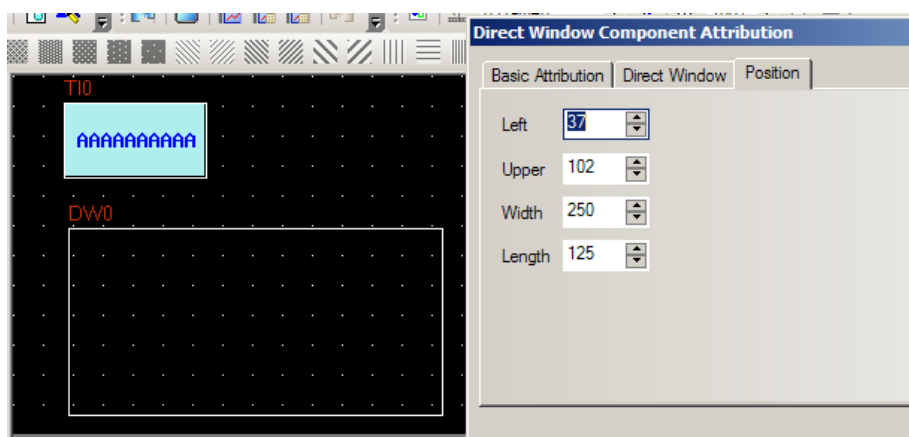
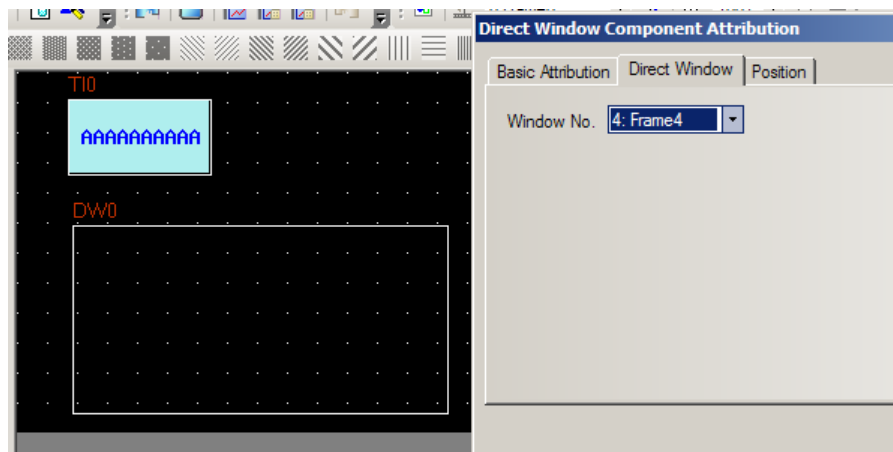
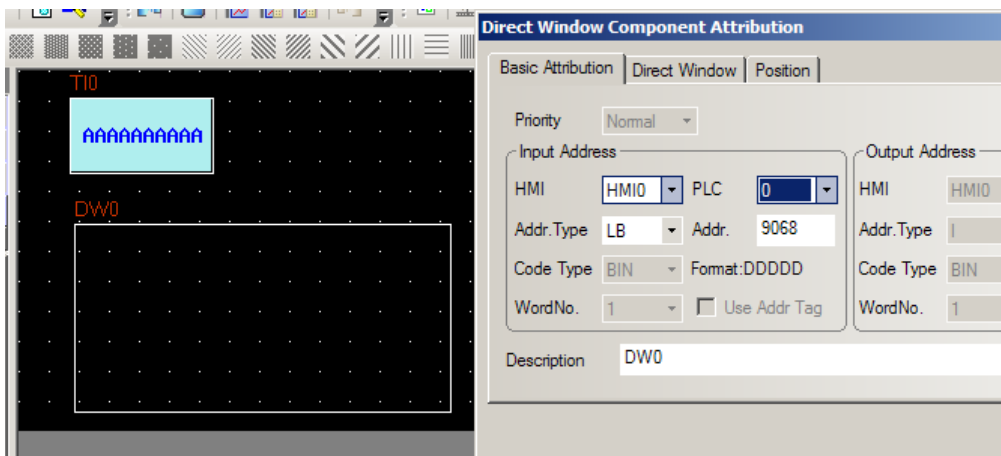

4. Save the project and compile it, Perform the off line simulation. The effect of the project is shown in the following figure:

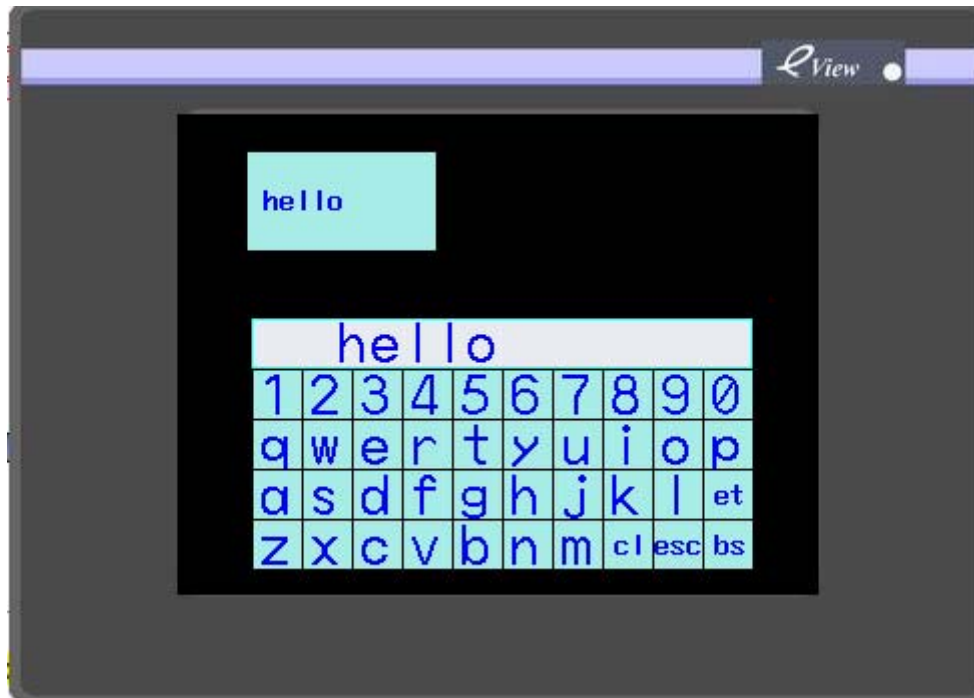

6.13 Text Display



A Text Display component displays the current value of the PLC register data. The data is decoded by standard ASCII character table. The ASCII code stored in the lower byte is displayed on the left and the one stored in the higher byte is displayed on the right.

► Adding a Text Display

1. Click the text display component icon and drag it to the window, the basic attribution tab of the component attributions dialogbox appears.

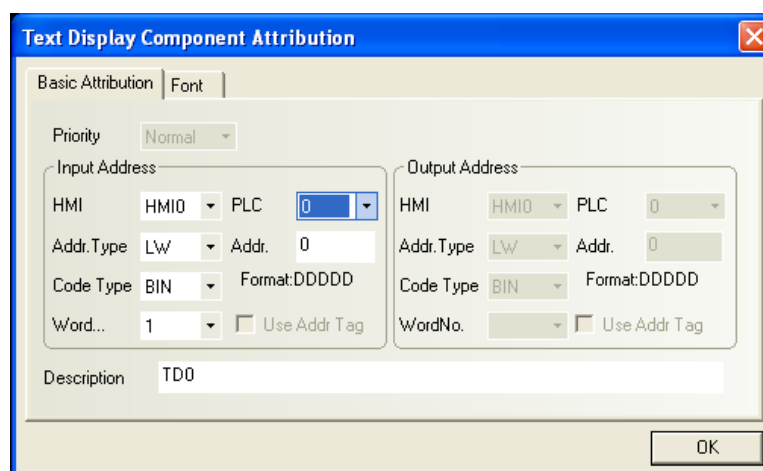

Priority: Reserved function, not used for the time being.

Input Address: The address of the PLC word registers to be displayed (a maximum of 16

words with each word containing two ASCII characters).

Address: The initial address of the word registers corresponding to the text display component.

Code Type: BIN or BCD.

No. of Words: 1 ~ 16 optional for input address.

Use Address Tag: Whether to use the address entered in the address tag library. For details, refer to Section 6.34.

Description: A reference name (not displayed) that you assign to the text display component.

- Go to the **Font** tab: Set the size, color, and alignment mode of display texts.

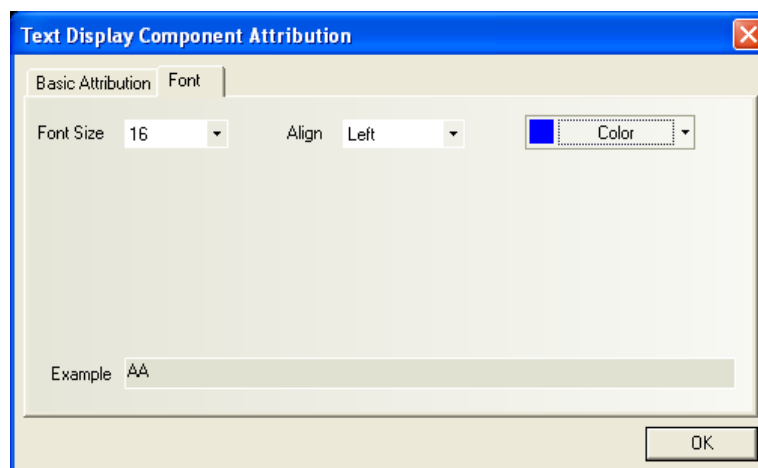

- Click OK to complete the setting and place the text display component in an appropriate position.

6.14 Bar Graph



The Bar Graph displays the PLC register data as a bar graph in proportion to its value as defined by the maximum value and minimum value settings.

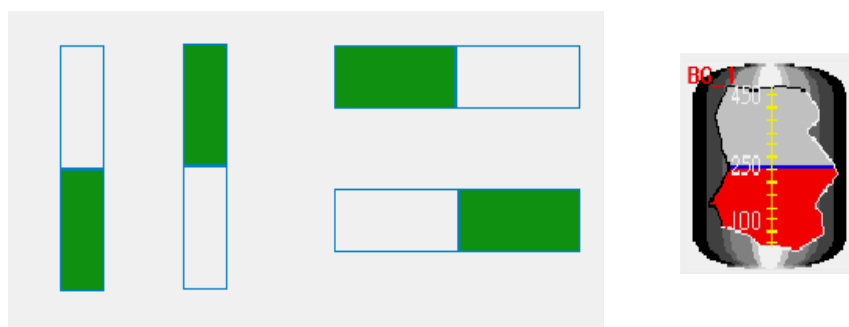

As shown in the figures below, the user can customize bar graphs of any shapes.

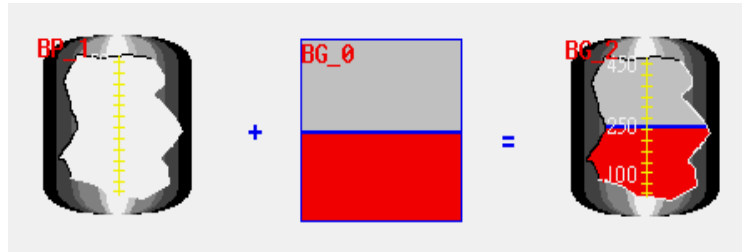

► Adding a Bar Graph

1. Click the bar graph component icon and drag it to the window, the basic attribution tab of the component attribution dialogbox appears.

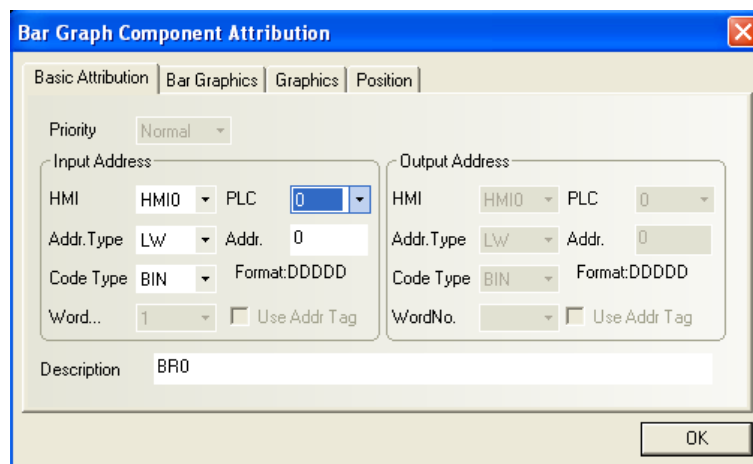

Priority: Reserved function, not used for the time being.

Input Address: The initial address of the word address corresponding to the bar graph.

Code Type: BIN or BCD.

No. of Words: Restricted to 1 or 3. Set to 1 when the variable alarm is disabled. Set to 3 when the variable alarm is selected. For 3 words condition, the Bar Graph component will receive three continuous data words, one for data and two for upper and lower alarm limits.

Use Address Tag: Whether to use the address entered in the address tag library. For details, refer to Section 6.34.

Description: A reference name (not displayed) that you assign to the bar graph component.

2. Go to the **Bar Graph** tab: Set the parameter as shown in the figure below:

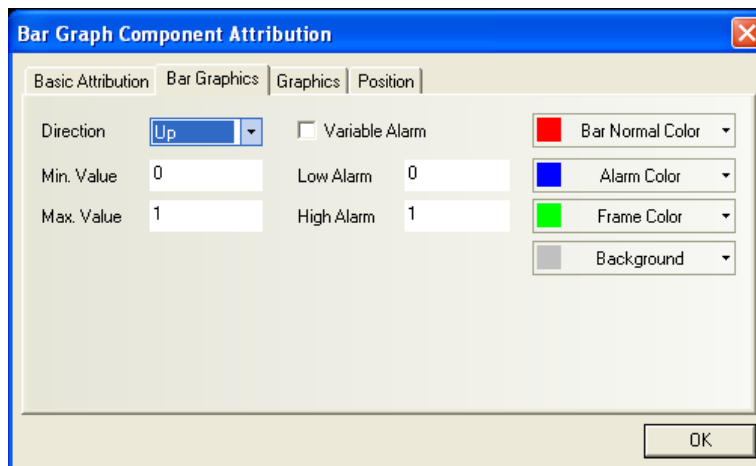

Direction: Up, Down, Left and Right, indicating the direction of the bar movement.

Variable Alarm: If this check box is selected, the upper and lower alarm limits will be obtained from the PLC register described later in this section, and the values for such limits are changeable. If this check box is not selected, the upper and lower alarm limits depend on the values set in the **Upper Alarm Limit** and **Lower Alarm Limit** text boxes in the figure. If the value of the **Input Address** is between the upper and lower limits, the bar graph will not generate an alarm; otherwise, it will generate an alarm. The color will vary with the settings of the **Alarm Color**. Thus the user can use different colors for normal data and data exceed alarm limits.

Variable Alarm	Checked	Unchecked
Read Address	Bar graph data	Bar graph data
Read Address +1	Lower alarm limit	--
Read Address +2	Upper alarm limit	--

Maximum Value/Minimum Value: Set the corresponding maximum value and minimum value for the bar graph.

Upper Alarm Limit/Lower Alarm Limit: If the **Variable Alarm** check box is not selected, these two text boxes are valid. Under this condition, the panel use the two panel registers instead of two PLC registers to store the alarm limits.

Color: Set bar color (for normal value), bar color (for values exceed alarm limits), background color and frame color.

3. Go to the Graphics tab: Select vectogram or bitmap to enhance display effect.

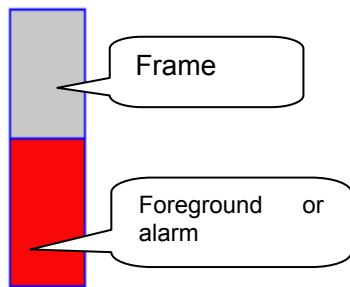

The filled bar percentage is calculated as follows:
Percentage of filled bar =

$$\frac{(\text{Reading value} - \text{Min. value}) \times 100\%}{(\text{Max. value} - \text{Min. value})}$$

- Click OK and adjust the position and size of the bar graph component.

6.15 Meter



The Meter displays PLC register data as an angular indicator in proportion to its value as defined by the maximum value and minimum value setting.

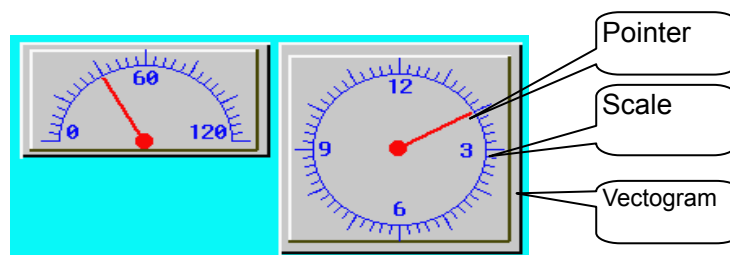

A traditional meter may be composed of three parts

► Procedure to add a Meter

- Click the meter component icon and drag it to the window, the basic attribution tab of the component attribution dialogbox appears.

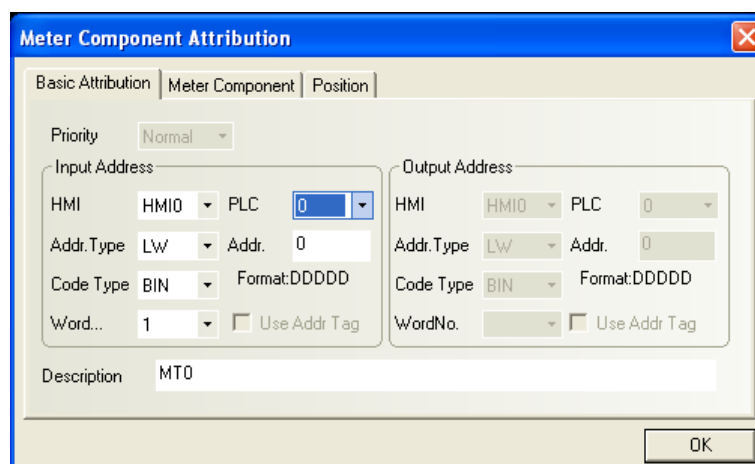

Priority: Reserved function, not used for the time being.

HMI: If your project contains two or more HMIs, select which HMI it belongs to in this list. In this way, you can directly operate the local address or the address of the connected PLC of

any HMI in the same project.

Input Address: The PLC word register address of the value displayed by the component.

[PLC]: Select a PLC. If this HMI is connected with more than one PLC, select the PLC corresponding to the input address.

Address Type: Select the address type corresponding to the meter, that is, the monitored address type. The address type varies with PLC type. Alternatively, you can also use the internal address type of the HMI panel. For internal address types of HMI, refer to Section 5.4. Please note that some internal addresses of the HMI are used by the system. Do not use these addresses. For details, refer to Chapter 11.

Address: The initial address of the word registers corresponding to the meter.

Code Type: BIN or BCD.

No. of Words: Select 1 or 2 for input address.

Use Address Tag: Whether to use the address entered in the address tag library. For details, refer to Section 6.34.

Description: A reference name (not displayed) that you assign to the meter component.

- Go to the **Meter Component** tab:

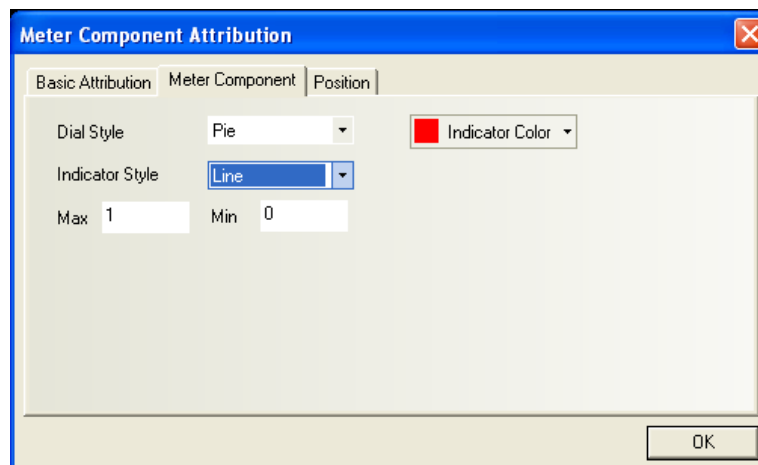

Dial Style: Round (Pointer up, pointer down), sector(Pie)

Max. Value/Min. Value: Set the maximum value and minimum value to be displayed by the meter component.

Pointer: Line shape or diamond shape.

The following figure shows the effect of the meter with a line pointer and a diamond pointer (working with dial component):



Pointer Color: Select the color of the pointer.

Dial style: Sector, round (Pointer up), round (Pointer down)

The following figure shows three types of dials (scale component must be used with meter):

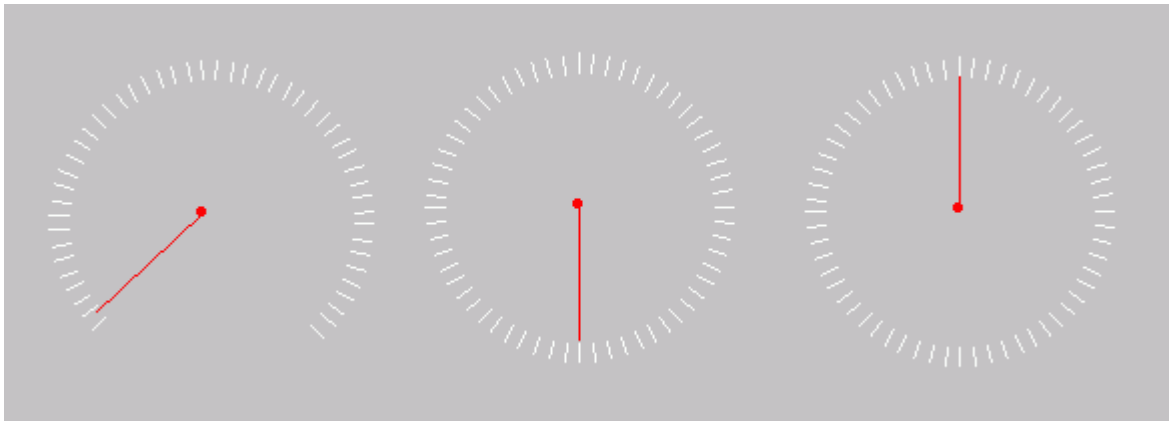

Note: In general, a point has to work with the scale component. The scale can be used to strengthen the operation effect of the pointer. Refer to the description of scale later in this document.

3. Click OK and adjust the position and size of the meter component.

6.16 Indirect Window



The Indirect Window component pops up a registered window over the current screen. Refer to section 4.3 for the creation of a new window. Usually the size of windows invoked by an indirect window component is made smaller than full screen size (or equal to the full screen size). The Indirect Window component calls up a window that is specified by a word register specified by the **Input Address**. There is no absolute limitation to the maximum registered Indirect Windows components in the EV5000. However, at run time, only 16 windows at the most can be displayed simultaneously. To close an indirect window, change the value of the **Input Address** register to 0.

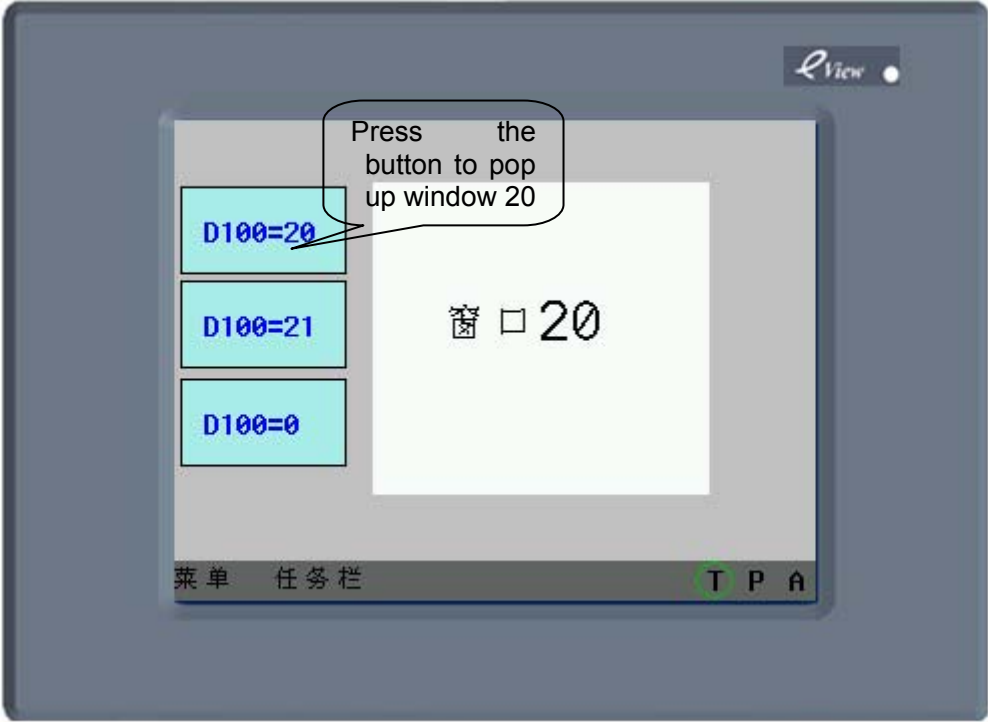
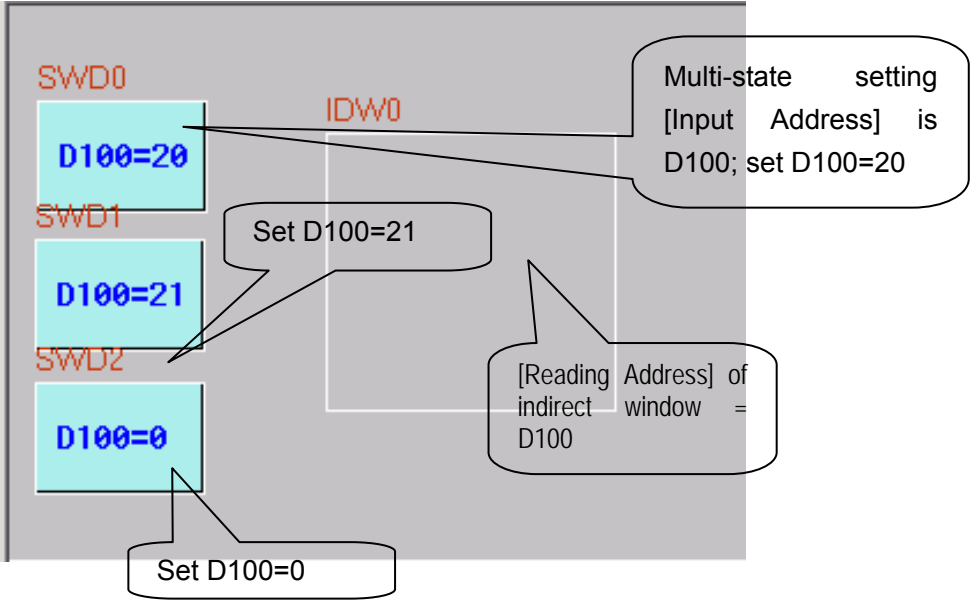

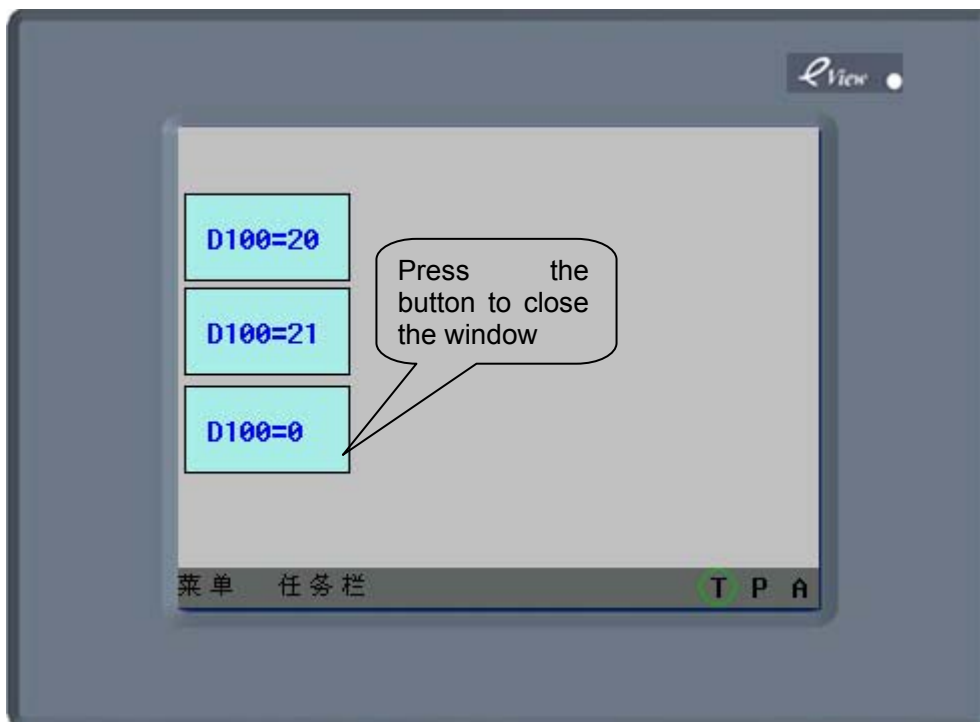
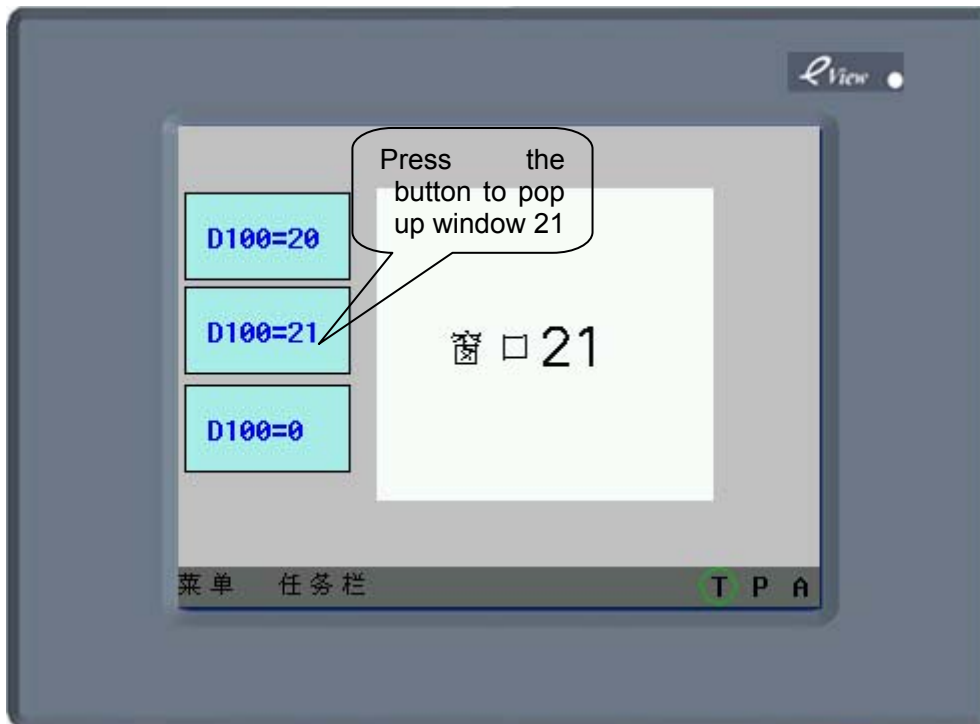

► Adding an Indirect Window

1. Click the indirect window component icon and drag it to the window, the Basic Attribution tab of the component attribution dialogbox appears.

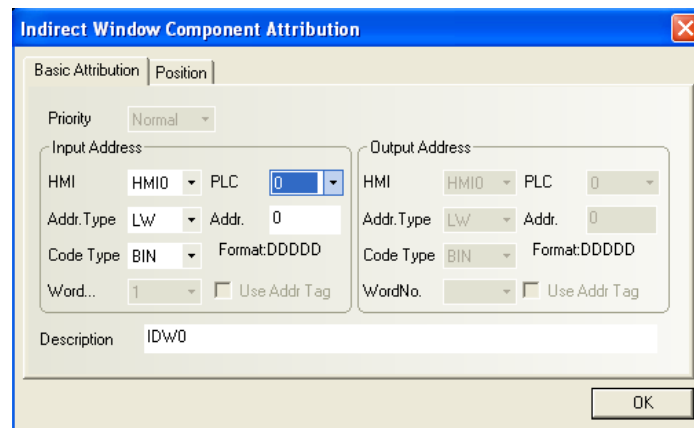

Priority: Reserved function, not used for the time being.

Input Address: The address of PLC word register designated to store direct window No. When the register value changes, the window designated by the changed value will pop up. For example, if the value changes to 20, window 20 will appear (the window must be created). If the value changes to 0, the window closes.

Address: The word register address corresponding to the indirect window.

Code Type: BIN or BCD.

No. of Words: The default value is 1 for input address.

Use Address Label: Whether to use the address entered in the address label. For details, refer to Section 6.34.

Description: A reference name (not displayed) that you assign to the indirect window component.

2. Click OK and adjust the position and size of the indirect window component.

The size of the Indirect Window limits the area of pop-up window. The area of pop-up window out of the Indirect Window boundary will be truncated. The Function Key can be assigned to the window to enable repositioning and minimizing features. (Refer to **Window Bar** and **Minimize Window** in the Function Key Component Section.)

Pop-up method for direct and indirect window: The window is controlled by a PLC bit (Direct Window) or word (Indirect Window) address. Once the bit or word address is activated, the window pops up. When the bit or word changes to 0, the window closes.

Taskbar : If a pop-up window has such function keys as **Window Bar** and **Minimize Window**, whenever a window is popped up, an icon will appear on taskbar to represent the window. Clicking the window icon on the taskbar will put the corresponding window on the top layer of the screen. Double click the window's icon will minimize the window, and click again will restore the window.

6.17 Direct Window



The **Direct Window** component places a registered window over the current screen. The pop-up window is displayed in the area of Direct Window component outline. Usually the size of Direct Window is set the same as those of pop-up window. There is no absolute limitation for the maximum number of Direct Window. However at run time, up to 16 windows can be displayed simultaneously at a time. A Direct Window can only be open or closed by the bit register specified by the **Reading Address**. The function key cannot be used to close the window. A Direct Window pops up when the bit register is turned ON and the window closes when the bit register is turned OFF.

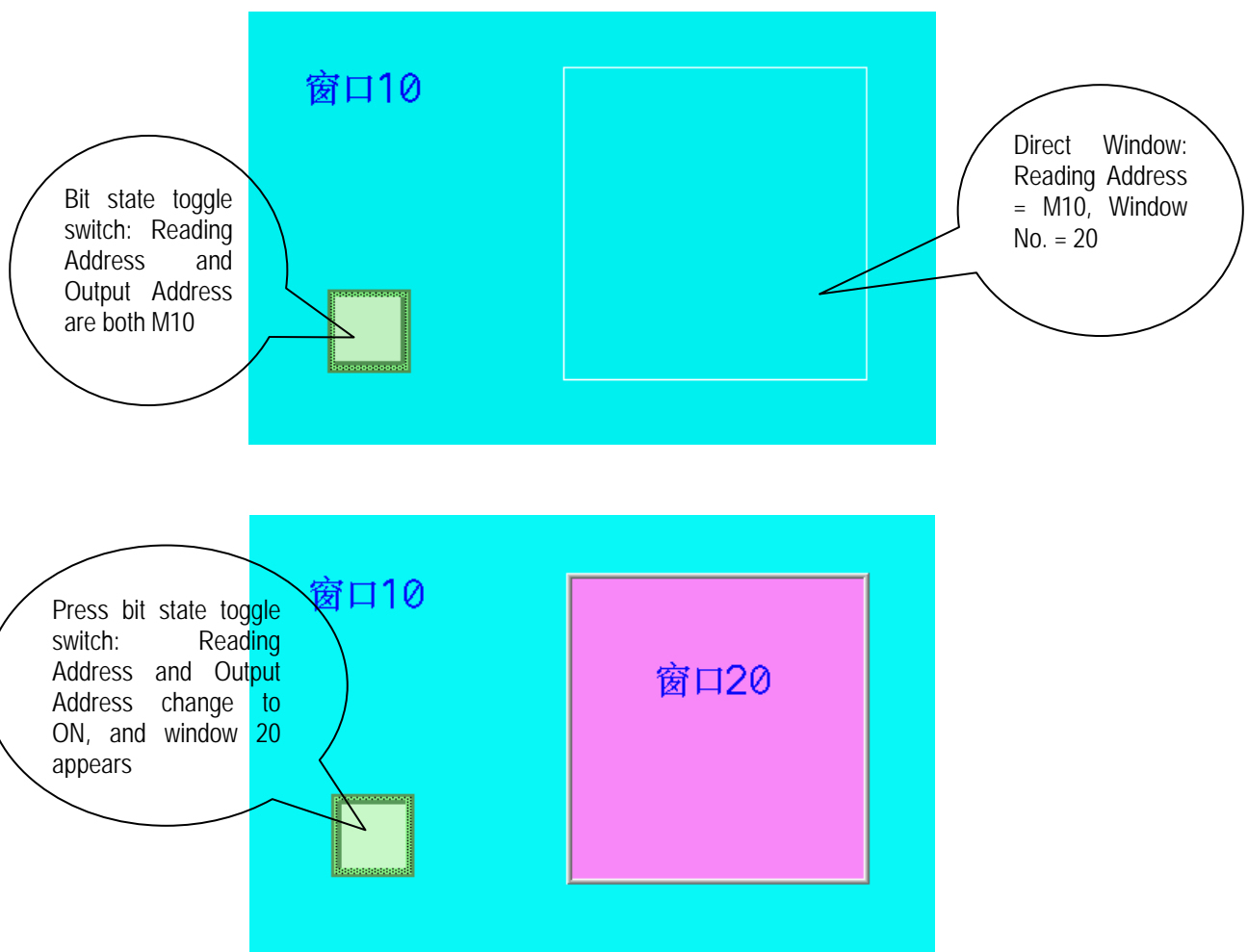

► Adding a Direct Window

1. Click the direct window icon and drag it to the window, the basic attribution tab of the component attribution dialogbox appears.

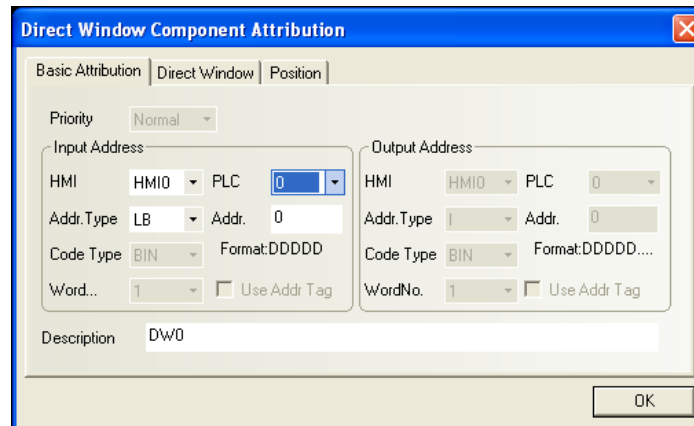

Priority: Reserved function, not used for the time being.

input Address: Bit in the PLC that activates the direct window.

Address: The bit address corresponding to the direct window component.

Use Address Tag: Whether to use the address entered in the address tag library. For details, refer to Section 6.34.

Description: A reference name (not displayed) that you assign to the direct window component.

2. Go to the **Direct window** tab and select a target window number in the **Window No.** drop-down list box.

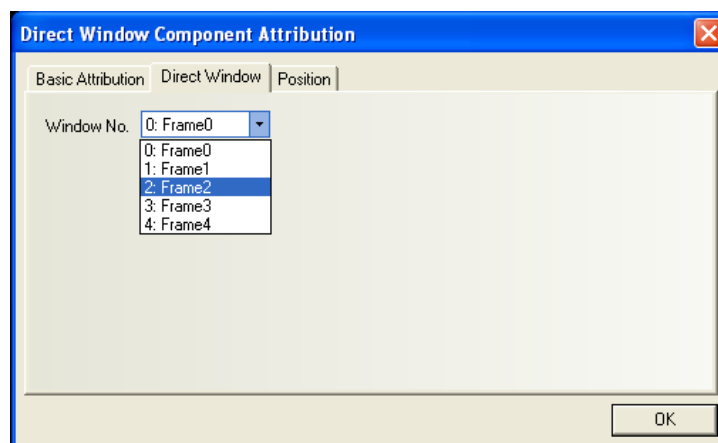

3. Click OK and adjust the position and size of the direct window component. The size of the window limits the area of display. The area of pop-up window out of the direct window boundary will not be displayed. Function Key can be assigned to the window to enable repositioning and minimizing features. Refer to **(Window Bar)** and **(Minimize Window)** in the Function Key.

6.18 Alarm Information Logon

Messages to be displayed on the Alarm Display component must be registered in the Alarm Entry list (Alarm information logon). Each message corresponds to a PLC bit register. If the PLC bit

device activates (either ON or OFF), the corresponding message is displayed on the Alarm Display. (This component is only used to enter alarm messages. To display alarm messages, the Alarm Display component is required.)

► Procedure to add/modify alarm entry message

1. Click the  icon (in the database toolbar), the alarm message object library will pop up, or enter the alarm message entry page in the “**Library**” menu in the menu bar.

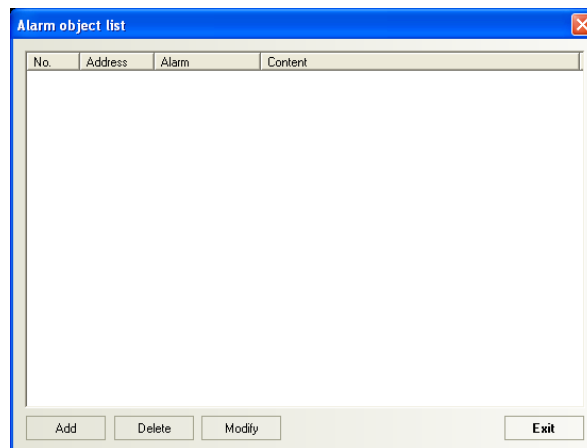

2. Click the **Add** button to add message or click the **Modify** button to modify an existing message.

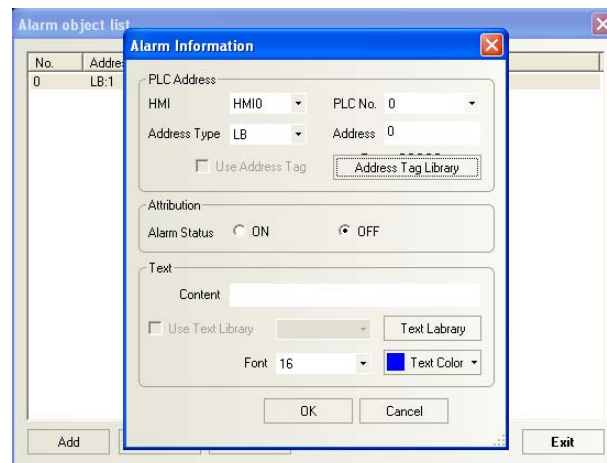

PLC Address: Designate the PLC bit address to trigger the message.

Attribute:

Alarm-ON: Displays alarm message when bit is ON.

Alarm-OFF: Displays alarm message when bit is OFF.

Content: Enter the message content and color, and the default font size for messages is 16.

3. Click OK and the alarm message will be displayed in the **Alarm List**. After entering alarm message, you can edit existing message through the **Delete** and **Modify** button. Click **Exit** to exit alarm entry.

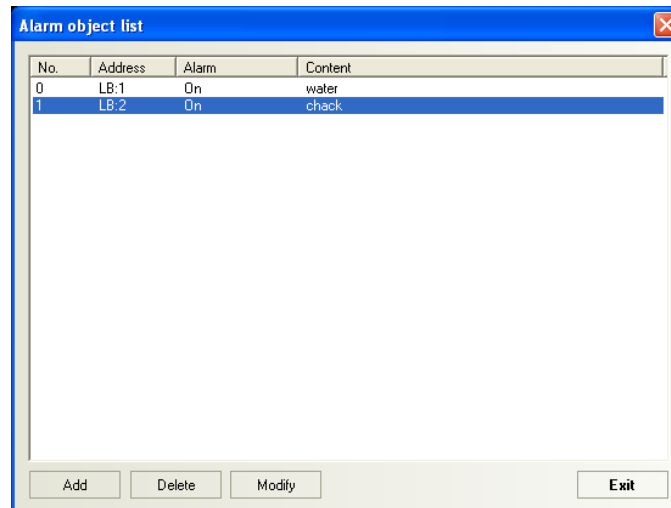

In order to improve the communication efficiency, it is recommended that a block of continuous PLC bit registers be used for the alarm list. For example: Use M100~199 to control the display of all messages. In this case, one read command reads M100~199 all at once instead of one bit at a time.

6.19 Alarm Display



The **Alarm Display** component will display all triggered alarm messages in a designated area. The content displayed is the same as that displayed on the alarm bar. All alarm messages are related to specific bit registers. When an alarm message is generated, the alarm will be removed only after the corresponding bit register switches back to normal state; otherwise, the alarm message will always be displayed, that is, the alarm state remains ON. (This component is only used to display alarm message. Messages must be entered with the **Alarm Information Logon** component before display.)

► Adding alarm display

1. Click the Alarm Display component icon and drag it to the window, the basic attribution tab of the component attribution dialogbox appears.

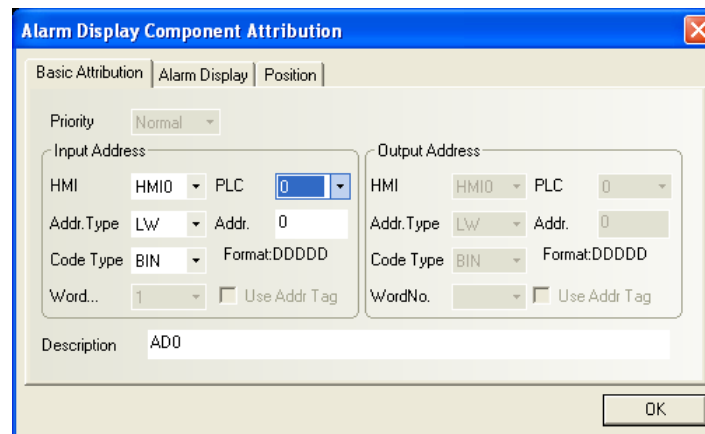

Priority: Reserved function, not used for the time being.

Input Address: The **Input Address** controls the scrolling (up and down) of the alarm display window. All active alarm messages are sorted by time, the new alarms are displayed on top and the older ones are put on the bottom. If the register value is N, then the top N-1 messages will be ignored and the number N message of the order of arrival is placed on the first line of the display window.

Address: The word address corresponding to the alarm display component.

Code Type: BIN or BCD.

No. of Words: The default value is 1 for input address. Not editable.

Use Address Tag: Whether to use the address entered in the address tag library. For details, refer to Section 6.34.

Description: A reference name (not displayed) that you assign to the alarm display component.

2. Go to the **Alarm Browse** tab, as shown in the figure below:

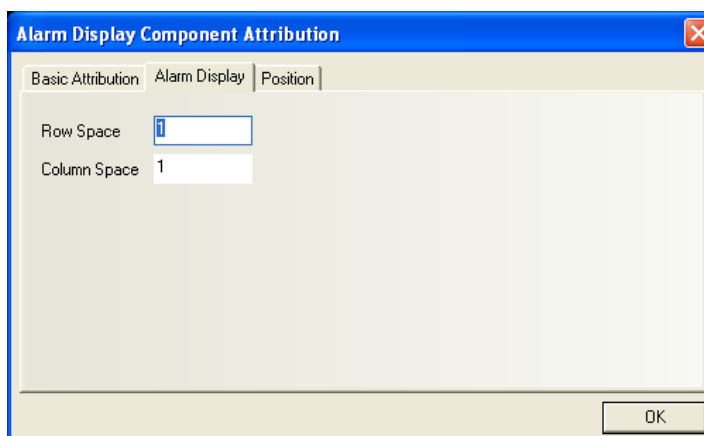

Row Spacing/Column Spacing: The spacing between different rows or columns.

3. Click **OK** and adjust the position and size of the alarm display component.

◆ Example of an Alarm Display

A vectogram (SP_0) is used for the background rectangle. The vectogram SP_1 indicates a sunken display area. Two word setting components (SWD_6, SWD_7) are used to increase and decrease the starting lines of the displayed alarm message (control the increase or decrease of the **Input Address** value). The actual **Alarm Display** component (AL_0) is placed on top of the vectogram. The alarm messages appear in the **Alarm Display** when the system runs. The effect diagram is shown as follows:

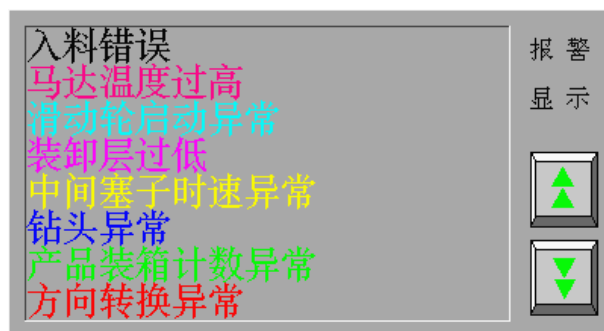

6.20 Trend Curve



The **Trend Curve** periodically retrieves a block of PLC data and displays the trend data over time. As each sampling period elapses, the new data is read from the PLC and inserted towards the right side of the trend graph. The trend graph is retrieved on a real time basis.

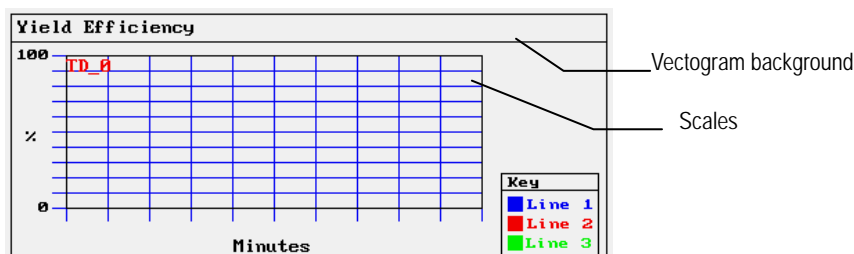

Trend Graph

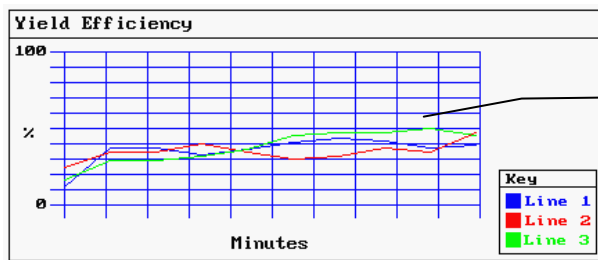

The newest data is inserted into the left side and the track is shifted right

An example of a typical trend curve is shown as the above. A vectogram is used for the background and scales are added to show relative information about the trend. The trend graph is then placed on top of the vectogram.

► Procedure to add trend curve

1. Click the **Trend Curve** component icon and drag it to the window, the basic attribution tab of the component attribution dialogbox appears.

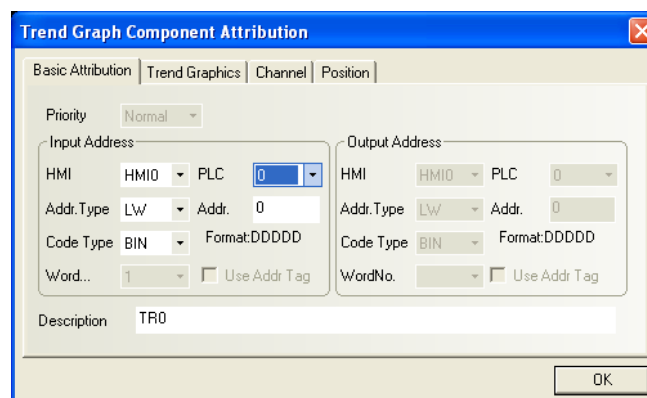

Priority: Reserved function, not used for the time being.

Input Address: Specify the PLC word register of the first trend curve, the second trend curve corresponds to register at **read address + 1**, and the third curve corresponds to register at **read address + 2**, etc

Address: The initial address of the word register corresponding to the trend curve component.

Code Type: BIN or BCD.

No. of Words: Depend on the number of sampling channels. If the number of channels is N ($1 \leq N \leq 16$), the No. of words is N.

Use Address Tag: Whether to use the address entered in the address tag library. For details, refer to Section 6.34.

Description: A reference name (not displayed) that you assign to the trend curve component.

- Go to the **Trend Graphics** tab to set related parameters.

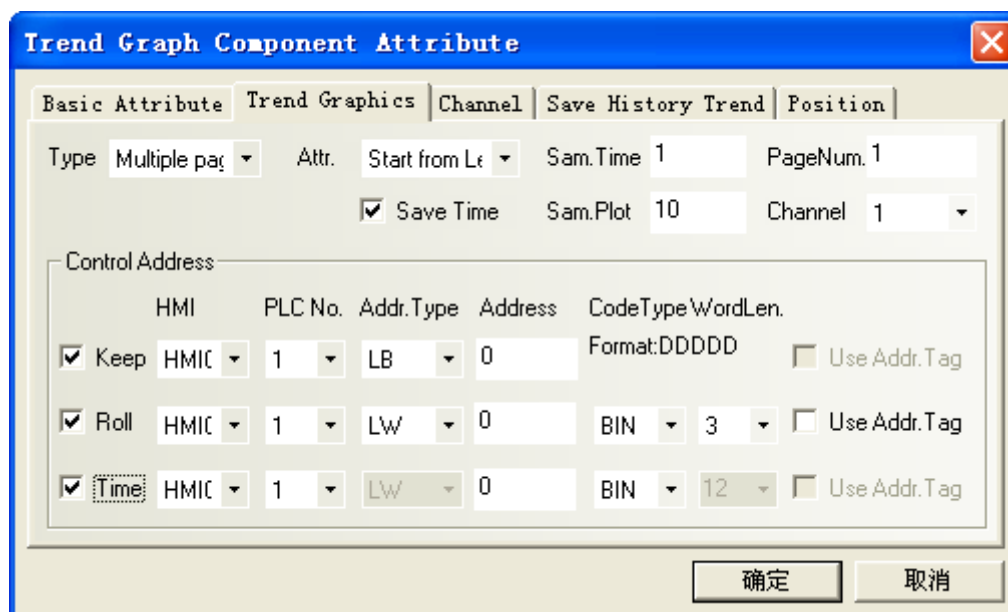

Type: Single page or multiple pages.

If the user selects the single page display mode, it will only display the data change of the sampling values in the current page. It does not allow the extension of the trend graph. If the user selects multiple-page display, it allows the extension of the trend graph. Data is displayed in the same way, but when the trend graph rolls forward, the previous sampling data will not be lost. Historical data will be saved to the memory for future reference. Please note that a maximum of 31 pages of historical data are available, which is determined by the **No. of pages** parameter.

Attribute: Start from left or start from right. In other words, it determines whether the graph is displayed from the left to right or from the right to left when displaying the sampling data.

Sampling Time: Time interval between two sampling points, in seconds.

No. of Sampling Points: Number of sampling points displayed for one curve.

No. of Pages: When the **Type** is set to **"Multiple Pages"**, this box is available.

Channel: Number of tracks to be displayed, corresponding to the number of word registers of the PLC data. One word register corresponds to one track.

Hold(Keep): The bit register that controls the start or stop of the trend graph; in other words, the sampling data stops when the **[Hold]** bit is turned ON, and the sampling continues and trend graph will be dynamically displayed when the **[Hold]** bit is turned OFF again.

Scroll: This address has to be used with the scrolling bar component, that is, the user can view the trend graph by directly moving the scroll bar. Set the scrolling address the same as the address of the scrolling bar component to be associated. For details, refer to "Scroll Bar".

Time: When the **Save Time** check box is selected, the **Time** box in the lower part of the window will be activated. It includes 12 words used to save the time of the latest sampling

point. The 12 words contain the “second, minute, hour, day, month, year” of the start point and the “second, minute, hour, day, month, year” of the end point in the current page. Each word represents a time point.

3. Go to the **Channel** tab and set related parameters of each track.

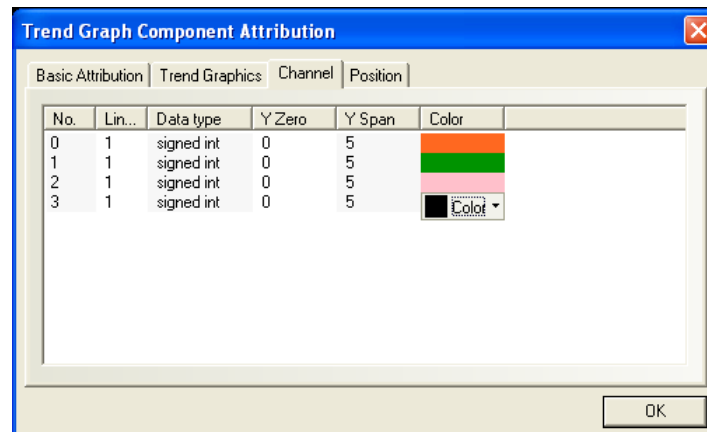

Color: Designate the color of each track.

Line Width: The width of a line, including 8 options.

Data Type: Set the data type, with only two options of signed integer and unsigned integer.



Max. and Min Value in Y Direction (Y zero and Y span): Set the corresponding maximum and minimum values of each track line along the Y direction.

4. Click OK and adjust the position and size of the trend graph component.

◆ Examples of a single-page trend graph and a multi-page trend graph

6.20.1 Single-page Trend Graph

Firstly, create a project and save it.

Add a single-page trend graph component. In the Basic Attribution tab, set **Input Address** to LW0. In the **Trend Graph** tab, set **Sampling Time** to 1 second, **No. of Sampling Points** to 21, and **Channel** to 4, as shown in the figure below:

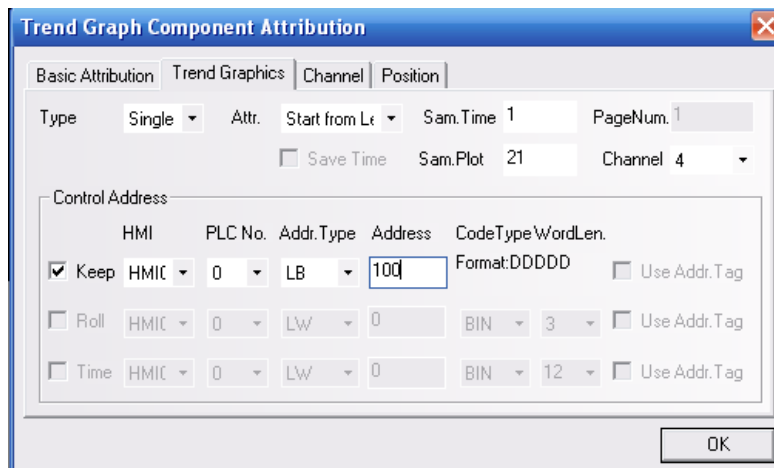

In the **Channel** tab, set the color of four track lines respectively to blue, red, green, and purple. Set the minimum value to 0 and the maximum values respectively to 500, 1000, 1500, and 2000.

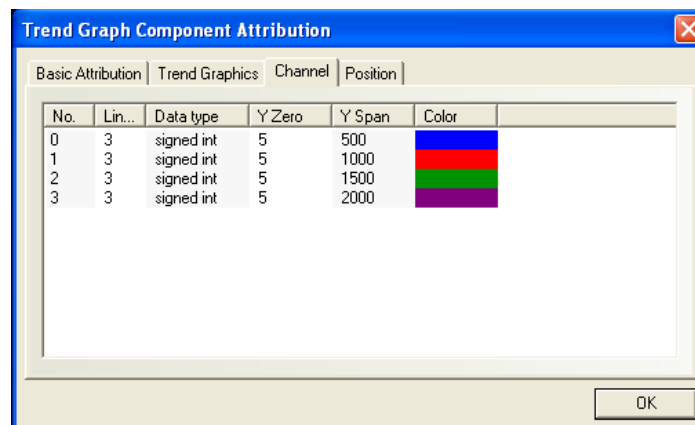

Adjust the size of the trend graph component.

Add two scale components: one is horizontal and the other is vertical, and each is divided into 20 equal scales. Place them together to form a network and place the trend graph component on the top. Please note that the size of these three components (2 scale components and 1 trend graph) must be the same and they must be overlapped with each other, as shown in the figure below:

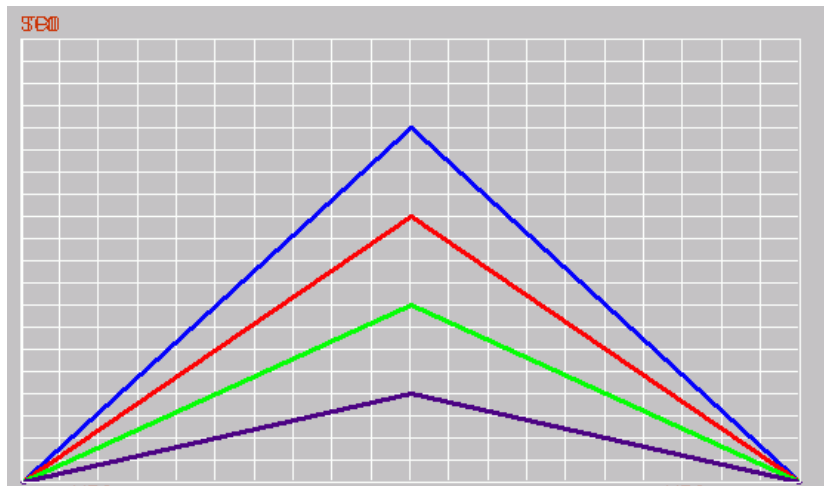

Add four numeric display components to display the values of LW0, LW1, LW2 and LW3 respectively.

Add four timer components to perform periodic circulation for the data of LW0, LW1, LW2 and LW3 respectively. The corresponding minimum value is 0 and corresponding maximum values are 500, 1000, 1500 and 2000 respectively. The step length is 10 and cycle time is 0.5 second. Take data control of LW0 for example, as shown in the figure below: (for details about Timer Component, refer to 6.30)

Timer Component Attribution	
Timer Timer Function	
Basic Attribution	
Trigger Mode	All time
Exe. Cycle(100ms)	30
Response Mode	Immediate
Response State	Off
Repeat Times	0
Trigger Address	
HMI	HM10
PLC No.	0
Address Type	LB
Address	0
OK	

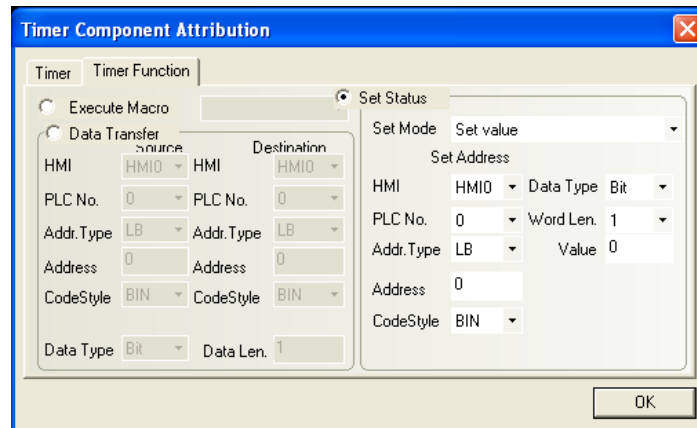

The display effect of window 0 after completing editing is shown as follows:

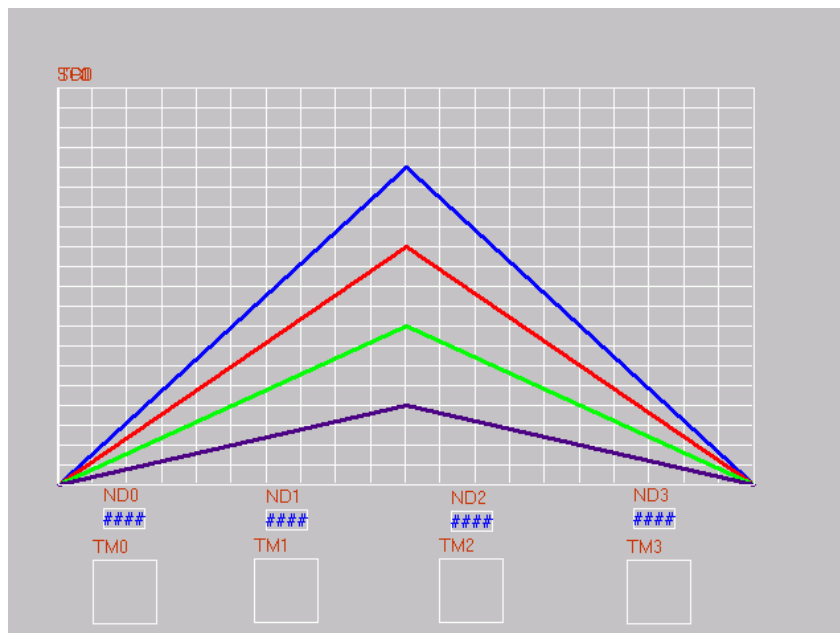

Save and compile it, and then perform offline simulation. The operation effect is shown in the figure below:

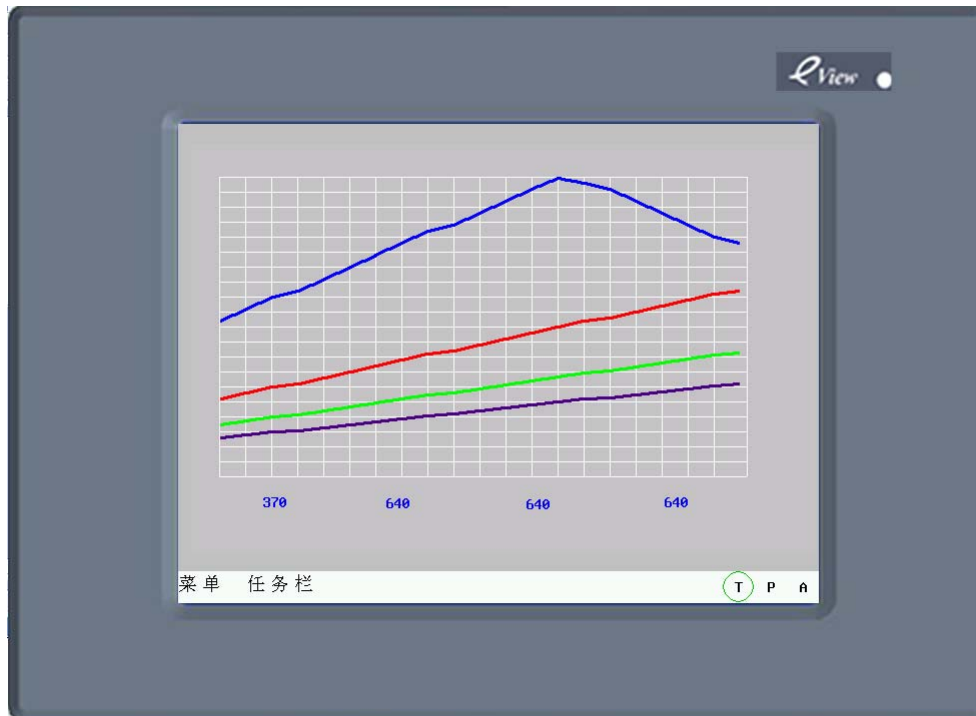

6.20.2 Multi-page Trend Curve

Make the following modifications on the basis of the single-page trend curve shown in the previous example:

In the **Trend Graph** tab, select multiple pages in the **Type** drop-down list box.

Select 15 in the **No. of Pages** drop-down list box. Select the **Save Time** check box. Set the **Hold**, **Scroll** and **Time** register addresses respectively to LB100, LW100 and LW110, as shown in the figure below:

	HMI	PLC No.	Addr. Type	Address	CodeType	WordLen.	
<input checked="" type="checkbox"/> Keep	HMIC	0	LB	100	Format:DDDD		<input type="checkbox"/> Use Addr. Tag
<input checked="" type="checkbox"/> Roll	HMIC	0	LW	100	BIN	3	<input type="checkbox"/> Use Addr. Tag
<input checked="" type="checkbox"/> Time	HMIC	0	LW	110	BIN	12	<input type="checkbox"/> Use Addr. Tag

The settings for the track lines remain unchanged, as shown in the figure below:

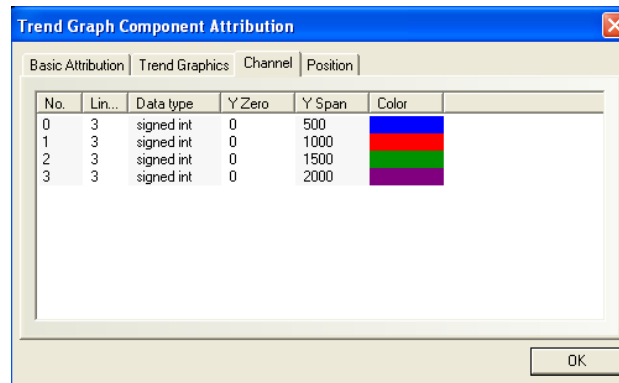

Add two scale components and five vertical lines. One scale component is horizontal and the other is vertical, and each is divided into 20 equal scales. Place them together to form a network and place the trend graph component on the top. Please note that the size of these three components (2 scale components and 1 trend graph) must be the same and they must be overlapped with each other, as shown in the figure below:

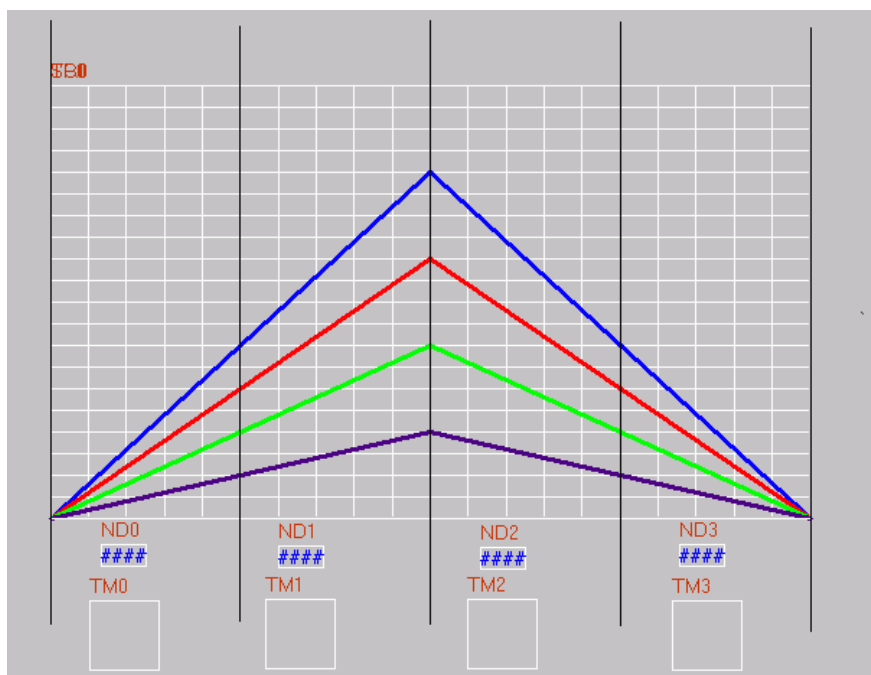

Settings for four timer components remain unchanged.

Add two multi-state setting (word setting) components to control the increase and decrease of LW100 so as to control the page up or page down operation. For the multi-state setting component controlling the value increase, set output address to LW100, set **Setting Mode** to addition, **Added Number** to 5, and the upper limit to a considerable large value. For the multi-state setting component controlling the value decrease, set output address to LW100, set **Setting Mode** to deduction, **Deducted Number** to 5, and the lower limit (Bottom) to 0.

Add a bit state toggle switch to control LB100 so as to control the trend graph whether to pause reading data. The settings are as follows:

Word Control Component Attribution

Basic Attribution | Multi-State Switch | Tag | Graphics | Position

Priority: Normal

Input Address:

HMI: HMIO PLC: 0
Addr. Type: LW Addr.: 0
Code Type: BIN Format: DDDDD
WordNo.: 1 Use Addr Tag

Output Address:

HMI: HMIO PLC: 0
Addr. Type: LW Addr.: 0
Code Type: BIN Format: DDDDD
WordNo.: 1 Use Addr Tag

Description: MSW0

OK

Word Setting Component Attribution

Basic Attribution | Multi-State Setting | Tag | Graphics | Position

SettingMode: Add value

Inc value: 5 Upper Limit: 100

OK

Word Setting Component Attribution

Basic Attribution | Multi-State Setting | Tag | Graphics | Position

SettingMode: Sub value

Dec value: 5 Bottom: 0

OK

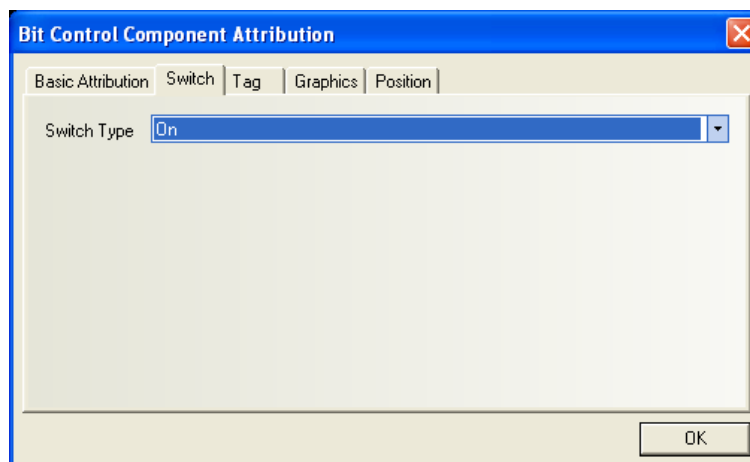
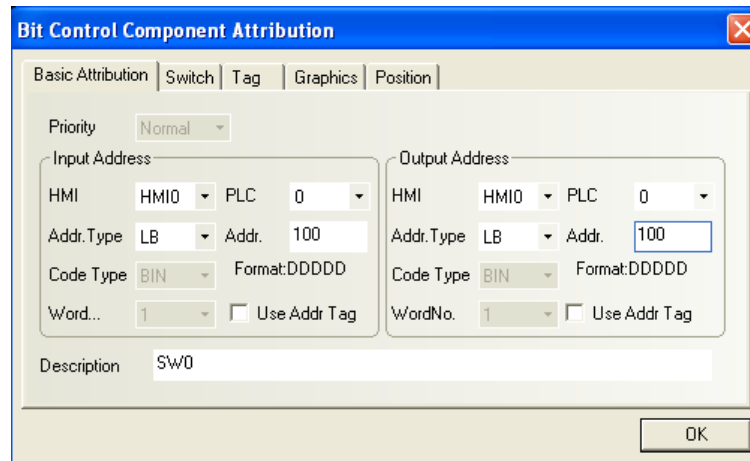

The final display effect of window 4 is shown as follows:

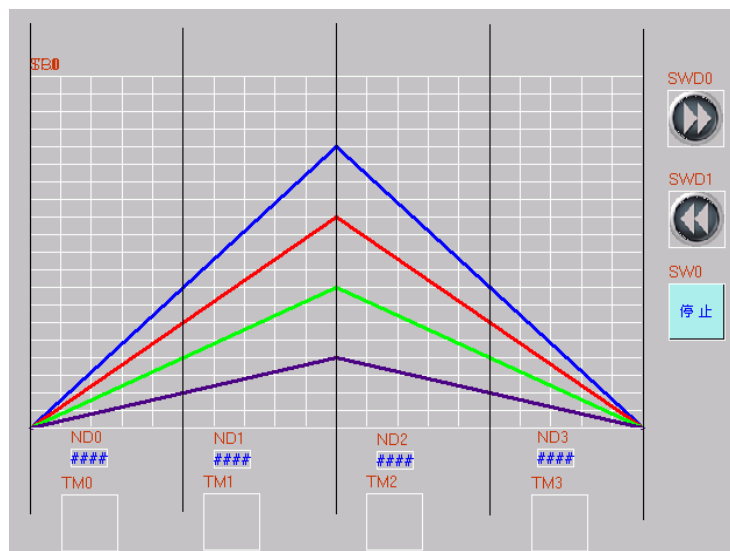

Save and compile it, and then perform offline simulation. The operation effect is shown in the figure below:

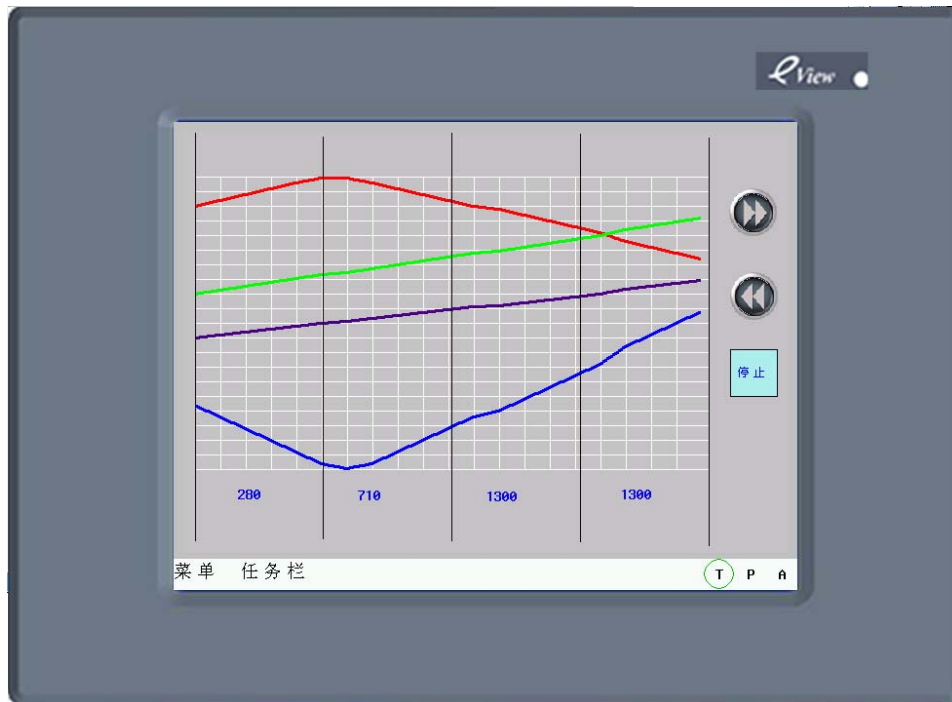

Click **Stop** and the trend graph will hold still. Observe the page turning action. For each page turning operation, the position of the reference coordinate in the leftmost of the trend graph will move the distance of 5 (the inc. value or dec. value in the multi-state setting component) sampling points. There are totally 21 sampling points on the screen, and the 20 equal scales divide the screen into 20 blocks. Each block covers the distance of 2 sampling points.

6.20.3 Time Display

Add six numeric display components, with three placed in the lower-left corner of the trend graph and three in the lower-right corner. They represent the start point time (HH:MM:SS) and end point time (HH:MM:SS) of the coordinate respectively. Where, the addresses for them are respectively LW112, LW111, LW110; LW118, LW117, LW116. Numeric setting components are set as follows:

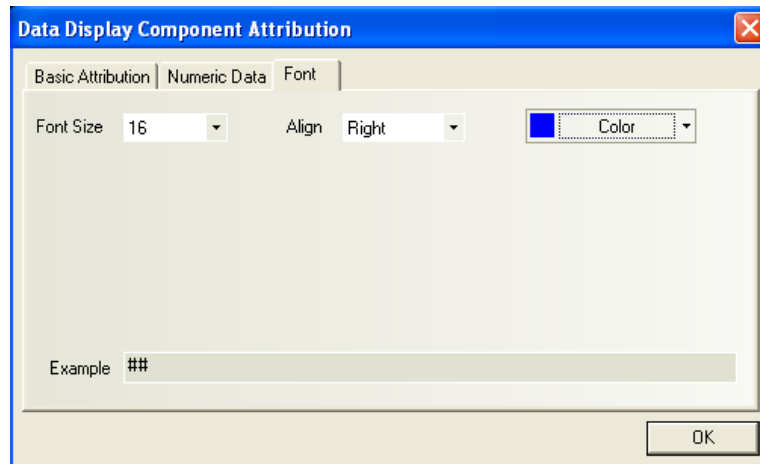

The configuration interface after setting is shown as follows:

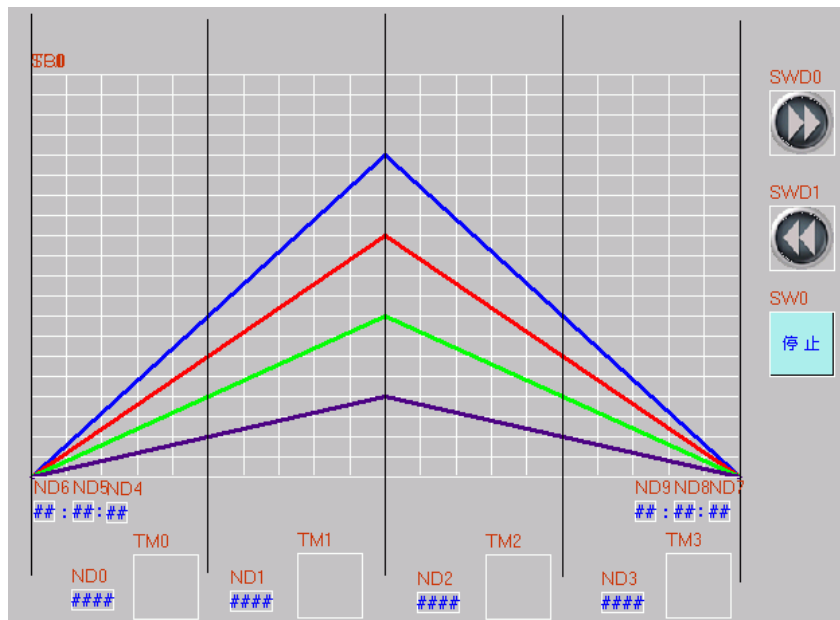

The operation effect is shown as follows:



6.21 Recipe Data



Recipe Data

The **Recipe Data** component can transfer data from the recipe memory of the touch screen to the PLC or from the PLC to the touch screen. For details, refer to Chapter 8.

6.22 Event Entry (Event Information Logon)

When a particular event occurs, a corresponding message will be displayed on the screen if it has been registered in the **Event Entry List** before. The message to be displayed on the **Event Display** component must first be registered in the **Event Entry** list. A PLC bit or word register controls each message. If the PLC bit or word device activates (either by ON/OFF switch or value limit exceeding), the corresponding message is displayed on the **Event Display** component. (This component is only used for event entry. To display an event message, the **Event Display** component is required.)

► Procedure to add/modify event entry message

1. Click the  icon, and the event message object library pops up, or enter the event message entry page in the “**Library**” menu in the menu bar.

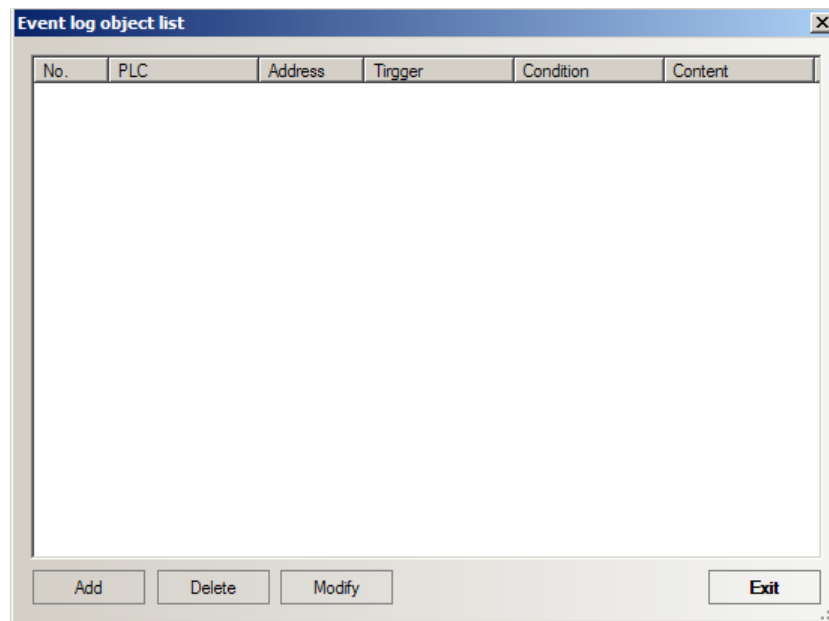

2. Click the **Add** button to add message or click the **Modify** button to modify the existing message.

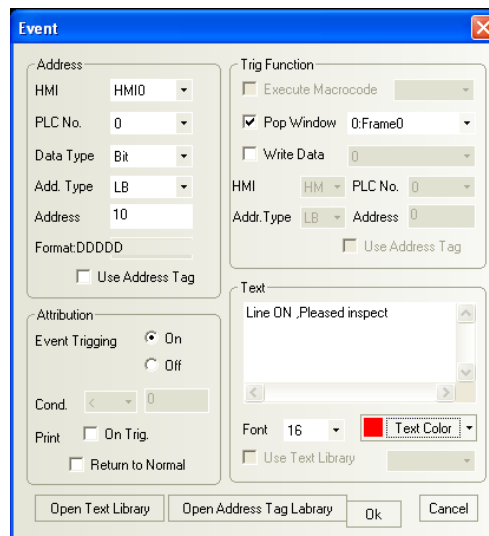

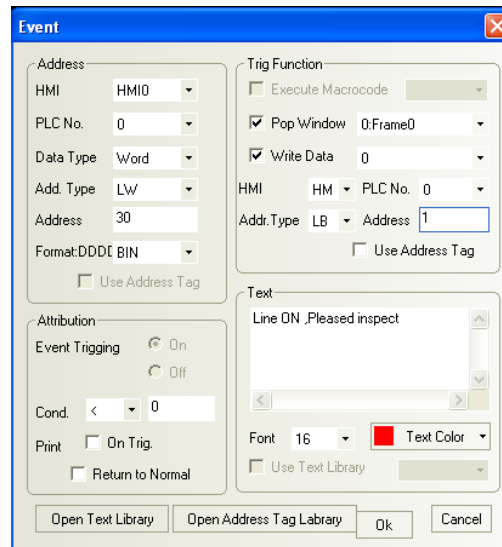
**(1) Address:**

Data Type: Select the node register corresponding to the event as bit or word address.

Address Type: Select the address type of the register corresponding to the event. Address type varies with PLCs.

Address: Designate the PLC bit or word register address to trigger the event.

Code Format: BIN or BCD.

(2) Attribution:**Event Triggering:**

Bits: When **Data Type** is set to “**Bit**”, the attribute can be set as follows:

ON: Displays message when bit is ON. OFF: Displays message when bit is OFF.

Condition

Words: When **Data Type** is set to “**Word**”, the **condition** can be set as follows:

Use “<” to trigger when value in word register is less than preset value. Use “>” to trigger when value in word register is greater than preset value.

Print:

On Trigger: Prints out message when event is triggered.

Return to Normal: Prints out message when the event returns to normal state.

(3) Trigger Function:

Execute Macrocode: If the corresponding event is triggered, it will execute the macrocode set here.

Pop Window: If a registered event is triggered, the corresponding event information will be displayed on the event display area. When the information is acknowledged (pressed on the screen by the operator), the designated window will pop up. To close the pop up window,

place a function key component with the function of closing window.

Write Data: If the corresponding event is triggered, it will write 0 or 1 in the bit address set here, or perform “NOT” operation on the current word value.

Note: The “Trigger Function” is an optional function. If there is no need to use those functions, leave the checkbox unselected.

(4)Text: Enter the content of the event message and select font color and size.

Note: Data from internal memory can be embedded in an event message. To embed a value, use the following format: **%nnd**. Where: “%” is the starting delimiter; “nn” is the internal register (LW) number 00-99; and “d” is the ending delimiter. For example: The content is set as "Current temperature value %25d: UPPER LIMIT ALARM". If LW25 = 120, then the message will be printed out as "Current temperature value 120: UPPER LIMIT ALARM". To print out current value of PLC register data, you should first assign a data transfer component to move data from the PLC to internal memory (LW).

- Click the **OK** key and the event message will be displayed in the Event List. After entering event message, you can edit existing message through the **Delete** and **Modify** button. Press **Exit** to exit event entry.

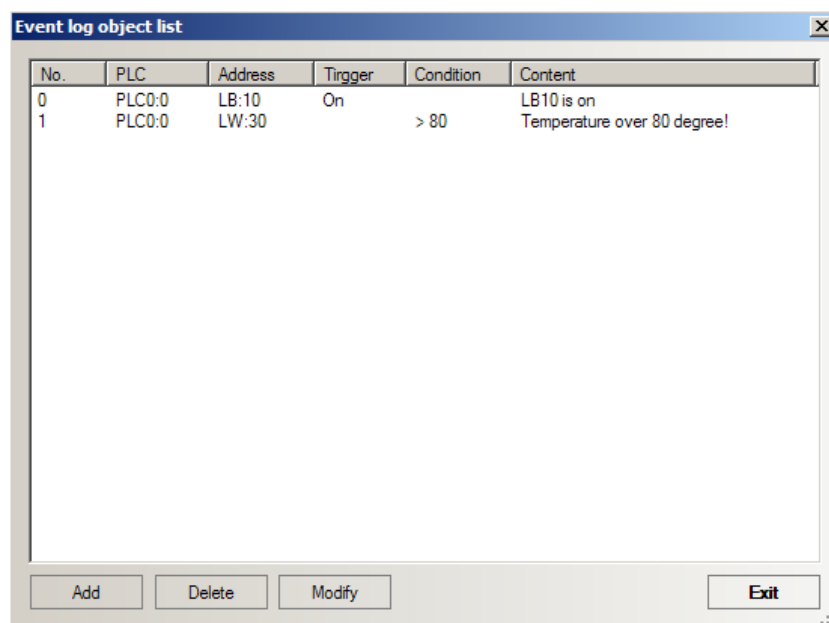

No.	PLC	Address	Tirgger	Condition	Content
0	PLC0:0	LB:10	On		LB10 is on
1	PLC0:0	LW:30		> 80	Temperature over 80 degree!

Note: In order to improve communication efficiency, it is recommended that a block of continuous PLC bit devices be used for the **Event Entry** component. For example: Use Bits100 to 199 to control the display of all event messages. In this case, one read command reads Bits100 to 199 all at once instead of one bit at a time.

6.23 Event Display



Event Display

The **Event Display** component display messages in prioritized order in designated windows. Various formatting features allow the display of event trigger, acknowledge and return to normal times. The use of the Real Time Clock (RTC) or reading time from the PLC is required for proper display of the time.

(This component is only used to display event messages. To enter an event message, the Event Entry component (Event Information logon) is required.)

► Adding event display

1. Click the **Event Display** component icon and drag it to the window, the basic attribution tab of the component attribution dialogbox appears.

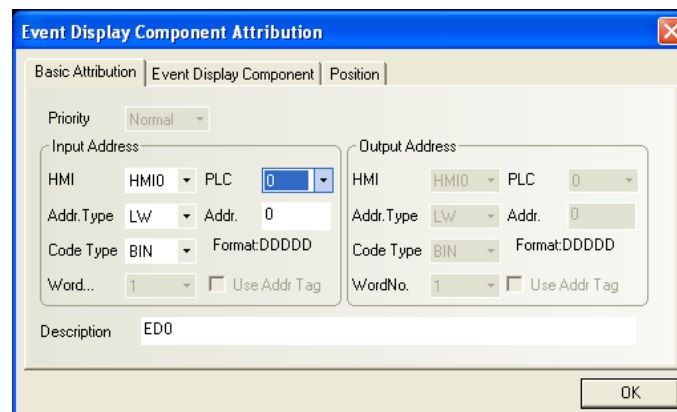

Input Address: The **Input Address** controls the scrolling (up and down) of the event display window. All active event messages are sorted by time, the new events are displayed on top and the older ones are put on the bottom. If the register value is N, the number N message of the order of arrival is placed on the first line of the display window.

Address: The word register address corresponding to the event display component.

Code Type: BIN or BCD.

No. of Words: The default value is 1 for input address.

Use Address Tag: Whether to use the address entered in the address tag library. For details, refer to Section 6.34.

Description: A reference name (not displayed) that you assign to the event display component.

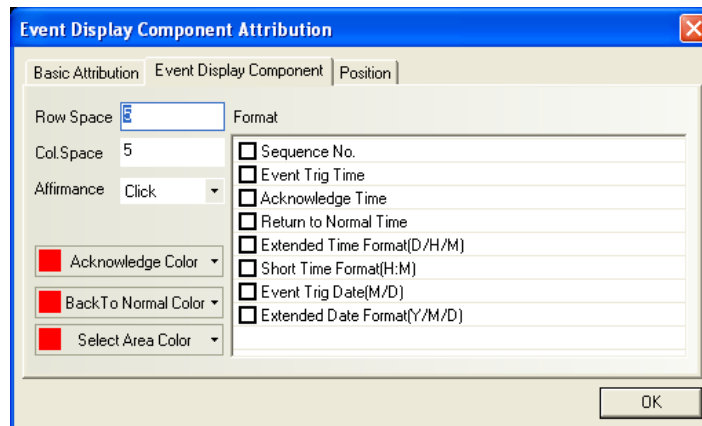
2. Go to the **Event Display Component** tab:

Row Spacing/Column Spacing: The spacing between different rows or columns.

Acknowledge Mode: Click or Double click.

Color:

Acknowledge: The color after the event message is acknowledged.

Return to normal: The color off the event message after it returns to the normal state.

Select Box: The color of the dashed line that indicates which message the user has selected.

Format: Display format of event messages. All added contents (for example, sequence No., trigger time, and so on) will be displayed before the message.

Format Item	Description
Sequence No.	The number of the event. Event numbering starts at 0.
Event Trigger time	The time that the message was triggered.
Acknowledge time	The time that the message was acknowledged.
Return to normal time	The time at which the conditions causing the event returned to a non-triggering state.
Extended time format	Display the time in the format of (DD:HH:MM)
Simplified time format	Display the time in the format of (HH:MM)
Trigger date	Display the date in the format of (MM/DD)
Extended date format	Display the date in the format of (YY/MM/DD)

Sequence No.	Day	Trigger time	Acknowledge time	Return to normal time	Event content
3	2001/05/29	29:10:03	29:10:03	29:10:03	LB10 ON, 请检查
2	2001/05/29	29:10:03	29:10:08	29:10:08	水温高于0度!
1	2001/05/29	29:10:03	29:10:03	29:10:03	LB10 ON, 请检查
0	2001/05/29	29:10:03	29:10:03	29:10:03	LB10 ON, 请检查



Note: Be sure to allow sufficient character length to accommodate all messages. If the Format message and message text exceed the **Character** length, the message is truncated.

As for the method for obtaining day and time, refer to Section 11.3, “**Nonvolatile Local Word**” (LW10000 ~ 10006).

RTC			
Address	Description	Note	Data Type
10000	RTC second	Value range 0 - 59 (R/W)	BIN code
10001	RTC minute	Value range 0-59 (R/W)	
10002	RTC hour	Value range 0-23 (R/W)	
10003	RTC day	Value range 0-31 (R/W)	
10004	RTC month	Value range 0-11 (R/W)	
10005	RTC year	Value range 0-9999 (R/W)	
10006	RTC week	Value range 0-6 (R/W)	
<p>Note on RTC:</p> <p>A user can display system time with a corresponding component, with its value writable. However, the user has to make sure its value must be within the value range; otherwise, the operation will be ignored and the current time value will not be modified.</p>			

- Click **[OK]** and adjust the position and size of the event display component.

◆ Example of Event Display

- Create a new project
- Enter two event entries to the **Event log object list**, as shown below:

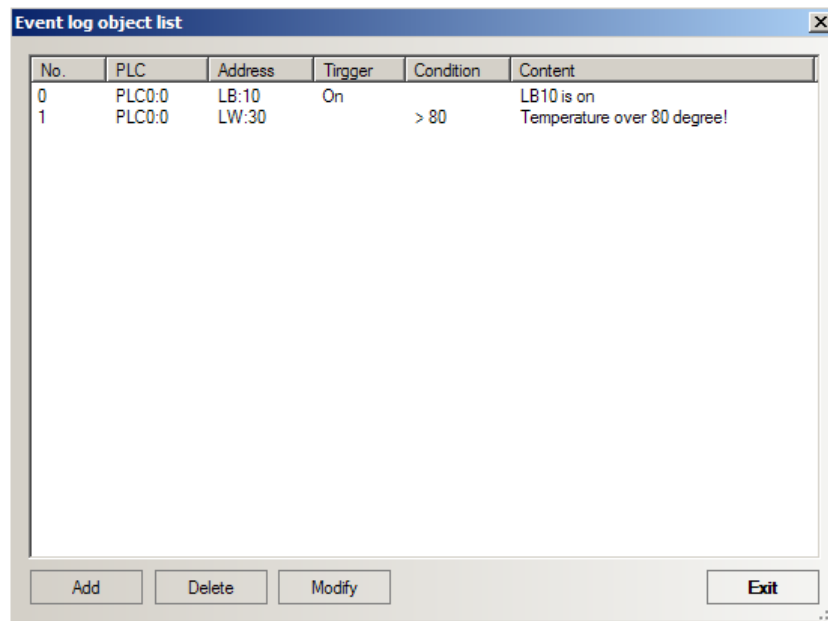

No.	PLC	Address	Trigger	Condition	Content
0	PLC0:0	LB:10	On		LB10 is on
1	PLC0:0	LW:30		> 80	Temperature over 80 degree!

Buttons: Add, Delete, Modify, Exit

Where, the first event corresponds to pop-up window 4 and the second event corresponds to pop-up window 5.

3. Add an event display component to window 0, as shown in the figure below:

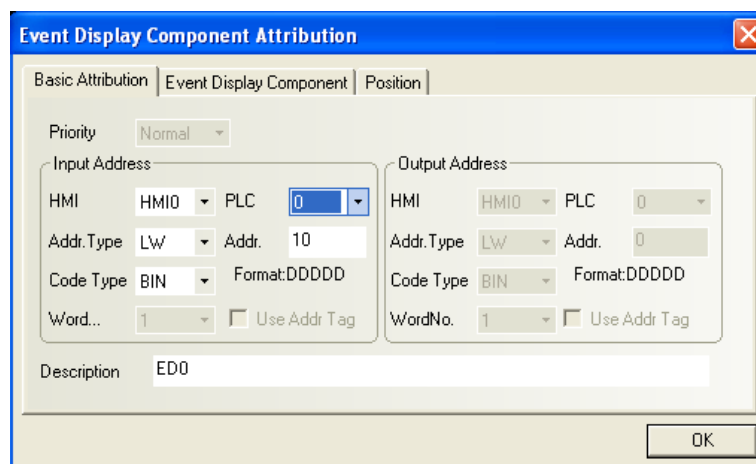

Event Display Component Attribution

Basic Attribution | Event Display Component | Position

Priority: Normal

Input Address: HMI: HMIO, PLC: 0, Addr. Type: LW, Addr.: 10, Code Type: BIN, Format: DDDDD, WordNo.: 1, Use Addr Tag:

Output Address: HMI: HMIO, PLC: 0, Addr. Type: LW, Addr.: 0, Code Type: BIN, Format: DDDDD, WordNo.: 1, Use Addr Tag:

Description: EDO

OK

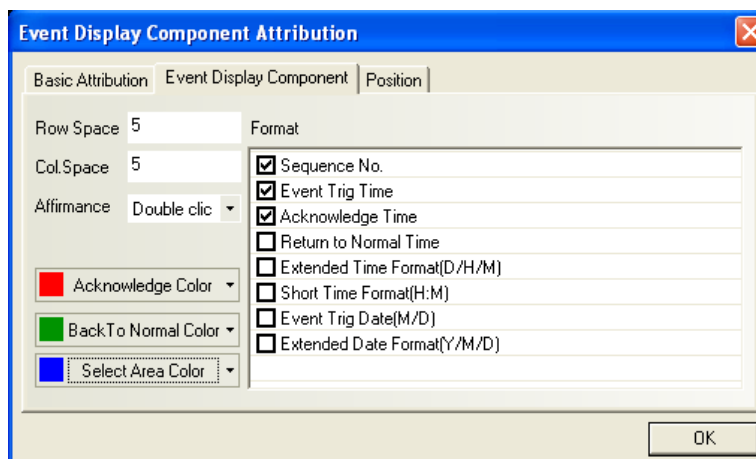

Event Display Component Attribution

Basic Attribution | Event Display Component | Position

Row Space: 5, Col. Space: 5, Affirmance: Double clic

Acknowledge Color: ■, Back To Normal Color: ■, Select Area Color: ■

Format:

- Sequence No.
- Event Trig Time
- Acknowledge Time
- Return to Normal Time
- Extended Time Format(D/H/M)
- Short Time Format(H:M)
- Event Trig Date(M/D)
- Extended Date Format(Y/M/D)

OK

- A vectogram is placed under the event display component to serve as the background image.
4. Add a bit state toggle **switch** to control the ON/OFF state of the LB10 ,a static text with the content “LB10” and a bit lamp for displaying the status of LB10.
 5. Add a static text component to display the content of “Current temperature” and a numeric input component for displaying and change the value of LW30.
 6. Add two Word Setting components for change the value of LW10, which is the input address of the event display component. One of the two word setting component adds 1 to LW10 when pressed and the other subtract 1 from LW10 current value when pressed. The user can use the two buttons for view the event information on the event display area. Note that lower and upper limits should be set for LW10 to avoid unpredicted errors.

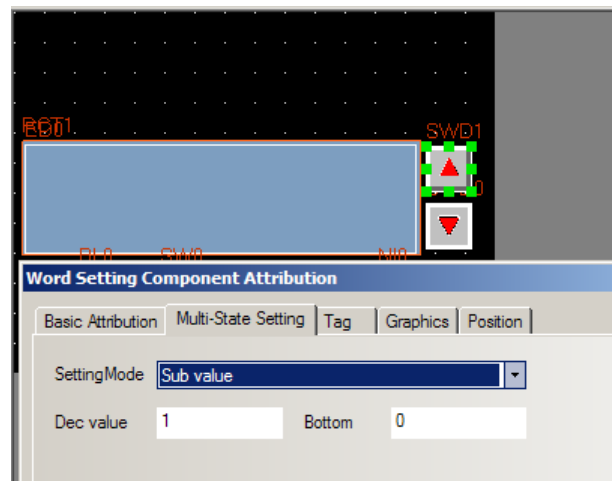
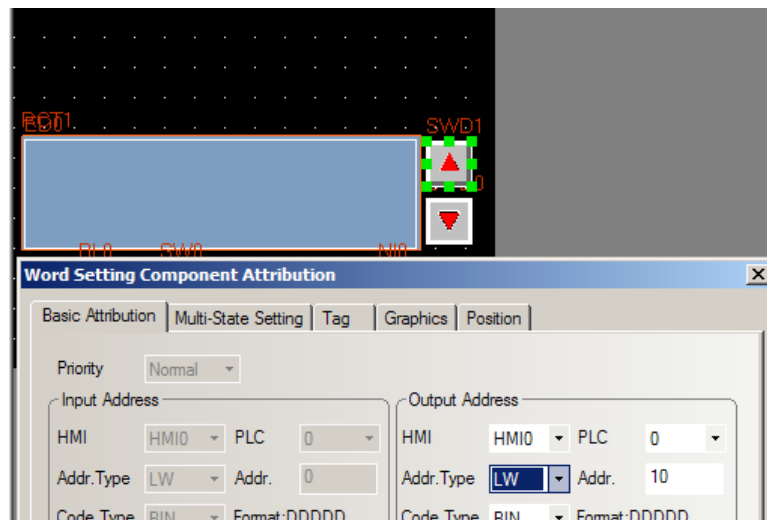

The completed window 0 is shown in the figure below:

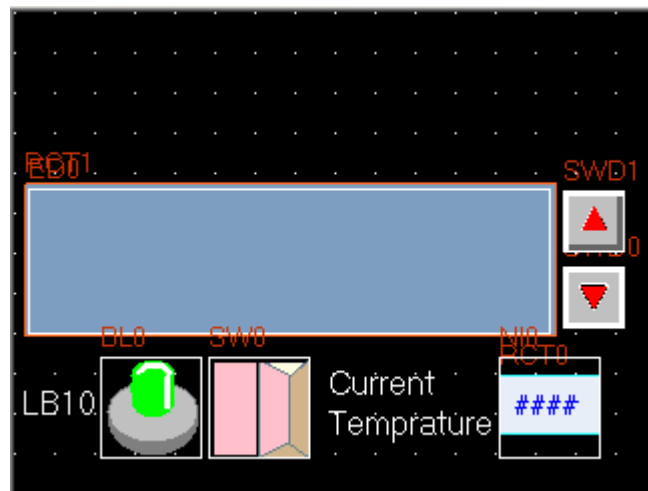

7. Edit window 4, as shown in the figure below, resize the window to 320×85, place a bit toggle switch to change the state of LB10. The position of window 4 is (0,0) so it will appear on the top half of the window when LB10 event information is pressed.

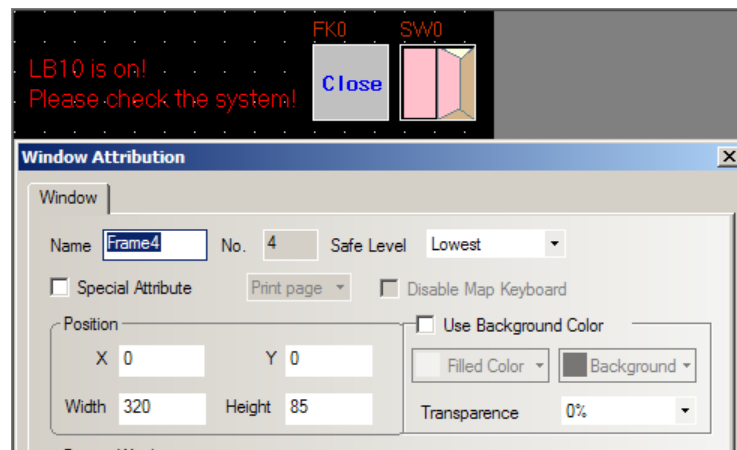

8. Create window 5, as shown in the figure below, resize the window to 320×85, place a numeric input component for setting the LW30 register. The window will appear on the top half of the window when LW30 event information is pressed.



9. Save and compile the project, then perform online/offline simulation or downloading. The operation effect is shown in the figure below:

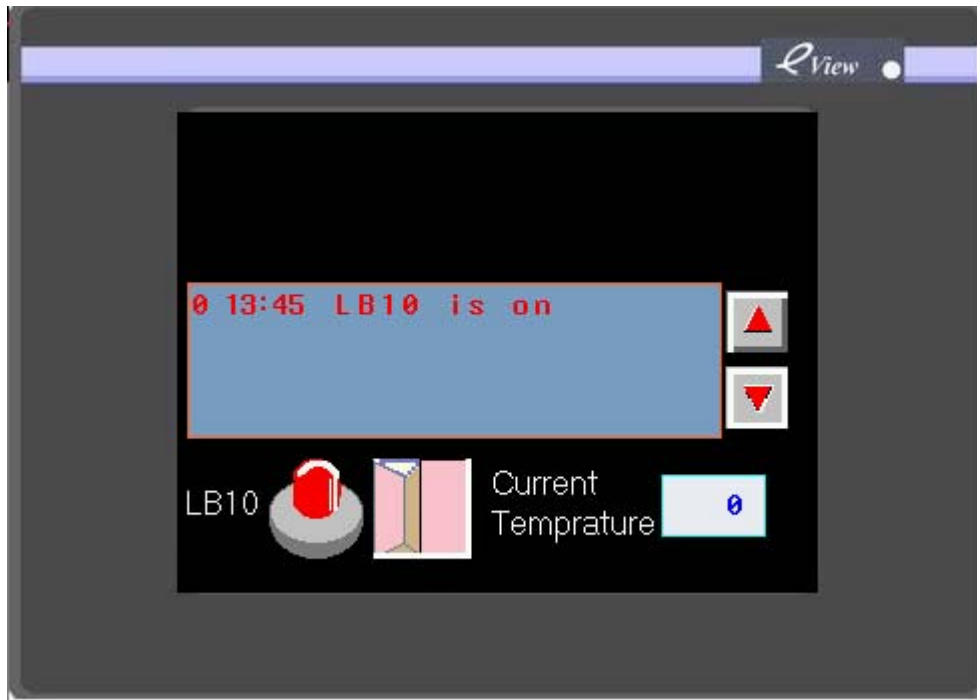

Figure 1, LB10 event is triggered and displayed on the event display area.

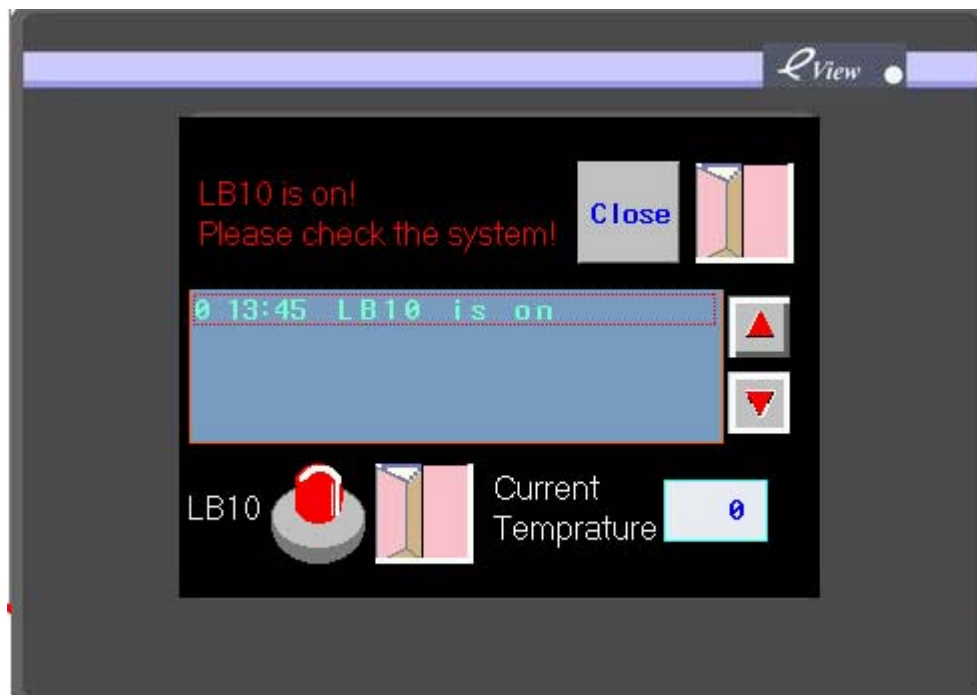

Figure 2. When the user touch the event information on the event display area, window 4 pops up. The user can close the window or toggle the state of LB10. Note that the event information which has been acknowledged is shown in different colors which are designated in the event display component attribution dialogbox.

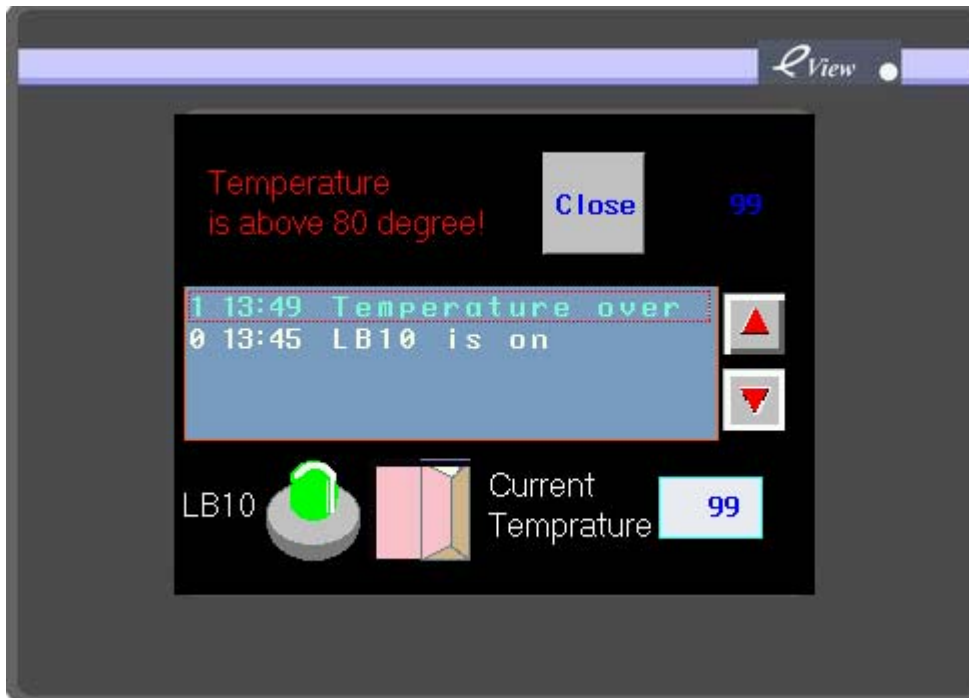

Figure 3. When the “Current Temperature” register is set to 99, above the limit of 80, the LW30 event is triggered and the corresponding event information is displayed on the window. Touch the information will pop up window 5 on the screen. Note that the color of event information 0 has been changed to white, which means the LB10 register has returned to its normal state.

Note:

- a. Do not select the print function if the panel doesn't connect with a printer (On Trigger, Return to Normal). If the print function is selected but no printer is connected, once the event is triggered, the touch screen will display: Print error, which will flicker on the screen.
- b. Pop up windows will only be displayed when the corresponding event information is acknowledged by the operator. To close the pop up windows, place a function key component with the function of closing window on it.(For details about function key components, see section 6.?)

6.24 Alarm Bar



Alarm Bar

The **Alarm Bar** displays triggered alarm messages in the alarm bar area in scrolling way like a banner moving from the right to the left. The messages must be linked to some bit node addresses. The messages are scrolled from right to left in order of triggering. Alarms continue to scroll until they switch to the inactive state. Alarm messages must be entered in the **Alarm Entry**

(Alarm Information Logon) component in advance. (This component is used only to display alarm message. To enter alarm messages, the **Alarm Entry** component is required.)

► **Adding an alarm bar**

1. Click the Alarm Bar component icon and drag it to the window, the **[basic attribution]** tab of the component appears.

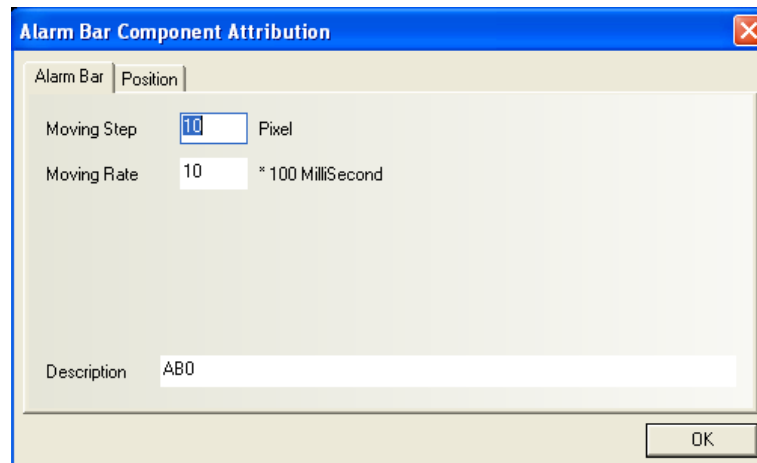

For the moving step and moving speed, the higher the value is, the quicker the scrolling speed will be.

Moving Step: Distance of a step in each moving operation, in the unit of pixels. Bigger step distance means faster movement.

Moving Speed: Time interval between two moving operations, in the unit of 100 ms.

Description: A reference name (not displayed) that you assign to the alarm display component.

◆ **Example of placing an alarm bar**

1. Create a new project.
2. Click the Alarm Information Logon component icon to enter the Alarm List. Add two alarm messages, as shown below:

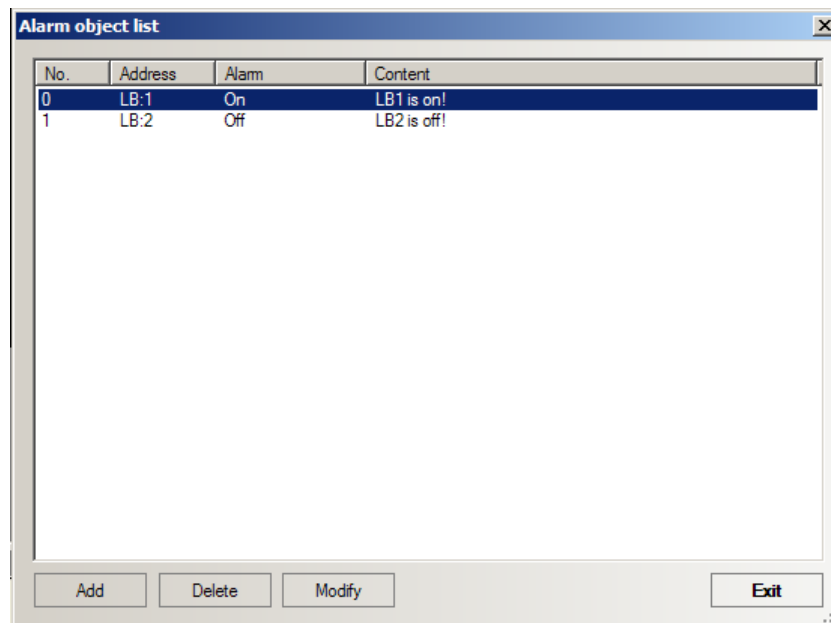

3. Add an alarm bar in window 0. Set the Moving Step and Moving Rate parameters like the following figure:

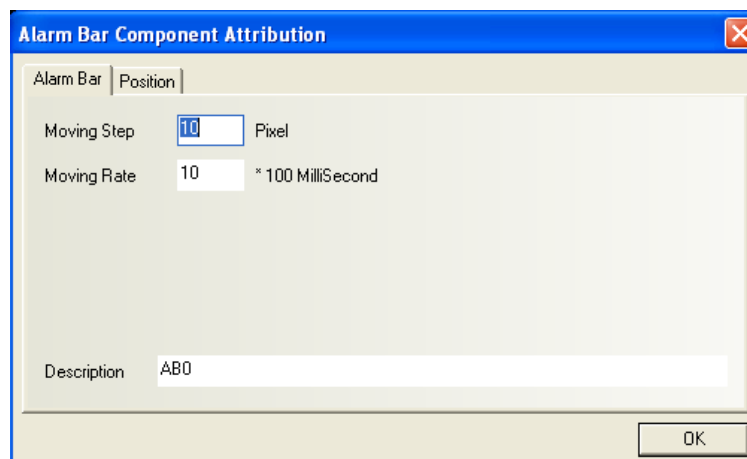

4. Add two bit state toggle switches and two bit lamp to control and display the ON/OFF state of the LB1 and LB2. The ON/OFF state directly triggers the display of alarm messages on the alarm bar.

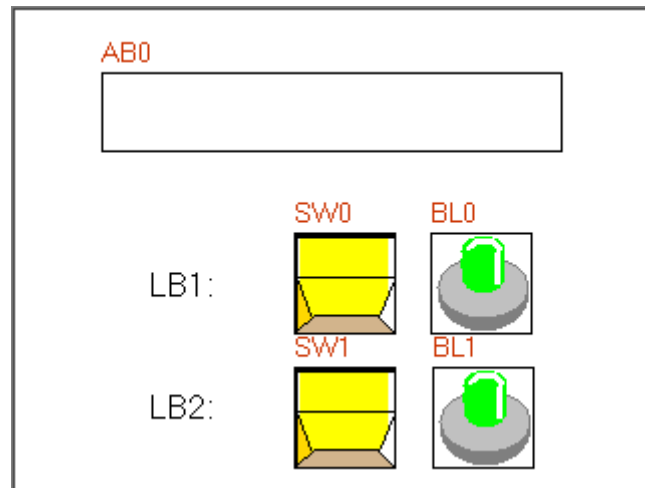

5. Save and compile the project, and then perform online/offline simulation or downloading. The operation effect is shown in the figure below:

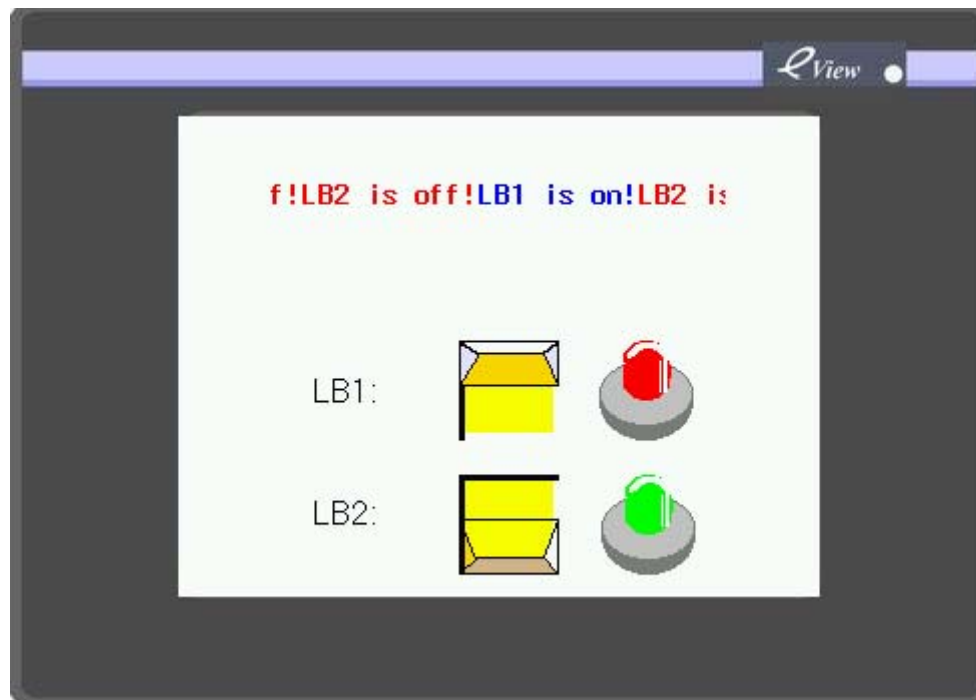

Since the LB1 is set to ON and LB2 is set to OFF, both alarm conditions are met. The two alarm information is displayed on the defined alarm bar area. The colors are different for two alarms, that make them more easy to be distinguished from each other.

6.25 Oscilloscope



The **Oscilloscope** component has similar functions with the **Trend Graph** component. The difference is that when the current window containing the trend graph closes, the background data acquisition continues; therefore, when a user switches back to the trend graph at any time,

the user can obtain the sampling information before the switchover. However, the data acquisition of the oscilloscope is only valid on the current page; in other words, after each switchover, the system will not sample oscilloscope data and the data will get lost. When a user switches back to the oscilloscope window, it will resume data sampling from the very beginning. The advantage of an oscilloscope is that a user can monitor multiple waveforms, for which the long-term monitoring is not necessary, without adding extra background processing loads. Meanwhile, the oscilloscope provides variable-rate sampling function, which when cooperating with a PLC, enables a user to obtain higher sampling frequency, without being restricted to the frequency of 1 point per second.

► Procedure to add an oscilloscope

1. Click the **Oscilloscope** component icon and drag it to the window, the basic attribution tab of the component attribution dialogbox appears.

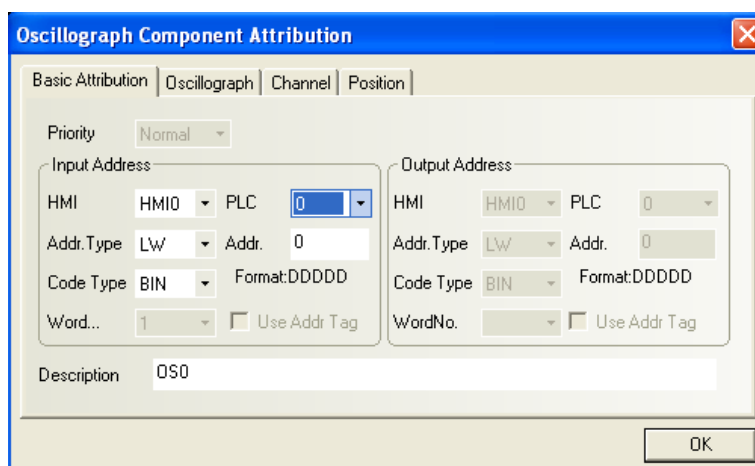

Input Address: Specify the PLC word register address corresponding to the first curve, the second curve data register is located at **Read Address** + 1, and the third is located at read address + 2, etc

Address Type: Select the address type of the register corresponding to the oscilloscope, that is, the monitored register's address type. The address type varies with PLC type. Alternatively, you can also use the internal register of the HMI. For internal registers of HMI, refer to Section 5.4. Please note that some internal registers of the HMI are reserved by the system. Do not use these registers. For details, refer to Chapter 11.

Address: The initial address of the word registers corresponding to the curves in the oscilloscope component.

Code Type: BIN or BCD.

No. of Words: Depends on the number of sampling channels (curves). If the number of channels is N ($1 \leq N \leq 16$) (which means there are N curves to be shown), the **No. of Words** is N.

Use Address Tag: Whether to use the address entered in the address tag library. For details, refer to Section 6.35.

Description: A reference name (not displayed on the runtime screen) that you assign to the

oscilloscope component.

2. Go to the **[Oscillogram]** tab to set related parameters:

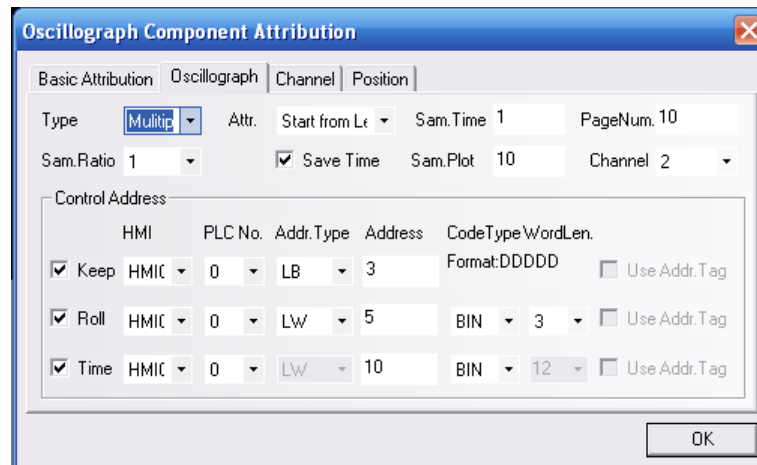

Type: Single page or multiple pages.

If the user selects the single page mode, it will only display the data change of the sampling values in the current page. It does not allow the extension of the oscillogram. If the user selects multiple-page display, it allows the extension of the oscillogram. The data is displayed in the same way, but when the oscillogram rolls forward, the previous sampling data will not be discarded. Previous data will be saved to the memory for future reference. Please note that a maximum of 31 pages of historical data are available, which is determined by the **No. of Pages** parameter.

Attribute: Start from left or start from right. In other words, it determines whether the oscillogram is displayed from the left to right or from the right to left when displaying sampling data.

Sampling Time: Time interval between two sampling points, in seconds.

Sampling Ratio: When selecting values other than 1 for this parameter, the oscilloscope will read the multiple groups of data at a time and display them. For example, if the input address is LW10, number of channels set to 3, and sampling ratio set to 2, the oscilloscope component actually read data from 6 registers (LW10-LW15) at a reading operation. The six registers form 2 groups: group 1 is composed of LW10, LW11 and LW12 while group 2 covers the other three. When the sampling time is 1 second, it will read these two groups of data in each second. It is required that the PLC should prepare these two groups of data in advance at a sampling speed of 0.5S and store them in the corresponding addresses. The oscilloscope can read display two 0.5S data at the same time in one second, so as to display the curve effect of the 0.5S sampling cycle.

Save Time: If this check box is selected, the **Time** box in the **Control Address** frame is available.

Sampling Plot: Number of sampling points for one curve displayed on the graph.

No. of Pages: When the **Type** is set to “**Multiple Pages**”, this box is available.

Channel: Number of tracks to be displayed, corresponding to the number of word addresses of the PLC data. One word register corresponds to one track.

Hold (Keep): The bit address that controls the start or stop of the oscillogram; in other words, the data sampling stops when the [**Hold**] bit is turned ON, and the sampling continues and oscillogram will be dynamically displayed when the [**Hold**] bit is turned OFF.

Roll: Changing the value of this register can implement scroll display of the graph. Each incremental unit can move the oscillogram leftward/rightward by one sampling point. For example, create two numeric setting components, with their register addresses the same as the address of the register controlling the scrolling. Set one component to addition and the other to deduction. In this way, it can turn the oscillogram to the previous or next page.

Time: When the **Save Time** check box is selected, the **Time** box in the lower part of the window will be activated. It includes 12 word registers used to save the time of the latest sampling point. The registers are restricted to HMI local words, the user can specify address for them.

- Go to the [**Channel**] tab and set related parameters of each track.

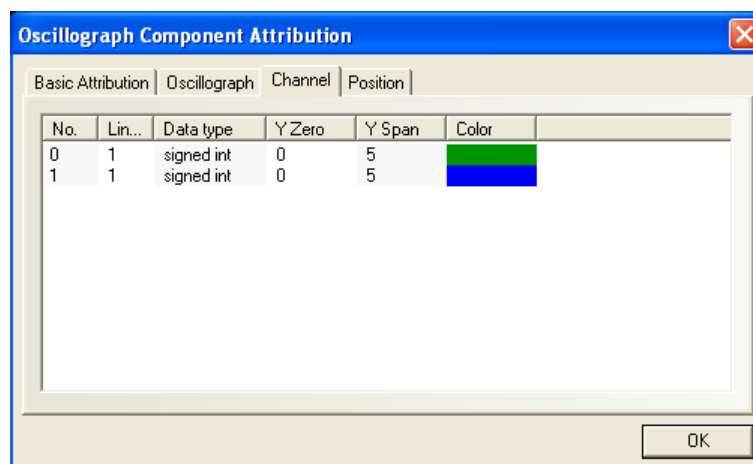

Color: Designate the color of each track.

Line Width: The width of a line, including 8 options.

Data Type: Sets the data type, with only two options of signed integer and unsigned integer.



Max. and Min Value in Y Direction: Set the corresponding maximum and minimum values of each track line along the Y direction.

- Click **[OK]** to complete the setting of the oscilloscope component.

6.26 Scale



The **Scale** is used with trend graph, oscilloscope or XY plot components. It can also be applied on other occasions. Often, it is used with meter component.

► Adding a Scale

- Click the Scale component icon and drag it to the window, and the **[Scale Component Attribution]** dialogbox appears.

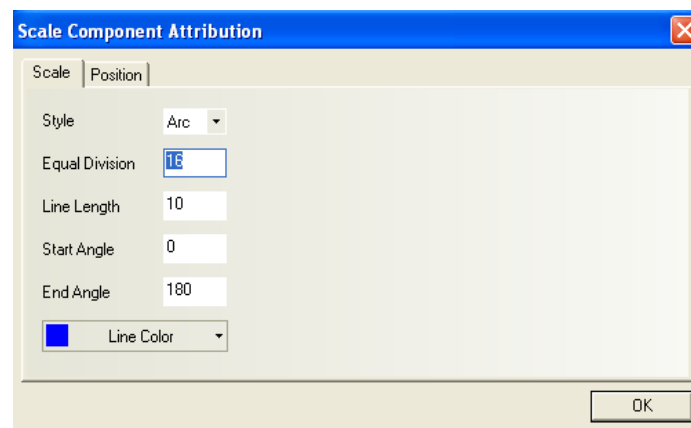

Style: Set the style of the scale: vertical, horizontal, arc, or round. As the following figure shows:

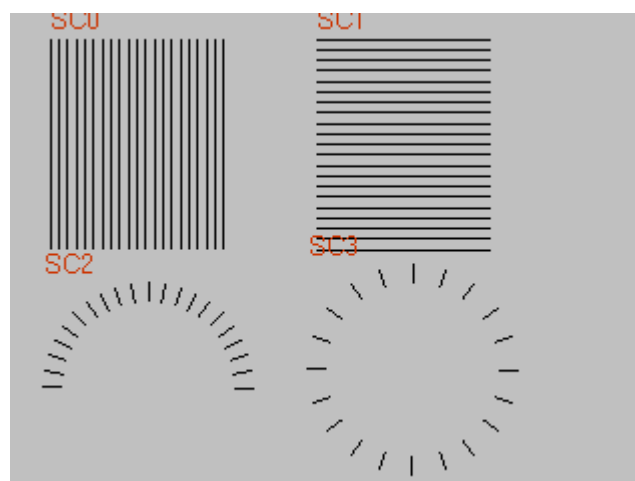

Divisions: Select the number of divisions on the scale.

Mark Length: Select the length of scale mark.

Starting Angle/Ending Angle: Starting angle and ending angle of the arc.

- Go to the **[Position]** tab and adjust the size and position of the scale component. Position and size of it can also be set by using the mouse to drag the component.
- Click **[OK]** to complete the setting.

6.27 Scroll Bar



The **Scroll Bar** is used to control the scrolling of a selected graph, usually trend graph or oscillograph in multiple page mode. It includes word or double word register to define the scrolling scope of the scroll bar.

► Adding a scroll bar

- Click the **Scroll Bar** icon and drag it to the window, the **[basic attribution]** tab of the **[component attributions]** dialogbox appears.



Output Address: The first word or double word register is used to save the current position value; the second word or double word is used to save the position value of the starting point (that is, the starting point in the left or upper most part of the scroll bar, depending on the scroll direction of the scroll bar); the last word or double word is used to save the position value for the end of the scroll bar (that is, the ending point in the right or lower most part of the scroll bar). When you change the value of the first word or double word, the scroll bar will move towards the direction set by you (from left to right, from right to left, from top to bottom, from bottom to top). The step of each motion is 1, and the range of motion is determined by the following two words (double words) registers. Alternatively, you need not set the value of the first register; instead, move scroll bar directly with your hand, the system will calculate the

current browsing index value and write the first word or single word based on the ratio of the position on the whole scroll bar.

Address: The initial address of the word registers corresponding to the scroll bar.

Code Type: BIN or BCD.

No. of Words: No necessary for the user to change the setting, disabled here.

Use Address Label: Whether to use the address entered in the address label. For details, refer to Section 6.35.

Description: A reference name (not displayed) that you assign to the scroll bar.

2. Go to the [**Scroll Bar**] tab:

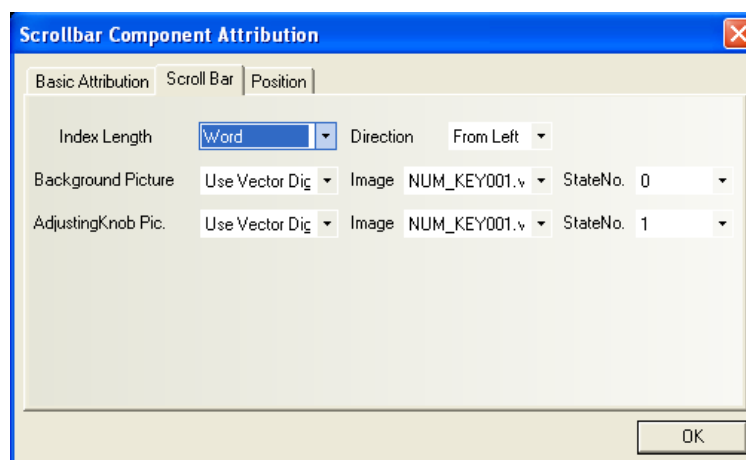

Index Length: Select word or double word.

Direction: Moving direction of the scroll bar, including from left to right, from right to left, from top to bottom, from bottom to top.

Background Picture: The background image to be used by the scroll bar, including such options as **Not Use**, **Use Bitmap**, and **Use Vectogram**. If you select the **Use Bitmap** or **Use Vectogram** option, select a desirable bitmap or vectogram in the **Image** drop-down list box. At the same time, you can select the corresponding **State No.** for the bitmap or vectogram.

Adjusting Knob Image: The adjusting button image to be used for scrolling images, including such options as **Not Use**, **Use Bitmap**, and **Use Vectogram**. If you select the **Use Bitmap** or **Use Vectogram** option, select a desirable bitmap or vectogram in the **Image** drop-down list box. At the same time, you can select the corresponding **State No.** for the bitmap or vectogram.

3. Click [**OK**] and adjust the position and size of the scroll bar component.

◆ Example of Using the Scroll Bar

Add a scroll bar component to the multi-page trend graph described in Section 6.20.2.

Set the output address to LW100, consistent with the scrolling address of the trend graph.

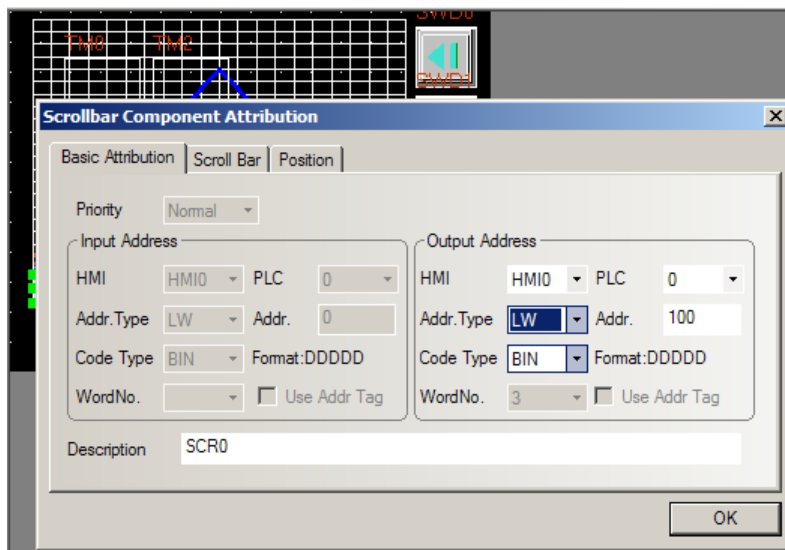

Select the background image and the adjusting button image:

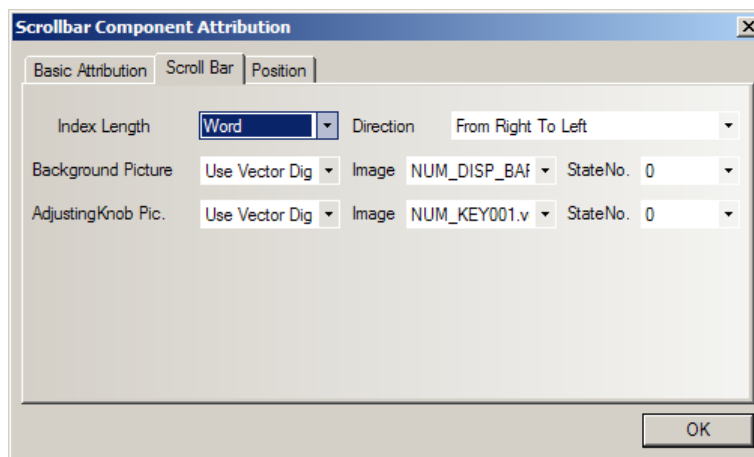

Adjust the length of the scroll bar to the same as that of the trend graph. The configuration after setting is shown as follows:

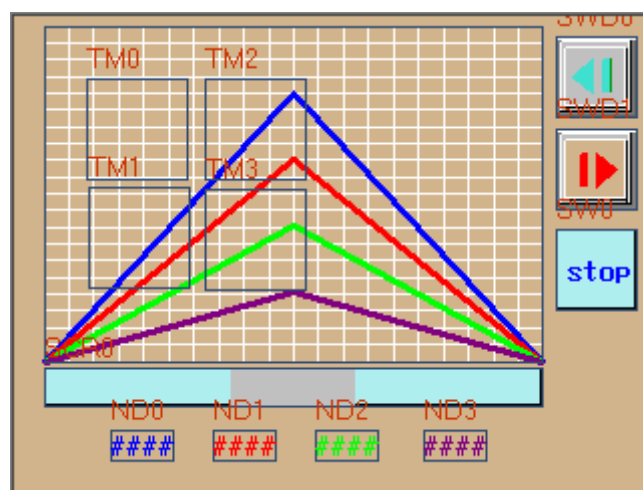

The operation effect is shown as follows:

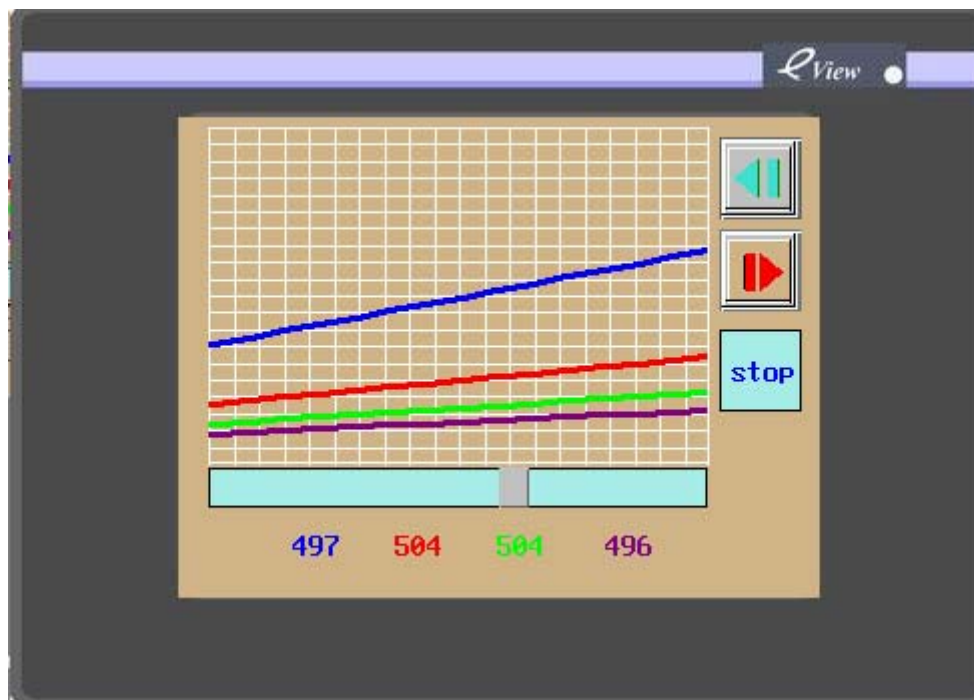

When the display remains still, click a position in the scroll bar to move the current display to the corresponding page in historical data. It implements the browsing function similar to that in a Windows system and it is easy to use.

6.28 Message Board (Note Pad)

The message board is used as a canvas for users to save and transfer messages. The user can write some notes on the HMI at will. It is similar to the **Paint**, but we can only use fingers or a stylus to write on the message board.

► Procedure to add a message board (Note Pad)

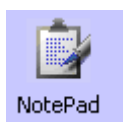

1. Click the **NotePad** icon and drag it to the window, the **[Message Board Properties]** dialog box appears.

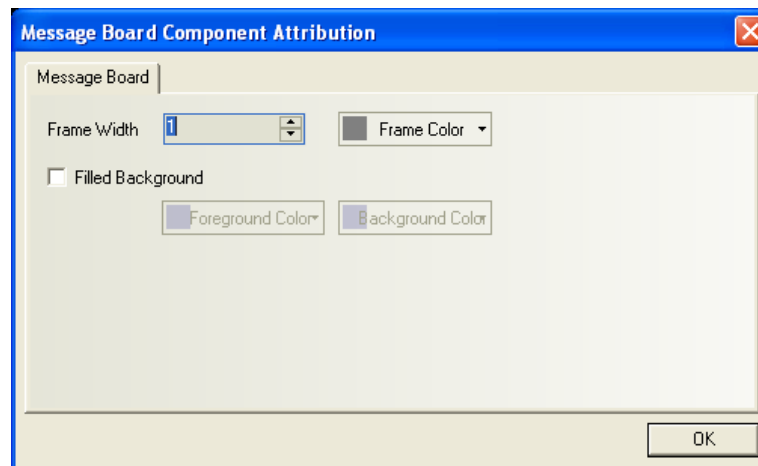

[Frame Width]: The width of the message board frames.

[Fill Background]: Select the frame, background and foreground color, or you can leave it empty.

2. Click the **[OK]** key and adjust the position and size of the message board component.

Tools of the message board like Brush Color, Brush Width and Clear Screen are provided by function key component. After placing the **message board**, place a function key component on the window, the [Function Key] tab of the [Function key Component Attribution] dialog box appears. There is a function block titled “Message Board”. Select this function block and designate the specific function for the function key component.

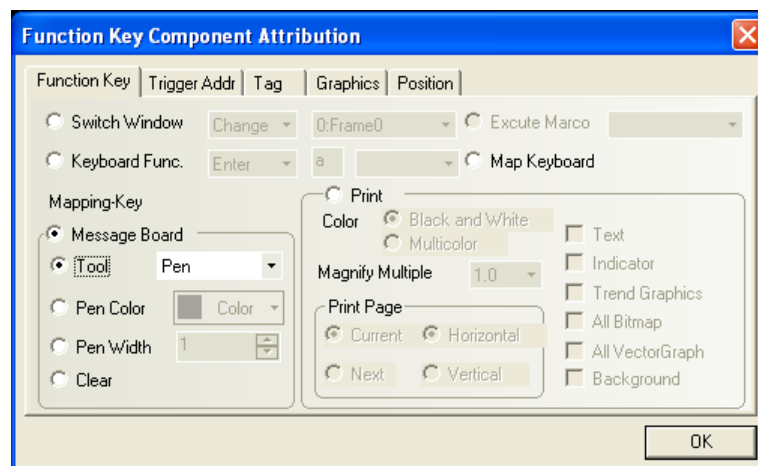

(1) The **[Tool]** drop-down list box provides the following options:

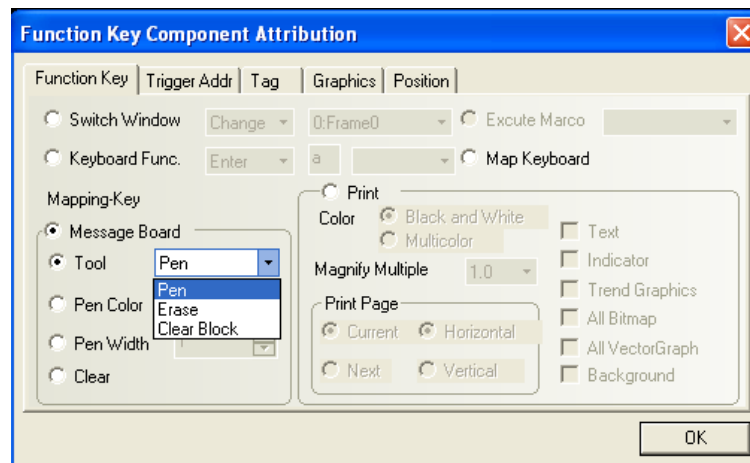

[**Brush**]: Select a brush and then you can write down messages or draw a picture on the message board.

[**Eraser**]: Erase the contents on the message board.

[**Block Cleanout**]: Clean out the contents in a selected area in the message board.

(2) [**Pen Color**]: Set the color of the brush, as shown below:

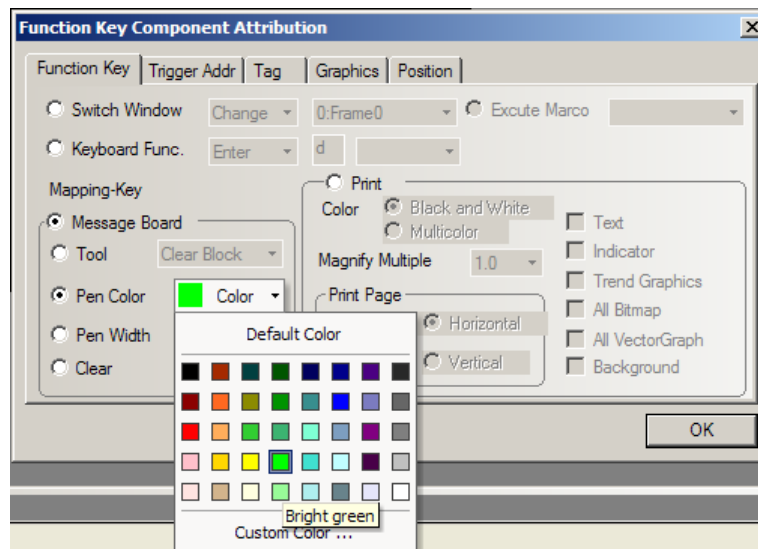

(3) [**Pen Width**]: Select the width of the pen, with the value range of 1 ~ 8; the number 1 indicates the thinnest brush and the number 8 indicates the thickest brush, as shown below:

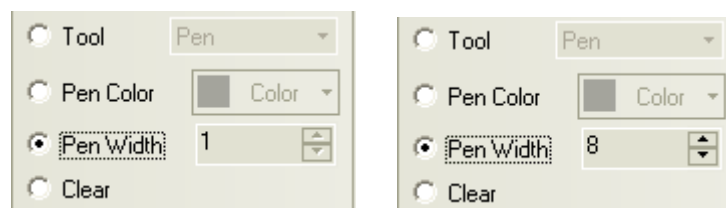

(4) [**Clear Screen**]: Clear all contents in the message board.

◆ Example of using Message Board

1. Create a new project.
2. We take window 0 as the message board window, for example. You can also select other window as the message board window. Just drag the message board component to window 0.
3. Set the properties of the **[message board component attribution]** dialog box, as shown in the figure below:

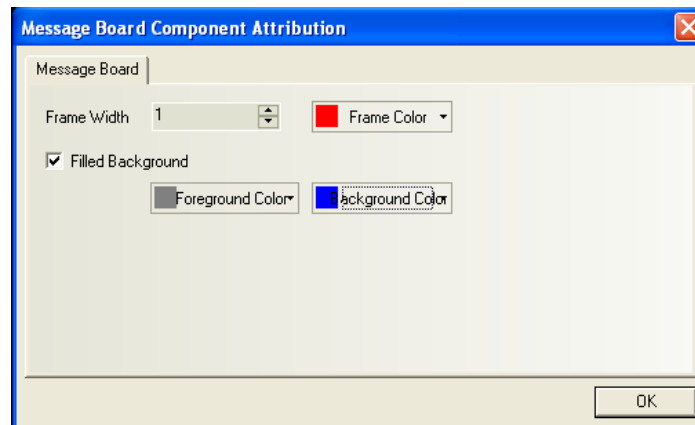

[Frame Width]: With the value range of 1 ~ 16; select 4 in this example.

[Frame Color], [Foreground Color], [Background Color]: Select your desirable color.

4. Adjust the message board to an appropriate size, as shown below:

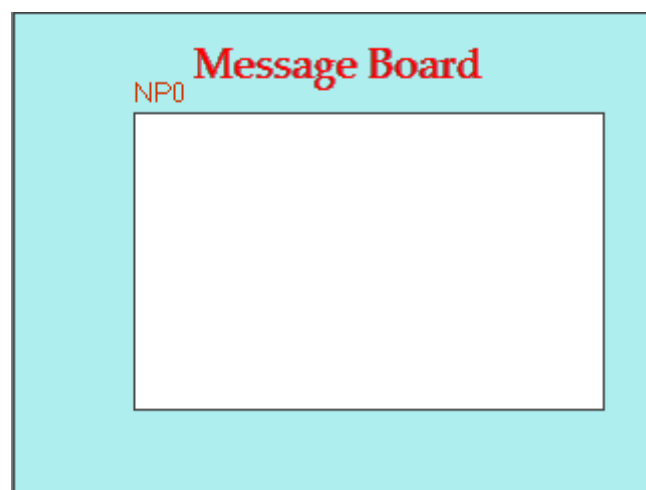

5. Add some function keys to the left and lower part of the message board. Select function keys FK0, FK1, FK2, and FK3 respectively for **[Pen]**, **[Eraser]**, **[块清除] (Block Cleanout)**, and **[Clear Screen]** functions. Select FK4, FK5, and FK6 respectively for the pen color of red,

green, and blue. Select FK7, FK8, FK9, and FK10 respectively for the brush width of 2, 4, 6, and 8, as shown below:

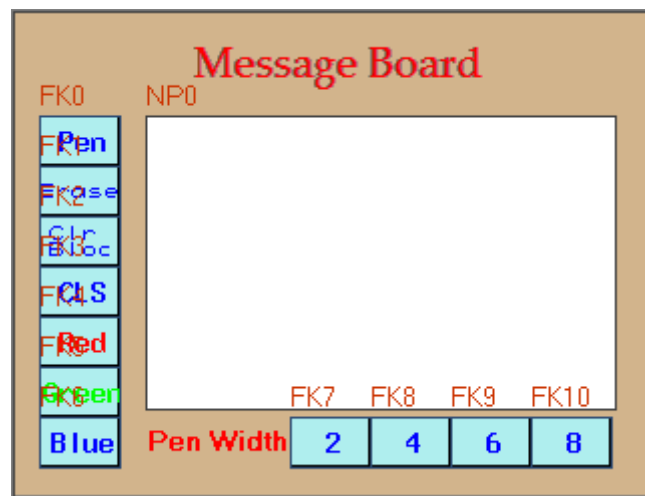

After setting these options, save and compile the project, perform online/offline simulation or downloading. The operation effect is shown in the figure below:



LB9020 - LB9022 are reserved by the system to control and identify whether the brush, eraser, and block cleanout functions are selected. LB9030 - LB9032 are used to set the pen width. LB9006 is used to set message board operation mode. LW9007 is used to set the brush thickness.

LW9008 can select any one color for the brush among all 256 colors. For details, refer to related parts in Chapter 11, “**Reserved Register Addresses of the System**”.

Note:

1. Each HMI panel can use only one message board component. If there are several message boards, the contents must be consistent, as they share the same storage area.
2. Data in the message board will not be saved and will get lost after power failure of the HMI. Do not write recordable messages on the message board.

6.29 Function Key



The **Function Key** can be used to change screen display, input digit or ASCII character, maximize or minimize window and move window, design message board, or print.

► **Procedure to add a Function Key**

1. Click the Function Key icon and drag it to the configuration edit window, and the **Function Key Component Attribution** dialogbox appears. Click the **Function Key** tab to set the various function and behavior of function key component.

These functions are: Switch Window, Keyboard Function, Message Board and Print.

The details about these functions are discussed below.

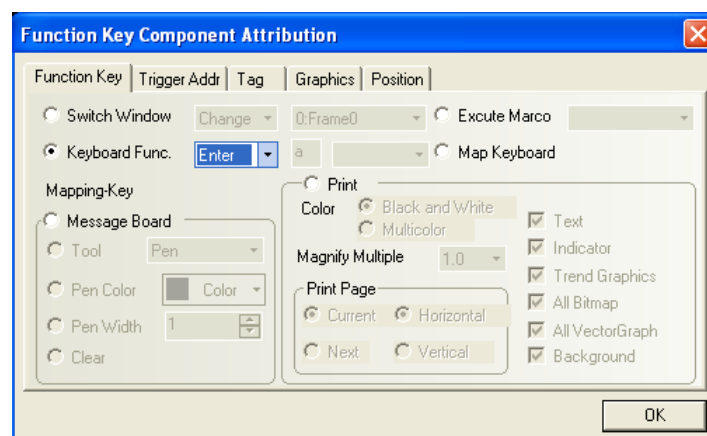

2. **[Trigger Address]** tab is reserved for special use, don't change the default setting here before contacting Stepservo Technician.
3. Go to the **[Tag]** tab: Select use tags and input the proper tag for the function key.
4. Go to the **[Graphics]** tab: Select vectogram or bitmap to display states.
5. Click OK and adjust the position and size of the **Function Key**.

6.29.1 Switch Window

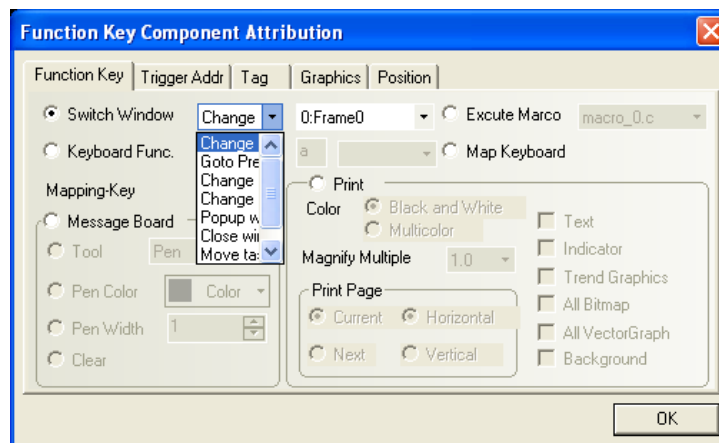

If the function key component is used to manipulate the window, select the **Switch Window** option, there are some specific window operation options in the list on the right. Among them are **Change basic window, goto previous, change common window, change fast selection window, popup window, close window, move task bar** and **minimize window**.

Change Basic Window

If this option is selected, when the function key is pressed, the current basic window (including all of its sub-windows) will be terminated and it will display the basic window designated by the window number selected from the list on the right. The basic window to be switched to must be an existing one so it can be selected in the list.

Goto Previous (Window)

This function closes the current basic window and recalls the last active basic window. It is only valid for basic windows.

For example, if basic window 21 is the basic window displayed just before window 32, and window 32 had a function key defined as **Return to Previous**, then, when the function key is pressed, the screen will be clear and displays window 21.

Change Common Window

If the function key is set as **Change Common Window**, when the touch area is pressed, the current common window will be replaced by the specified window as new common window. Also the new common window is designated by selecting from the list.

Change Fast Selection Window

This function changes the fast selection window. The window specified in this function must be the exact same size as the original fast selection window (window number 2 by default).

Pop-up Window

If the function key is set as “**Pop-up Window**”, when the touch area is pressed, the window designated by window number selected from the list will be displayed over top of the current base

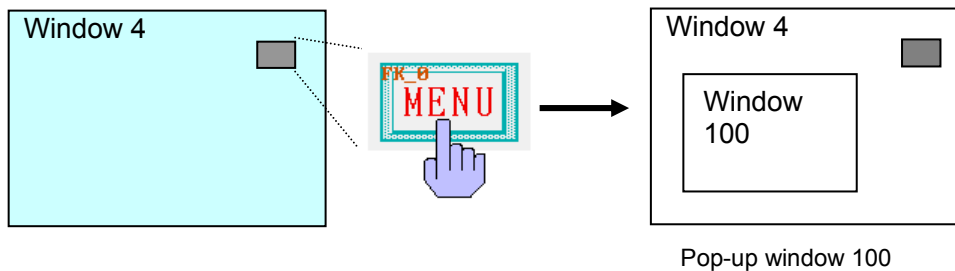

window. The existing window(s) will not be terminated.

Close Window

A Close Window function key terminates the pop-up window where it is placed when pressed. However, it cannot close direct or indirect windows. The open/close of direct (indirect) windows are controlled by their corresponding bit (word) registers, and the **Close Window** function key can only close pop-up windows and cannot control the register data.

Popup Window Title Bar

A function key defined as [**Popup Window Title Bar**] is used to move the position of a popup window on the screen. A pop up window on the screen, that has a function key inside the window with the “popup window title barwindow bar” attributes, can be moved by touching the title bar then touching a another position on the screen, the window is moved to that place.

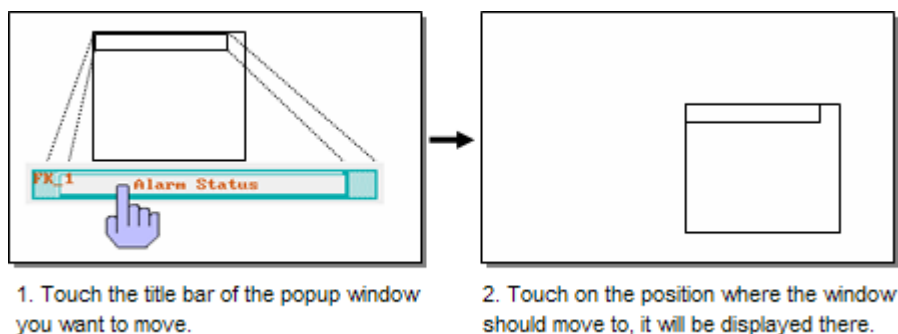



Minimize Window

If a pop up window on the screen has a function key set to perform **Minimize Window** function in it, when the function key is pressed, the window will be minimized to a window icon on the taskbar at the bottom of the screen. A touch on the window icon will maximize the window again.

◆A comprehensive example of function key related to window manipulation:

In this section, we provide a detailed example containing all the function related to window

manipulation. After finishing the application project under the following instructions, the user can simulate this project to observe the behavior of these function keys. Also, the user can get a better understanding of some basic conception about window such as basic window, fast select window, common window and task bar.

1. Create a new project and save it. (Select any type of PLC for this project doesn't use any PLC register.)
2. The default project wizard has five windows: basic window 0, window 1 with two direct window components for the default number input keypad, window 2 as the default fast selection window, window 3 as the default number input keypad and basic window 4. They are in the project after creating and cannot be deleted. After creating the project, the window shown in the edit area is window 0, use  1:Frame1  to change the window shown in the edit area. Double click in the blank area of a window will invoke the **Window Attribution** dialog box of that window. Shift to window 2, the default fast selection window, and double click to show the Window Attribution dialog box. There you can see that the window is 100 pixels wide and 220 pixels high with a frame of the width of 5 pixels. Click  to add a new window into the project, the new window will be designated window 5. Open the window attribution dialog box to set the size of window 5 the same as window 2 and add the same kind of frame. Add two more window: window 6 and window 7. Window 6 will be used as a basic window and window 7 will be a pop-up window. Change the size of window 7 to 200 pixels wide and 150 pixels high.
3. Place three function keys on window 2, that is, two **Change Basic Window** function keys can switch to basic window 0 and basic window 4 respectively, and a **Change Fast Selection Window** function key can switch current fast selection window from window 2 to window 5. Add tags for these function keys for indicating the operator the function they will conduct when pressed, the finished window 2 is shown as below:



4. Click  on the drawing toolbar to place a static text component on window 1. The content of

the text is “**Common Window 1**”.

- Place a static text component on window 0 with the content “**Base Window 0**”. Place a function key whose function is **Goto Previous** and labeled as “Return”, and a **Pop-up Window** function key with the label “Popup window 7” to pop up window 7, as shown in the figure below:

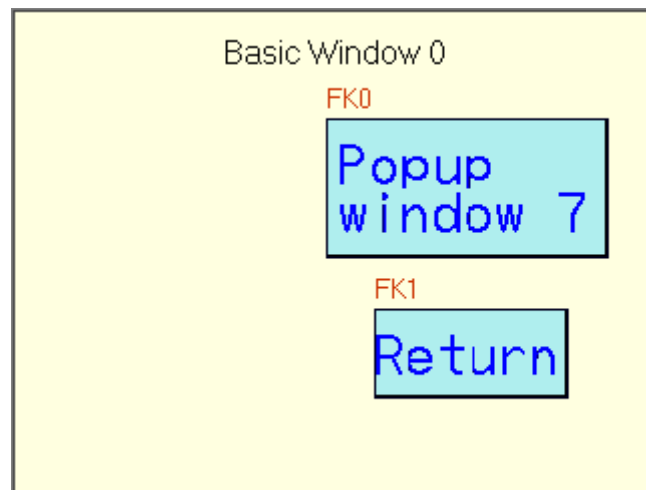

- Place a text component on window 4 to display the text of **Basic Window 4** and a **Return to Previous** function key with the label “Return”.

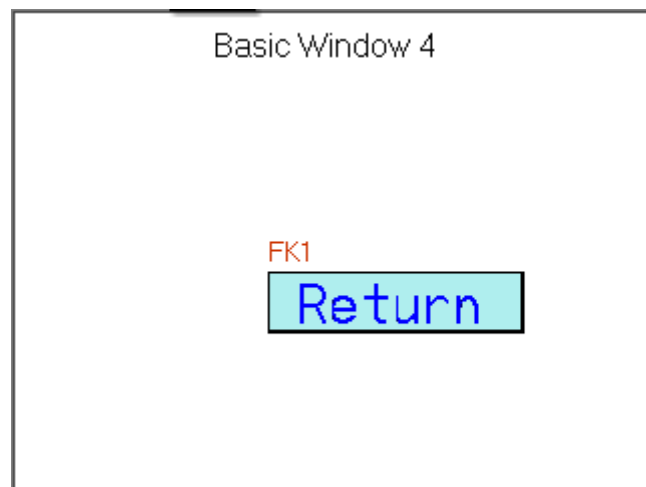

- Place a **Fast Selection Window** function key on window 5 for switching to fast selection window 2, a **Change Common Window** function key for setting window 1 as the current common window, and a **Change Common Window** function key for setting common window 6 as the current common window.



8. Place a static text component with the content “Common Window 6” on window 6.
9. Place a **[popup window bar]** function key on window 7 to display the title of Pop-up Window, a **[Minimize Window]** and a **[Close Window]** function key.
10. After setting these options, save and compile the project, run online/offline simulation or downloading. The operation effect (simulation) is shown in the figure below:

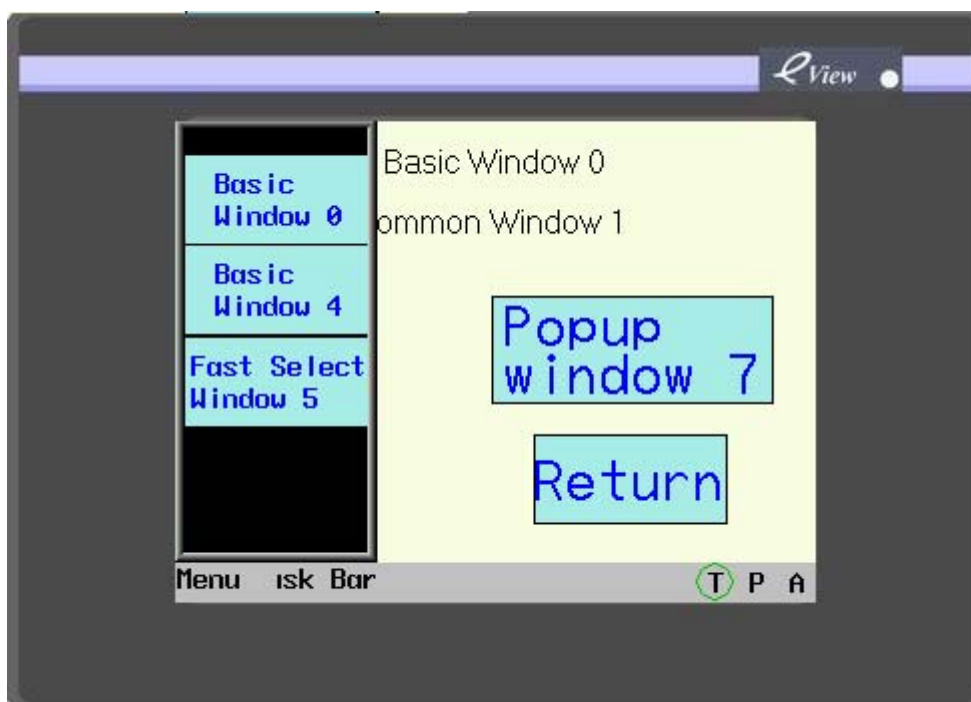

11. Press function keys in a fast selection window to switch from window 0 to window 4, press **Return** to return to window 0. Then, press **Return** in window 0 to return to window 4.

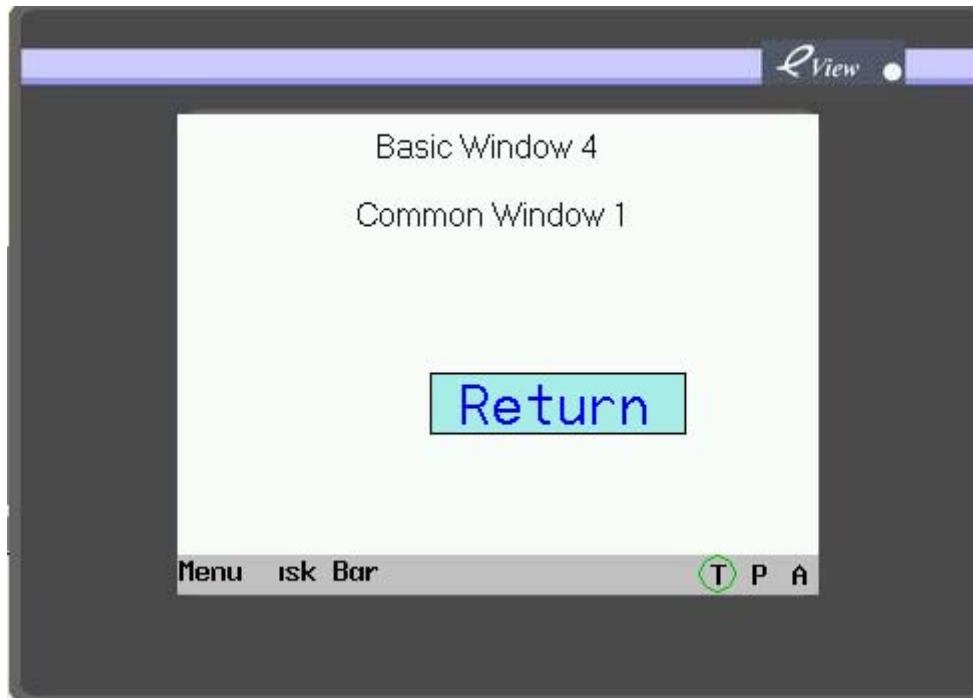

12. Press **Pop-up Window** in window 0 to pop up window 7, as shown in the figure below:
 (The user can move, minimize or close the pop-up window.)

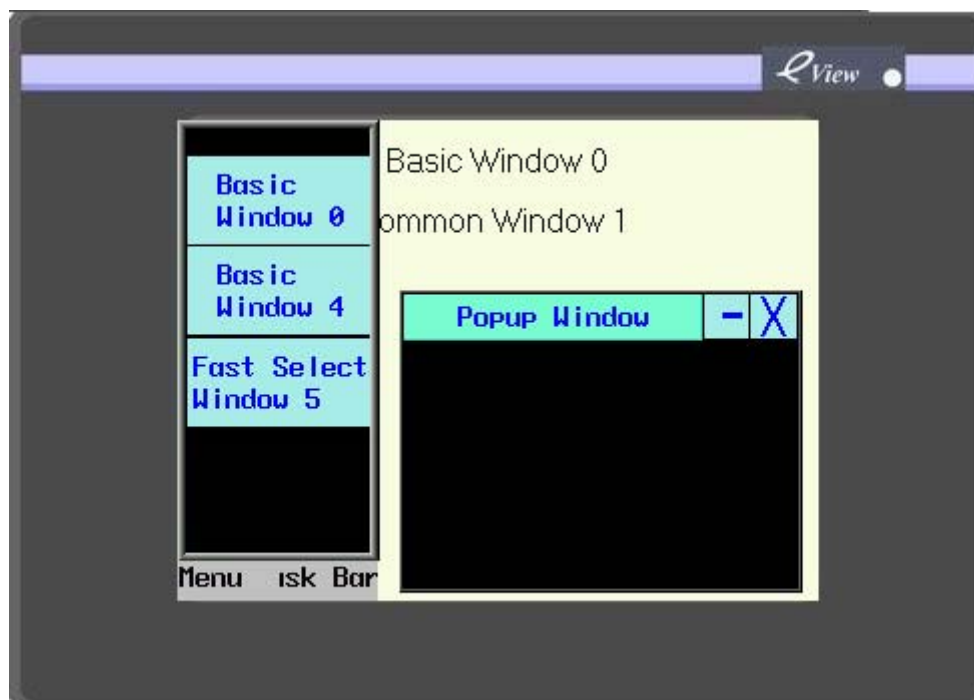

13. Press **Fast Selection Window 5** in the fast selection window to switch to fast selection window 5, as shown in the figure below:

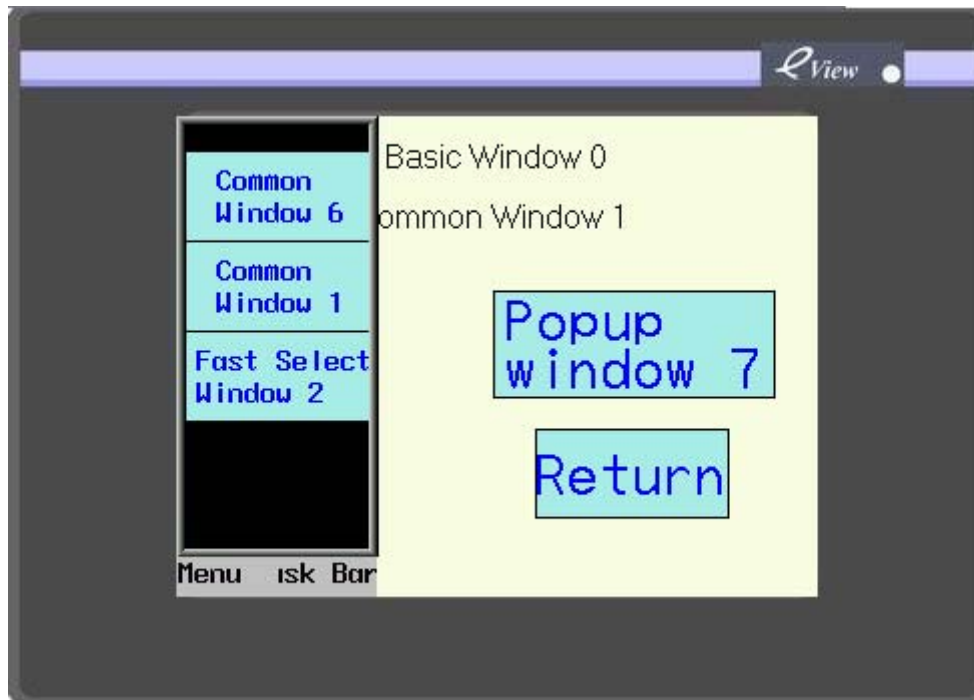

14. Press **Common Window 1** or **Common Window 6** to switch between common windows:

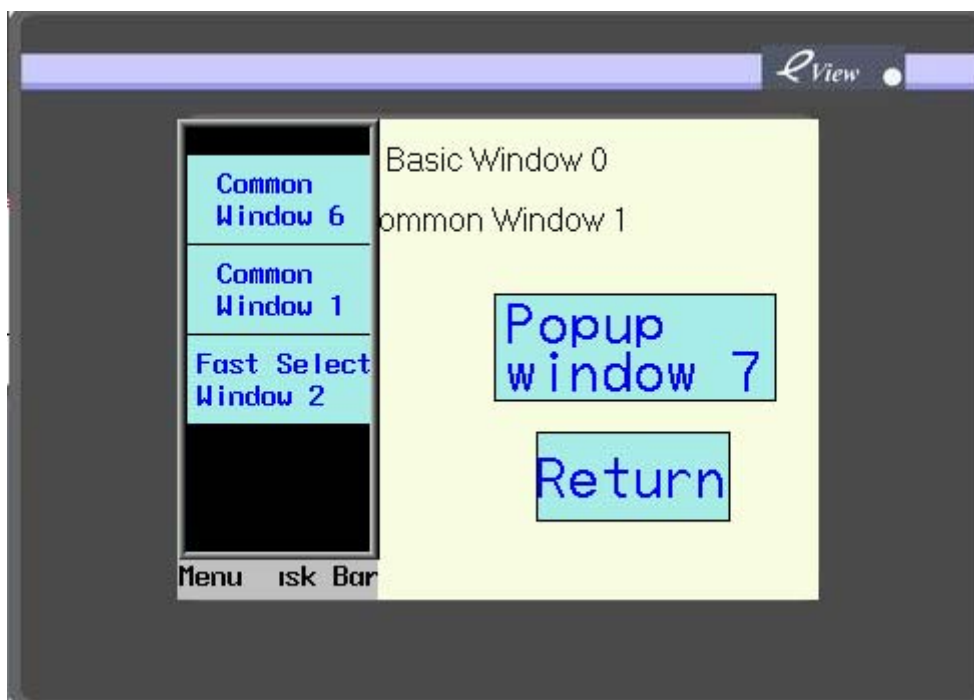

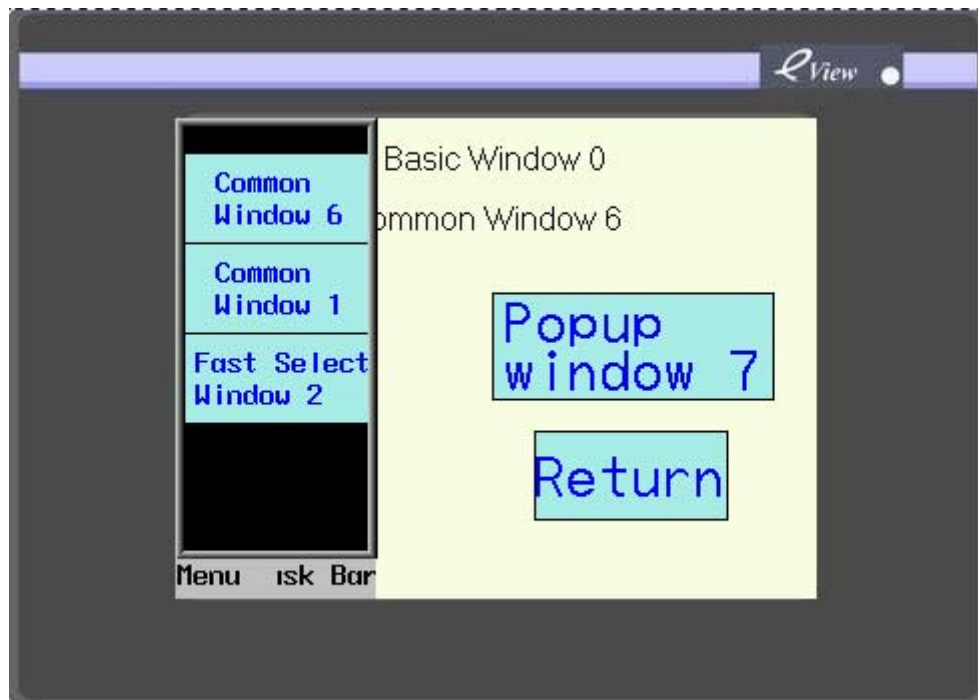

6.29.2 Keyboard Function

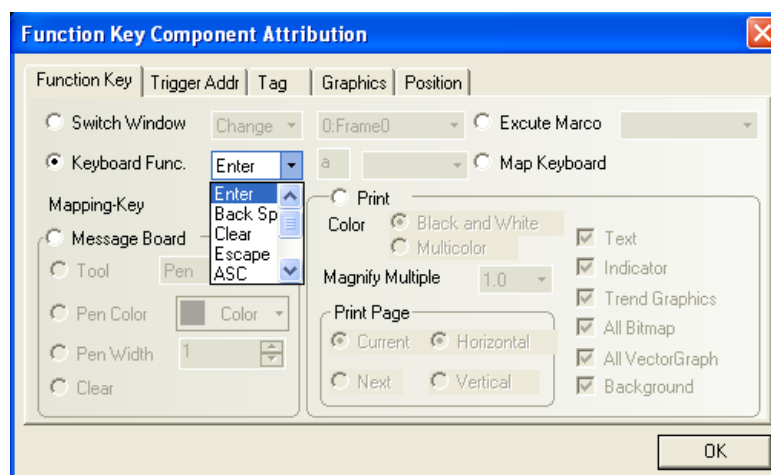

A keypad is composed of a variety of function keys with different ASCII codes (0, 1, 2... and a, b, c...) and special keys such as “Enter”, “BS”, “ESC” and “CLR” etc. Since any character can be assigned to a function key, specialized keypads can be made for any application. Keypads are used with the **Numeric Input** or **Text Input** components to enter numeric values.

◆ Create a keypad for numeric input component

1. Create a new window, place **function key** components used for input the numbers and characters: 0, 1, 2, 3, 4, 5, 6, 7, 8, 9, ENT, BS, CLR, “-”, “.”, as shown below:



Set the FK_0 for input digit “1” as follows:

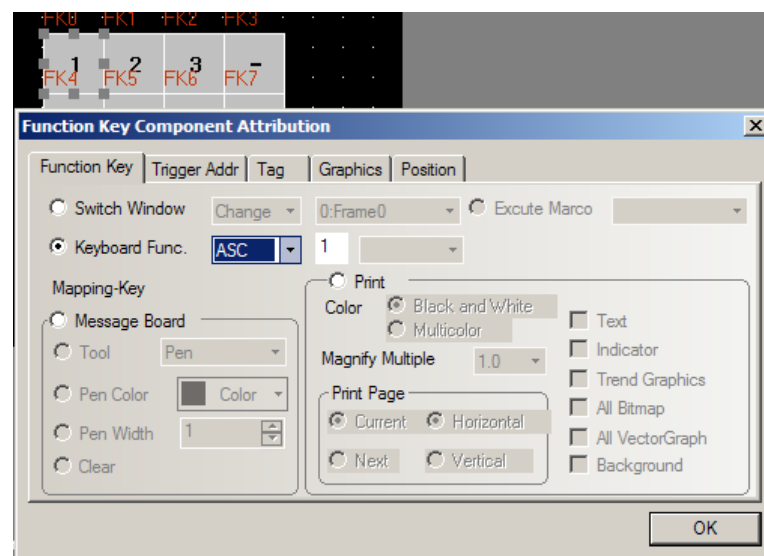

Set other function keys (FK_1~FK_14) as follows: Other characters (2) ~ (9), (0), ENT, CLR, BS, -, ".

- Put a Number Input Component in window 0 and set the necessary parameters (see relative sections for details.).
- Save and compile the project, conduct the off-line simulation. When the **Numeric Input** component is activated, the function keys (FK_0 ~ FK_14) become the keypad for numeric input.

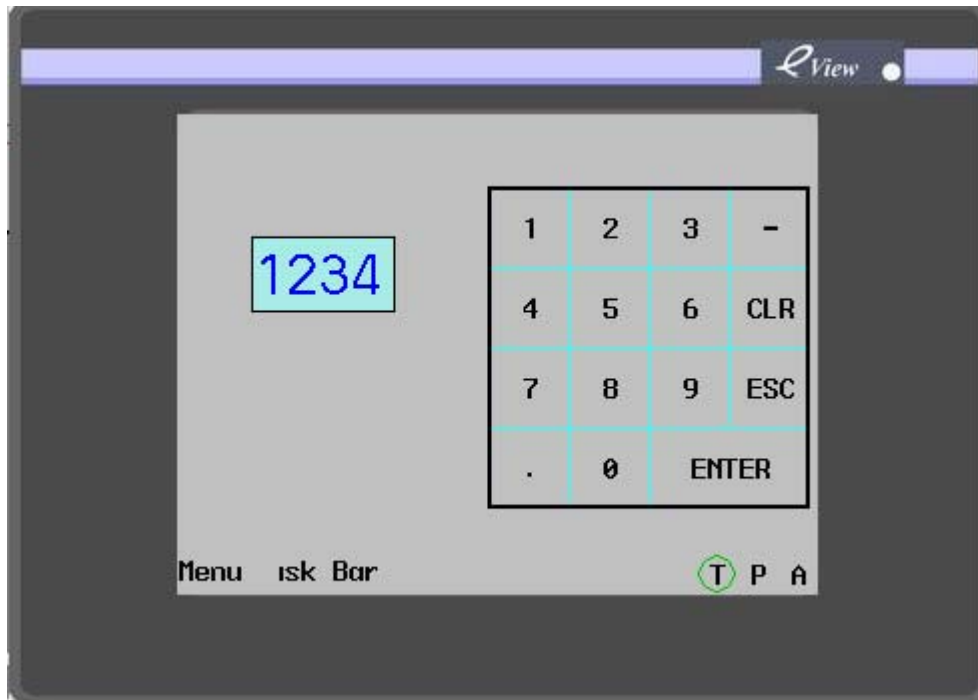

6.29.10 Printer function

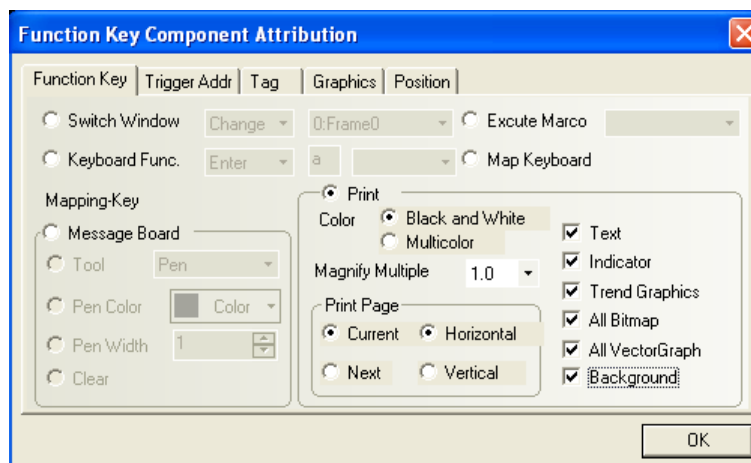

Refer to Chapter 10, "Print".

6.30 Timer



The **Timer** is a timing device and will execute corresponding function when the timing time arrives. It can implement such function as executing macro code, setting parameters, and transferring data. ,

- **Various Functions of Timer**

1. Click the Timer component icon and drag it to the window, and the [Timer Component Attribution] dialog box appears. Click the [Timer] tab:

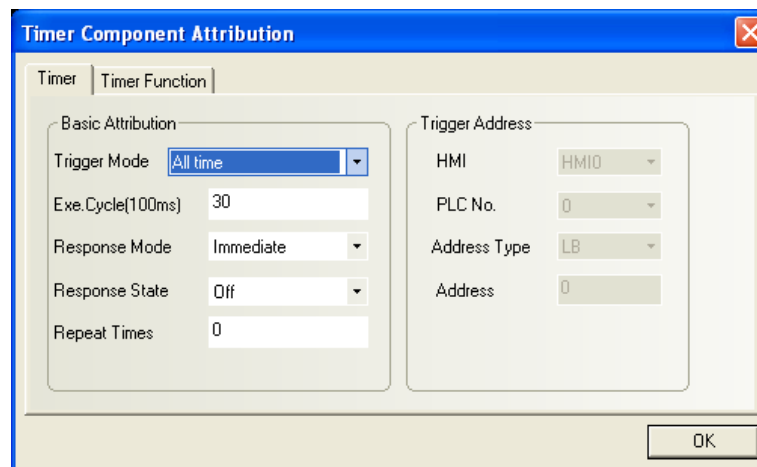

➤ Basic Attribution

[Trigger Mode]: Include such options as **All time**, **Initial Frame (Triggered at Window Initialization)**, **Close frame (Triggered at Window Close)**, and **by register address (Triggered by Register State)**.

Always TriggeredAll time:

If this option is selected, the timer will be triggered upon initialization regardless of the trigger mode to execute the triggered operations until the times designated by the **[Repeat Times]** reach. Then, it will not be triggered until the next initialization.

Initial Frame:

The timer will be triggered upon initialization of the window to execute the triggered operations until the times designated by the **[Repeat Times]** reach. This function is basically the same as the **All time** mode.

Close Frame:

The timer is triggered only once when the window closes.

Triggered by Register State:

The timer will be triggered according to the setting of the **Trigger State** and the value of the register designated by **[Trigger Address]**. When the **[Repeat time]** is 0, it will continue to execute the triggered operation until the trigger condition is cancelled. If the **[Repeat time]** is N, it will clear trigger register once triggered, and then trigger N operations before it automatically stops.

[Execution Cycle]: The timing cycle of the timer, in the unit of 100 ms. The timer will execute the triggered operation at an interval of the execution cycle.

[Response Mode]: Determines whether to execute the operation immediately or delay in execution. Executing immediately means it will be triggered immediately when the trigger condition is satisfied. Delayed execution means it will be triggered after the delay of an

execution cycle once the trigger condition is satisfied.

[Response State]: Determine whether to trigger the timer by the value of ON or OFF when it is triggered by the register.

[Repeat Times]: Means the number of repeated operations after the timer is triggered. Refer to the description of the execution times for each trigger mode. If the Repeat Times is set to 0, the timer will be triggered whenever the condition is satisfied.

[Trigger Address]: Address of the register to execute corresponding functions when the timer is triggered by the register (Note that the address must be a LB address).

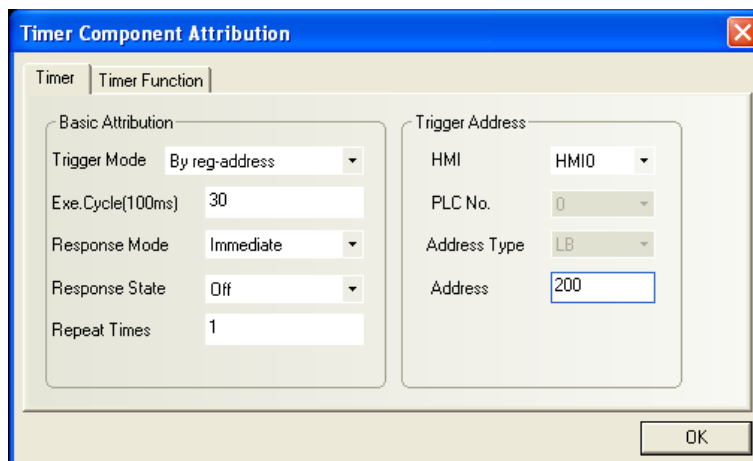

2. Go to the **[Timer Function]** tab:

There are three function blocks: **Execute Macro**, **Data Transfer** and **Set Satus**

(1) **Execute Macrocode:** The macrocode to be executed each time when the timing time arrives.

(2) **Data Transfer:** Implement data transfer function when the timing time arrives and transfer data of corresponding length from the source address to the destination address.

Source Address: Starting address of the register containing the data to be transferred

Destination Address: address of the transfer destination register

Data Type: Select to transfer data of bit or word type.

Data Transfer Length: Length of the data to be transferred (number of the bits or words)

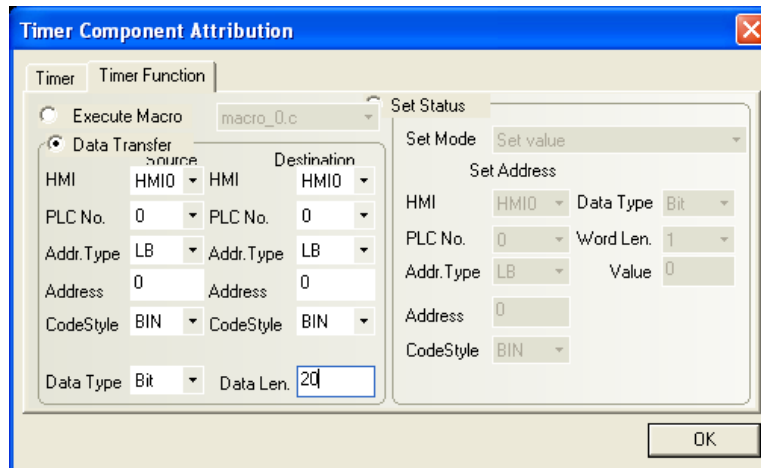

(3) **Set Status:** Set specific register value when the timing time arrives.

Set Address: address of destination register to be set when the timing time arrives

a. *Set the bit register:*

Set Mode: **Set value** and **Periodic Toggle**, as shown in the figure below:

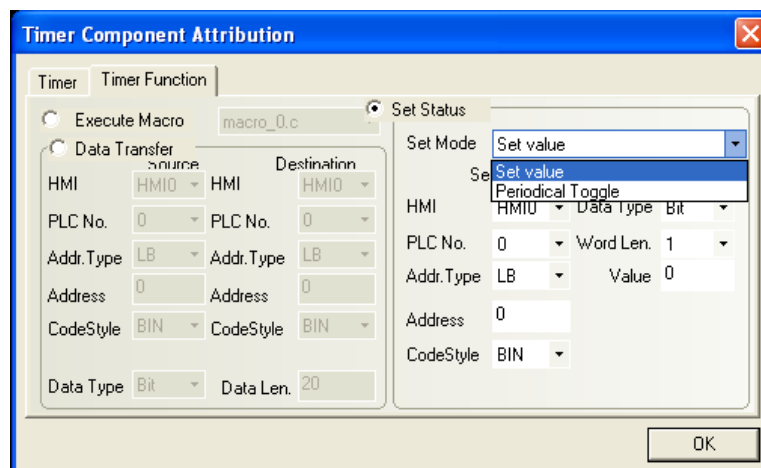

Detailed description of different functions is as shown in the table below:

Type	Description
Set Value	Set the designated bit register to 0 or 1 when the timing time arrives.
Periodic Toggle	The value of the designated bit register flips its status(ON/OFF) when the timing time arrives.

b. *Set word register:*

Set Mode: **Periodical JOG++**, **Periodical JOG--**, **Periodical Bounce**, **Step up**, **Step down**, and **Set Constant value**, as shown in the figure below:

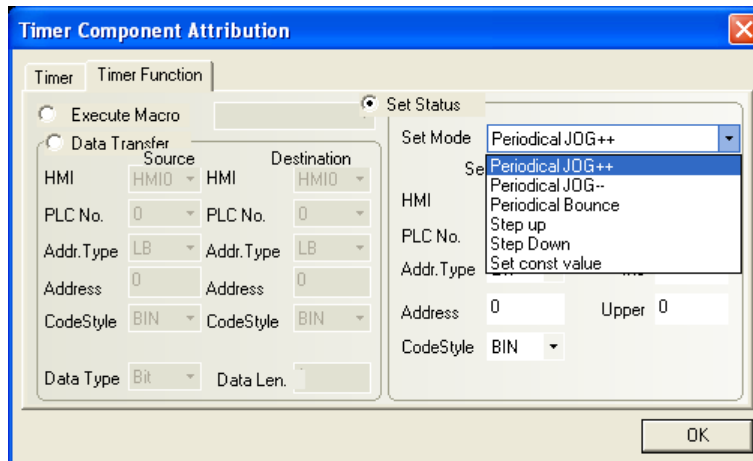

Detailed description of different functions is as shown in the table below:

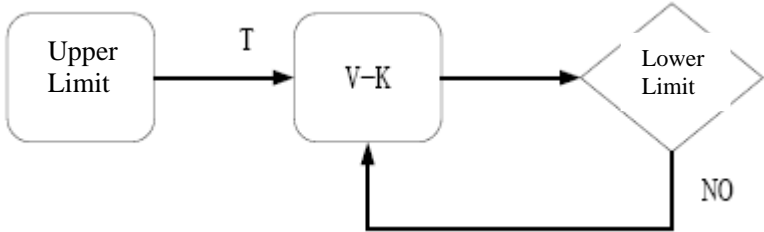
Type	Description
<p>Periodical JOG++</p>	<p>Automatically the incremental value is added to the current value of the designated PLC word register in every interval. The interval is defined in Execution Cycle. When the value reaches the upper limit, it starts at 0 again.</p>
<p>Periodical JOG--</p>	<p>Automatically the subtracted value is subtracted to the current value of the designated PLC word register in every interval. The interval is defined in Execution Cycle. When the value reaches the lower limit, it stops at the lower limit.</p> 
<p>Periodical Bounce</p>	<p>The operation becomes active when the window is open. The incremental Value is added to the current value of the designated PLC word register at regular intervals as specified by the Execution Cycle until the Upper Limit is reached. Then the incremental value is subtracted from the designated PLC word address until zero is reached. This cycle is repeated unconditionally.</p>

<p>Step up</p>	<p>The operation becomes active when the window is open. At every break time interval the value in the designated PLC word register is added 1 until upper limit reach. After then the value is reset to its lower limit and start again.</p>
<p>Step down</p>	<p>The operation becomes active when the window is open. At every break time interval the value in the designated PLC word register is subtracted 1 until lower limit reach. After then the value is reset to its upper limit and start again.</p>
<p>Set Constant</p>	<p>When the component is pressed, preset constant data is written to the designated PLC word address. (Enter the constant in the “Set Value” box.)</p>

3. Click **[OK]** to complete the setting and adjust the position and size of the timer component.

6.31 Video Components (Only Applicable to MT5600T/MT5700T)

Video components are used for real-time emonitoring. They can be used for real-time monitoring on industrial fields.



1. Click the **Video** icon, drag it to the window, and the **[Basic Attribution]** tab of the **[Video Component Properties]** dialog box appears.

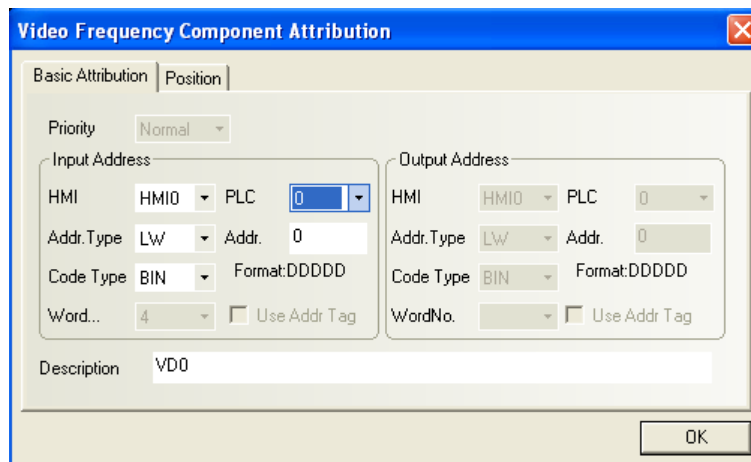

[Input Address]: Four consecutive word registers are used for save parameters of the **Video Component**. The [Input Address] indicates the starting address of those word registers. The first word indicates channel switching (the two channels are Channel 0 and Channel 1), the second word indicates brightness adjustment (adjustable range: 0 ~ 255), the third word indicates the contrast adjustment (adjustable range: 0 ~ 255), and the fourth word indicates chroma adjustment (adjustable range: 0 ~ 25).

[Address]: The starting offset address of the word register corresponding to a video component.

[Code Type]: BIN or BCD.

[No. of Words]: This cell is automatically filled with 4, the user can't change it..

[eUse Address Tag]: Whether to use the address entered in the address tag. For details, refer to Section 6.35.

[Description]: A reference name (not displayed) that you assign to the video component.

2. Go to the **[Position]** tab, and adjust the position and size of the video component if necessary.

Note: Video components can only be placed in a pop-up menu. They should not be placed in the base window.

For the window where the video component is located, the **[Video Page]** option in the **[Window Attribution]** dialog box should be selected.

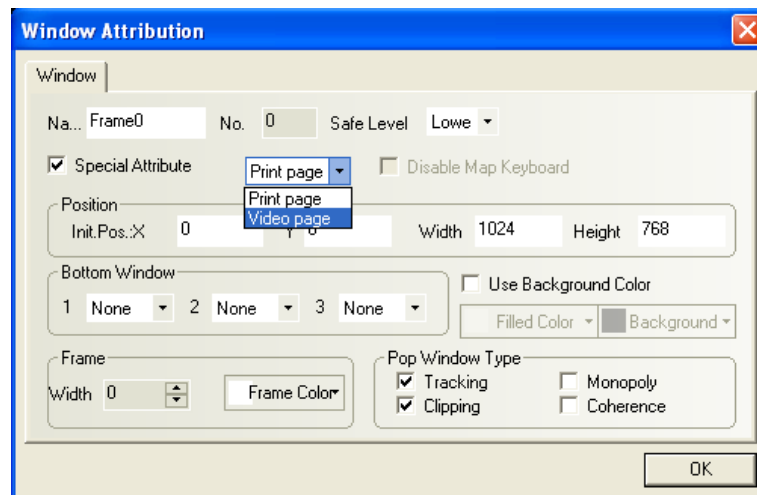

◆ An example for using Video Component

1. Create a new project. Select MT5600T or MT5700T as the HMI. Any PLC type in the PLC list is supported and can be used. In this example, we select FACON FB.

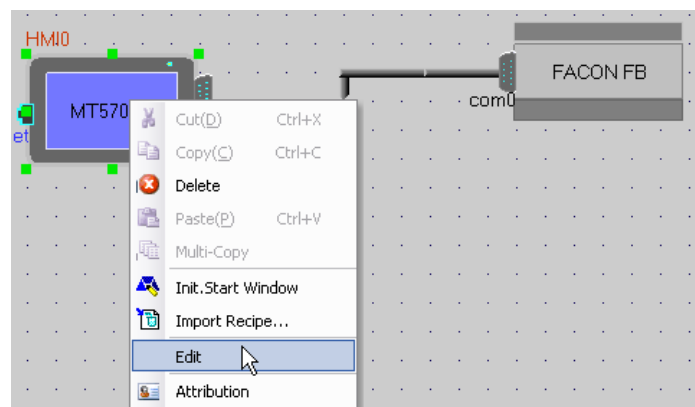

2. Place a function key in Window 0, and select pop-up **Frame4**.

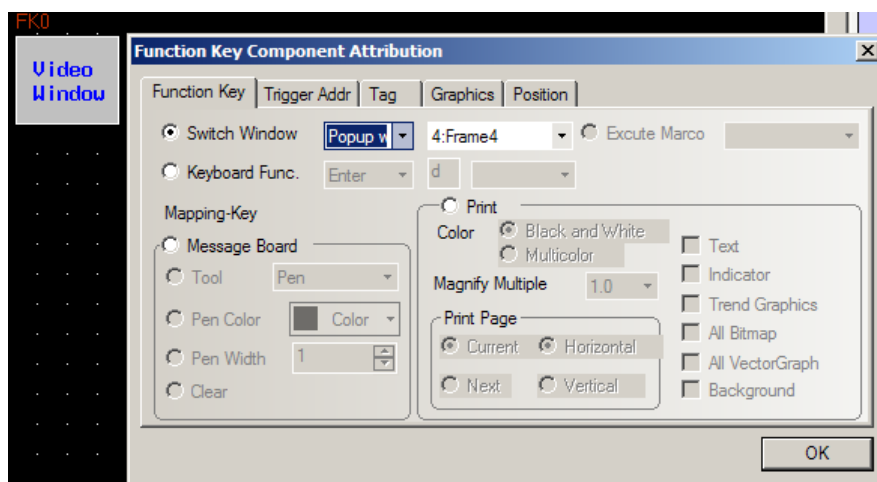

3. In Frame4, place a video component, with the input address type set to LW, the address to “0”, change the size of the window to 700 in width and 474 in height in the [Position] tab.

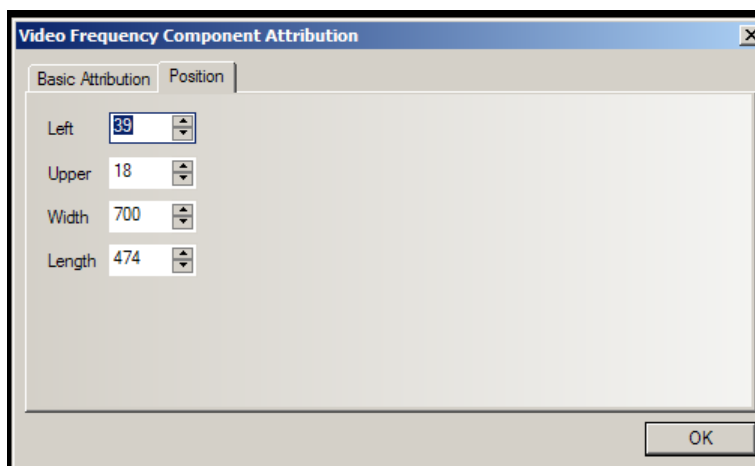
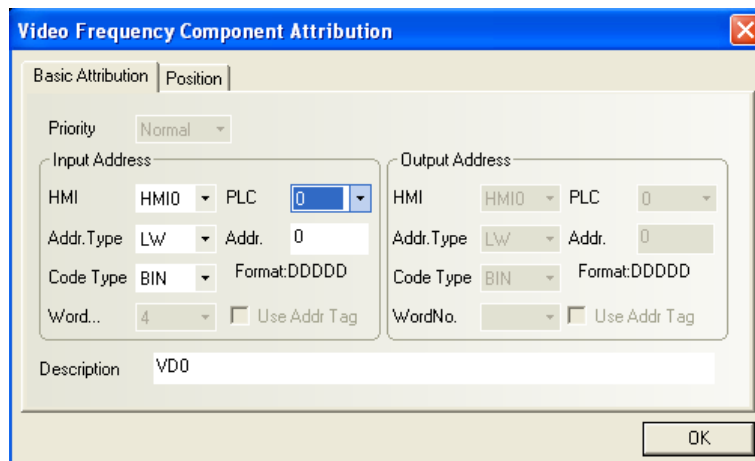

4. Place a word setting component, with the output address type set to LW, the address to “0”, the [Setting Mode] to [Add Value], the [Inc Value] to “1”, the [Upper Limit] to “2” (since there are only two video channels for switching), and the [Tag] set to “Channel+”.

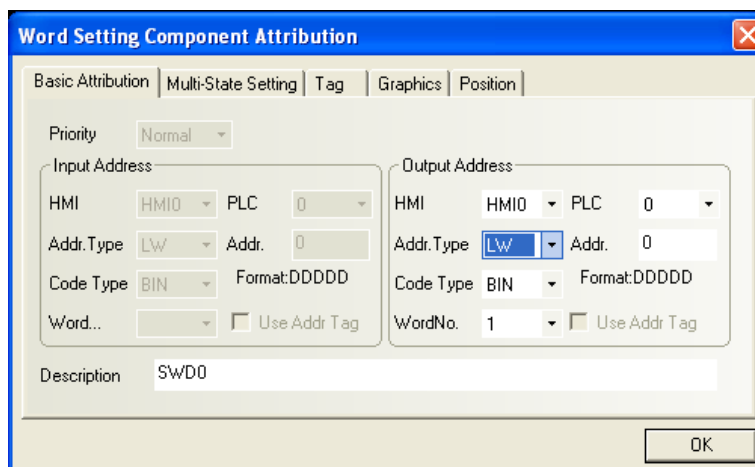

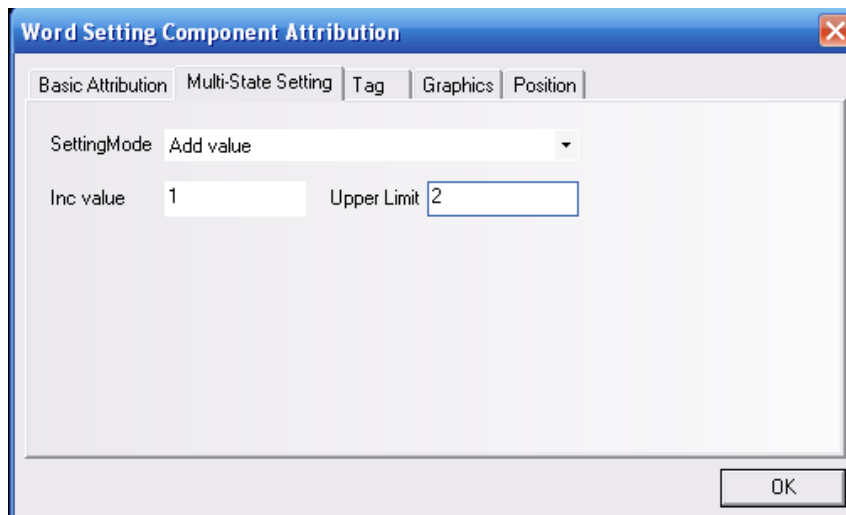

e

5. Place a word setting component, with the output address type set to LW, the address to “0”, the **[Setting Mode]** to **[Sub Value]**, the **[eDec value]** to “1”, the **[Lower Limit]** to “0”, and the **[Tag]** to “Channel-“.
6. Place a word setting component, with the output address type set to LW, the address to “1”, the **[Setting Mode]** to **[Add Value]**, the **[Inc Value]** to “8”, the **[Upper Limit]** to “255” (value range: 0~255), and the **[Tag]** set to “**Brightness+**”.
7. Place a word setting component, with the output address type set to LW, the address to “1”, the **[Setting Mode]** to **[Sub Value]**, the **[Dec value]** to “8”, the **[Lower Limit]** to “0”, and the **[Tag]** to “**Brightness-**“.
8. Place a word setting component, with the output address type set to LW, the address to “2”, the **[Setting Mode]** to **[Add Value]**, the **[Inc Value]** to “8”, the **[Upper Limit]** to “255” (value range: 0~255), and the **[Tag]** set to “**Contrast+**”.
9. Place a word setting component, with the output address type set to LW, the address to “2”, the **[Setting Mode]** to **[Sub Value]**, the **[Dec value]** to “8”, the **[Lower Limit]** to “0”, and the **[Tag]** to “**Contrast-**“.
10. Place a word setting component, with the output address type set to LW, the address to “3”, the **[Setting Mode]** to **[Add Value]**, the **[Inc Value]** to “8”, the **[Upper Limit]** to “255” (value range: 0~255), and the **[Tag]** set to “**Chroma+**”.
11. Place a word setting component, with the output address type set to LW, the address to “3”, the

[Setting Mode] to **[Sub Value]**, the **[Dec value]** to “8”, the **[Lower Limit]** to “0”, and the **[Tag]** to “**Chroma-**”.

12. Place a function key component, and set it as a “pop **window title bar**” (See 6.29 for details).
13. Place a function key component, and set it as a “minimize window” (See 6.29 for details).
14. Place a function key component, and set it as a “close window” (See 6.29 for details).

The completed window 4 is shown as follows:

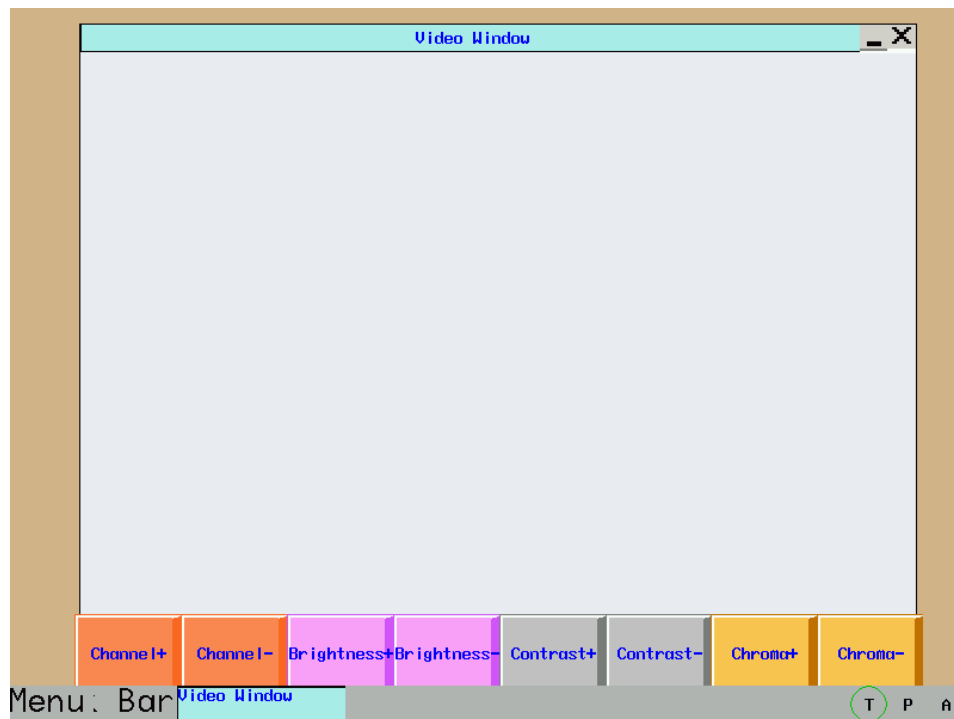

Install a camera properly, download the project to the HMI, click **[eChannel+/Channel-]** to switch between channels 0 and 1, click **eBrightness+/Brightness-** to adjust the brightness, click **[Contrast+/Contrast-]** to adjust the contrast, and click **[Chroma+/Chroma-]** to adjust the chroma, so as to achieve the best camera effect. Click the Window Bar, and the entire window can be moved. You may select to close or minimize the window.

Note:

1. The video component window does not support offline simulation, indirect online simulation and direct online simulation.
2. The video window runs above the base window all the time.

6.32 Bitmap Component

Bitmap components are used static image as illustration or background. With this component, you can place images already imported into the bitmap library onto configuration window. For details about importing image to bitmap library, please refer to Section 5.6. The EV5000 supports the display of images in 65535 colors. It can display beautiful and vivid color pictures so that your operator interface looks more beautiful and pleasant.

How to add a bitmap component to the window:

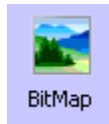

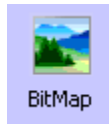
1. Click the  icon and drag it to the window. Select a bitmap you want to use from the drop list, as shown in the following:

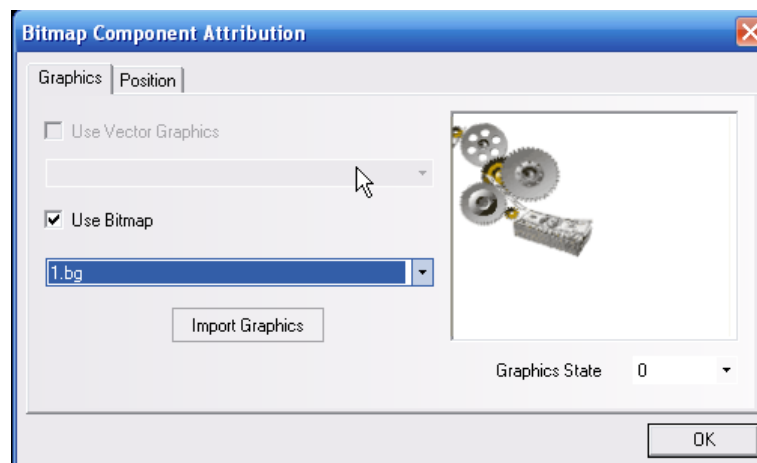

2. Click **[OK]**, adjust the position and size of the bitmap in the window if necessary.
3. For details about importing an image to a bitmap library, please refer to Section 5.6.

6.33 Vectogram Component

Vectogram Component is similar to **Bitmap Component**. You can directly place any vectograms already in the vectogram library in the window, without the need to designate any components.



1. Click the  (Vectogram) icon and drag it to the window. Select the vectogram you want to use from the drop-down list, as shown in the following figure:

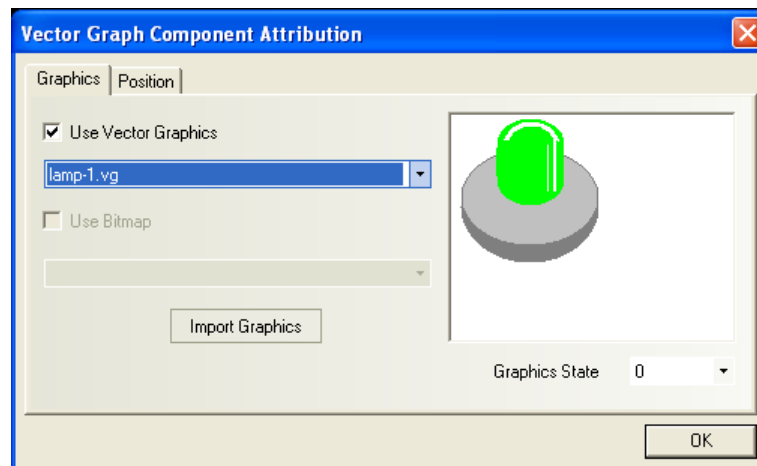

2. Press **[OK]**, and adjust the position and size of the vectogram in the window if necessary.
3. For the creation of a vectogram, please refer to Section 5.6.

6.34 Text Library

The text library is a database for storing text contents, which can be used as tags of components. Text stored in the **[Text Library]** can be used for multiple components. In this way, repeated text input can be avoided. To use text in the library, select the check box **“Use Text Library”** in the **[Tag]** tab of the **[Component Attribution]** dialog box and select the text content you want to use. One of the greatest features of the Text Library component is the multi-language column feature. Each text entry in the library has four columns, where user can input the same text content in four languages. The user can change the column being displayed by changing a system reserved register, LW9130. The usage of **[Text Library]** is discussed in detail in this section.

Enter text content to the librarye

1. Click the  icon or select **[Project Database]→[Text Library]**, and the text object library appears:

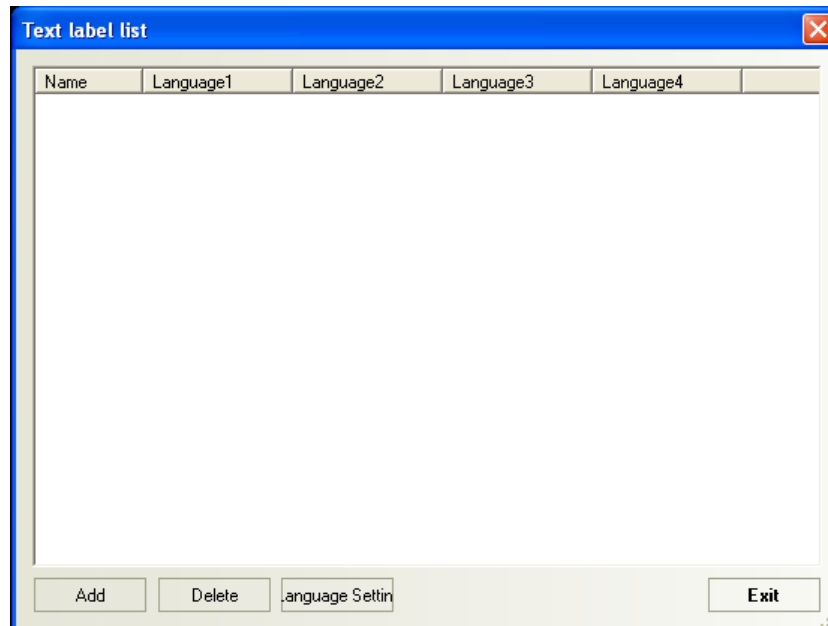

2. Then press **[Add]**, and the following text input dialog box appears. Enter **[Name]** and **[No. of States]**, and click **[OK]**.

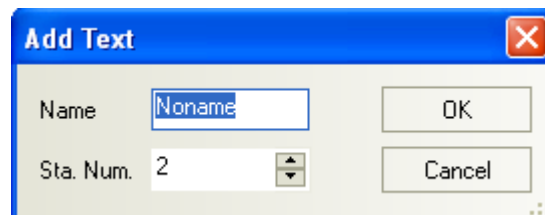

3. In this case, the text is added to the text library. Press the symbol “+” after the **[Name]**, and the following figure shows the set **[No. of States]**.

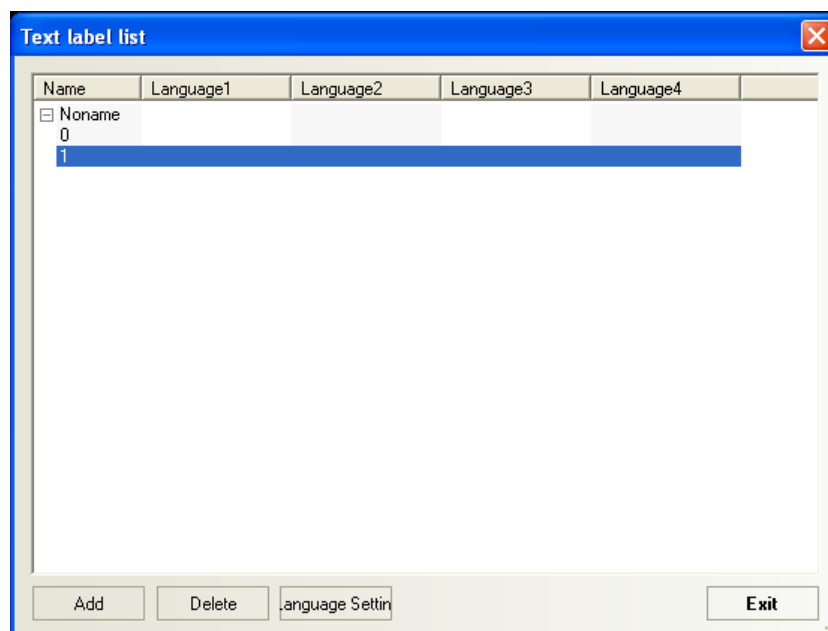

- Then, enter characters for each state, as shown in the following figure:

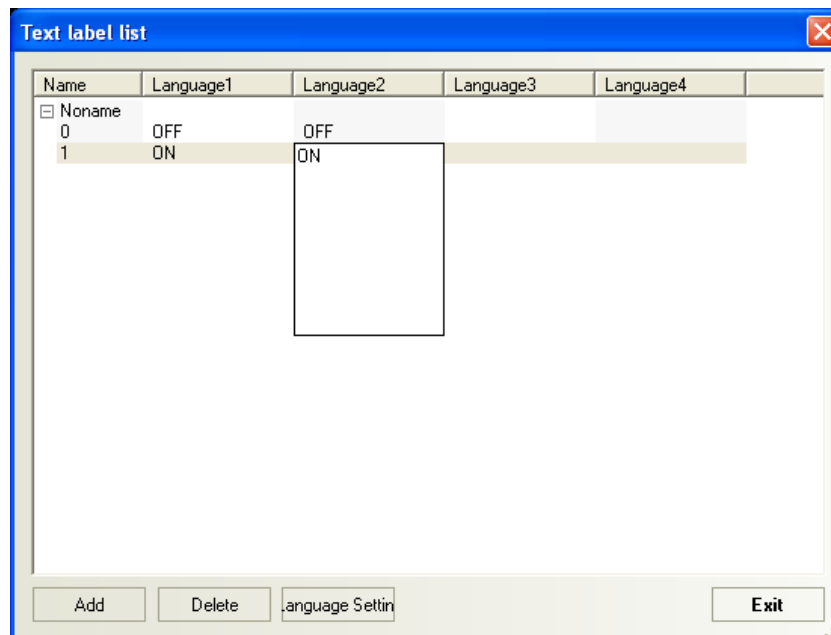

- If you use two states, enter the corresponding characters in State 0 and State 1. After adding the text, click **[Exit]**.

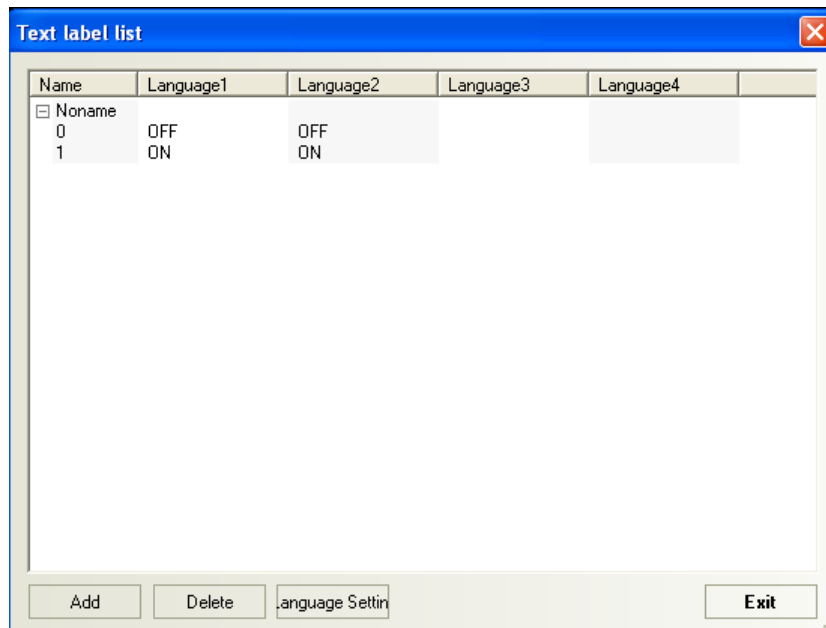

- Finally, you can use the previously added text in places where the **[Use Text Library]** can be used, shown as follows:

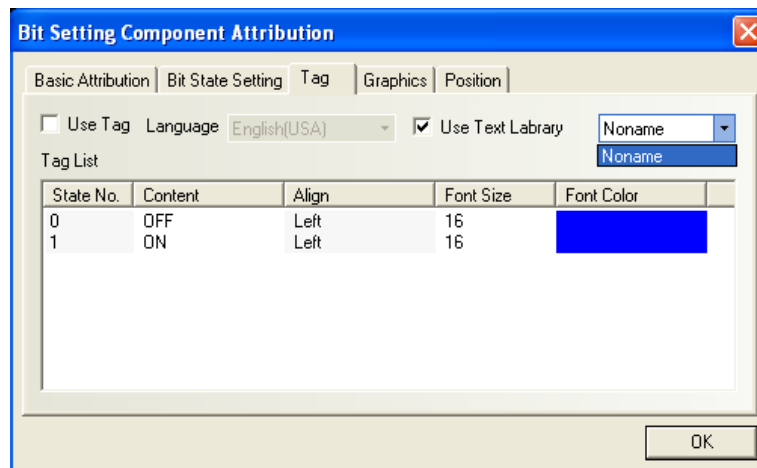

If have not added any text to the text library, the **[Use Text Library]** is not activated and in grey all the time. It is enabled only when you have added a text.

2. Language Setting

e

The languages corresponding to different values of the LW9130:

- LW9130=0: Language 1** Contents in the “Language 1” column will be displayed.
- LW9130=1: Language 2** Contents in the “Language 2” column will be displayed.
- LW9130=2: Language 3** Contents in the “Language 3” column will be displayed.
- LW9130=3: Language 4** Contents in the “Language 4” column will be displayed.
- LW9130>3: Language 1** Contents in the “Language 1” column will be displayed.

Therefore, you can place some word setting components in the main interface to set the value of the LW9130, the tags of those word setting components indicate the language they stand for. Touch the word setting component corresponding to the desired language after the HMI panel has just powered on, so that the user can select appropriate interface language. To change the language, return to the main interface to select the language again. e

6.35 Address Tag

Address tag is a list for storing frequently used register addresses. It also saves a lot of time for the user, avoiding the trouble of reentering an address. You can use the address in the list in any place that supports the application of **[Use Address Label]**.

Its usage is described as follows:

Create an address tag in the Tag Library

1. Click the  icon or select **[Project Database] → [Address Label]** on the toolbar, the address label library appears:

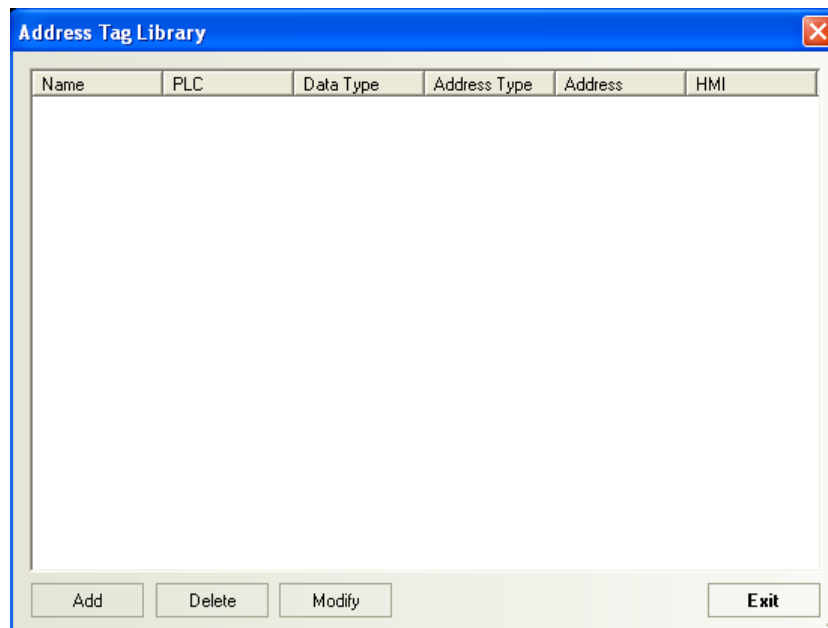

2. eClick **[Add]**, the following small dialog box titled “**Build Address Tag**” appears:

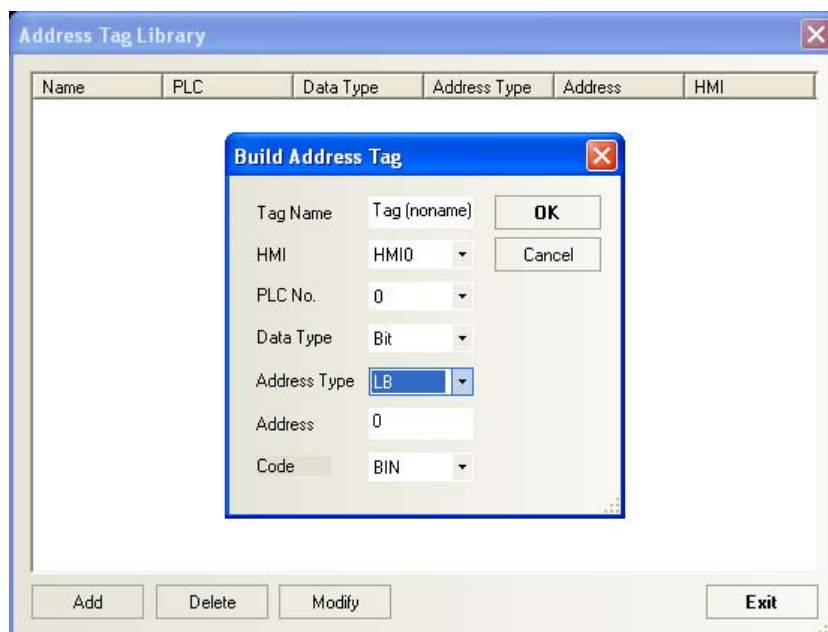

Tag Name: Enter the name you assign to the address label. A meaningful name can help the user recognize the purpose of that register. It is very useful when select address tags from list.

HMI: Select the HMI panel corresponding to the tag.

PLC No.: Select the PLC station number corresponding to the tag.

Data Type: Select whether the tag is a **Bit** or a **Word** register.

Address Type: Select the address type corresponding to the tag: address types of the register vary with the type of PLC

Address: The address of the tag.

Code: The type of code of the data, BIN or BCD.

3. Enter the proper values for the above parameters, click **[OK]**, and the address tag entry will appear in the library:

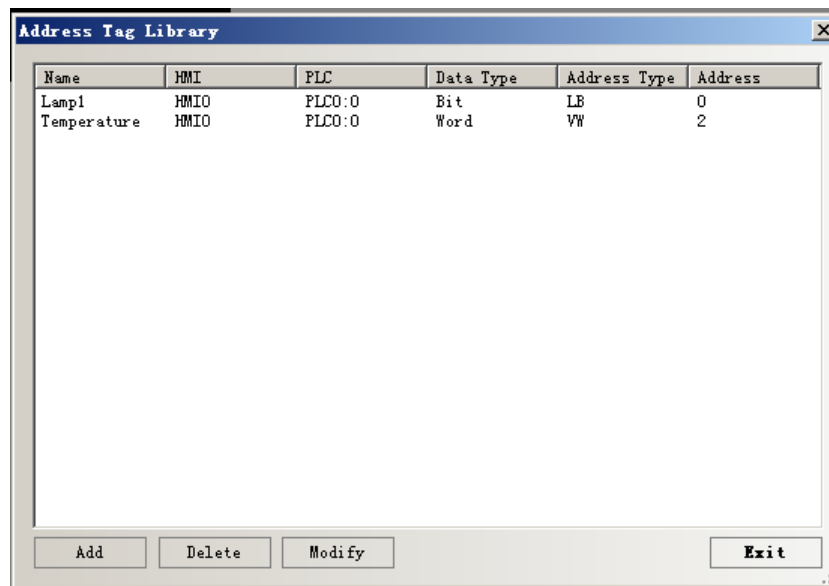

Using address tags

Select a component, open the **[Component Attribution]** dialog box, check the **[Use Addr Tag]** option and select the desired tag in the **[Addr. Type]** drop down list:

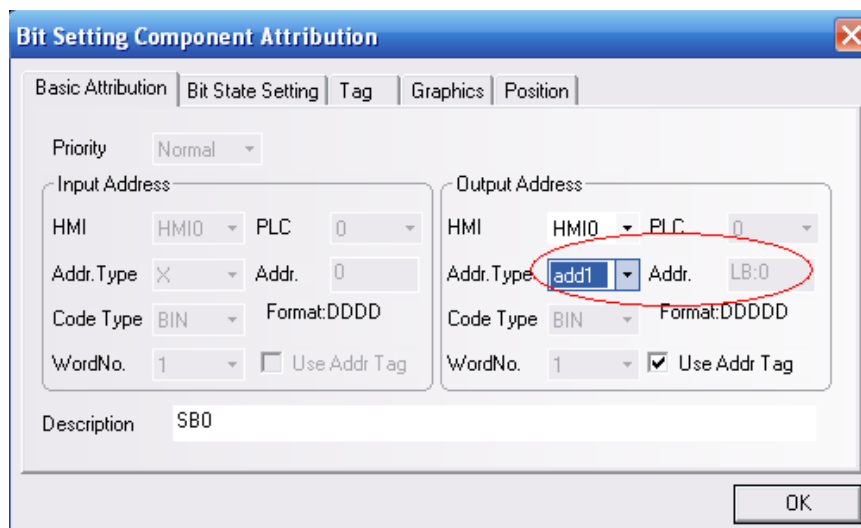

An address tag entered in the tag library cannot be changed in other places. To change it, the user must open the address tag library and do the desired operation.



Note: The data type of the component using address tag **MUST BE CONSISTENT WITH** the type of the tag. For example, when selecting a tag for a Bit component such as [bit lamp] or **[bit**

switch], only the tags of Bit type can be seen in the [Addr. Type] list. When selecting a tag for a Word component such as **[word setting component]** or **[multiple state display]**, only the Word tags can be seen in that list.

6.36 PLC Control

PLC Control is a list storing the PLC register events. Registers in the list are linked to specific functions. These functions are controlled by the value of corresponding registers. Functions supported by PLC Control library is listed in the following table. Once the “Register-Control” pair is logged in the list, it will automatically run like a background program.

Change window	To change the current window
Backlight control	To Turn on/off the backlight
Screen print	To print the current screen
Report print	To print the content of the designated window
Backlight control (return value)	Backlight control with return value
Universal PLC control (data transmission)	To implement data transmission between the PLC address and the LW/RW
Execute macro	To execute related macro instructions when the conditions are satisfied

► The process for creating a PLC control component

1. Click the **[PLC control Library]** icon , the **[PLC Control Object List]** appears.

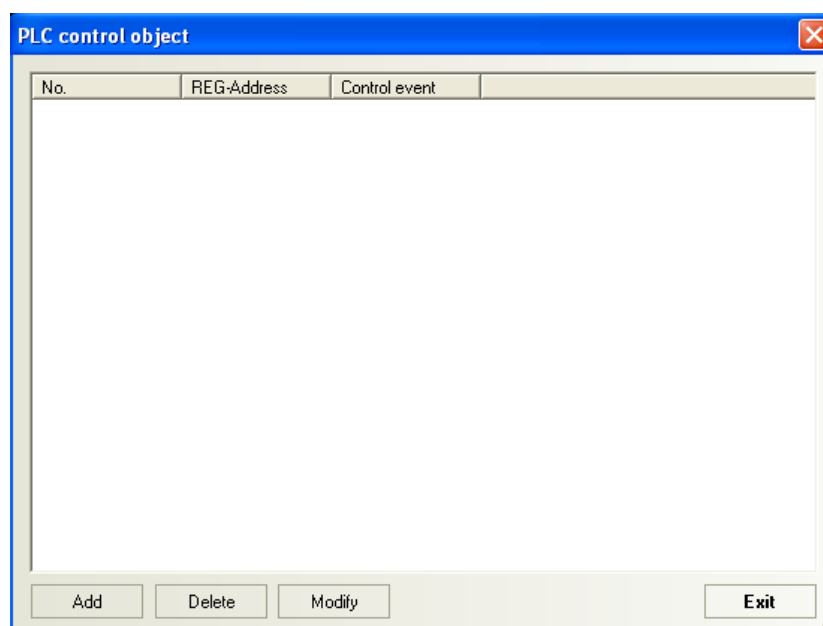

2. Click [Add] to create a new PLC control entry. Click [Modify] if you want to modify the PLC control entry, and by clicking [Delete], you can delete the selected entry.
3. Correctly fill in the contents in the PLC control component dialog box.

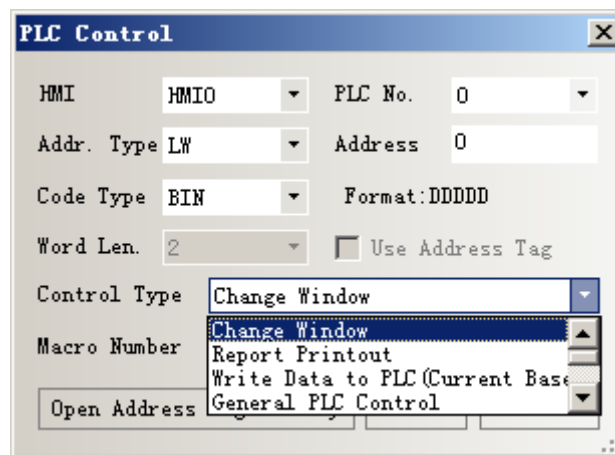

Address Type: Designate the address type of the register to conduct these PLC control operations.

Address: Designate the address of the register to conduct these PLC control operations.

Code Format: BIN or BCD.

Control Type: Designate the operation behavior. The following operations are supported: [Change Window], [Report Printout], [Write data to PLC (Current Base Window)], [General PLC Control], [Back Light Open/Close (With or without Write back)], [Screen Hardcopy], and [Execute Macro Program]. Their functions are described later.

Macro No.: It refers to the number of the macro code to be executed when the [Control Type] is set to [Execute Macro].

4. Click [OK] to exit the PLC control component dialog box.
5. Click [Exit] again to exit the [PLC Control Object List].

Change eWindow

This operation needs the use of two consecutive word registers. When the register corresponding to the **Input Address** (address specified in the PLC Control dialog box) is changed to a valid window number, the current window will be closed, and the designated window will be displayed. The number of this designated window is read from the register of the [Input Address]. Then, that number will be written to the (Input Address) +1 register of the PLC.

Input address	Designate the target widow number
Input address + 1	Write the target window number here

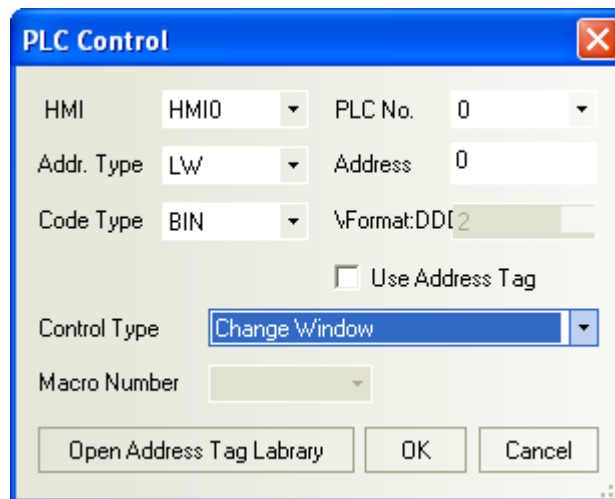

As shown in the above figure, we use LW0 to change window. Assume that the current window is Window 0. If LW0 changes to “4”, the current screen will change to Window 4, and then the value “4” will be written back to register LW1.

Notes on “Change Window” function:

The **[Change Window]** operation carried out by the **PLC control** is similar to the **[Change Window]** operation carried out by **Function Key** component. The only difference is that it is triggered by the PLC register, instead of the touch operation. If the value of the **[Input Address]** register changes to a new valid window number, the current window will be closed, and the window designated by the **Input Address** will be displayed. Then, that number will be written into back to the register located at **Input Address+1**. This operation will be triggered only when the value of the **[Input Address]** changes. Only one screen change can be made every time when the value is changed once.

Report Printout

This operation is used to control the printout of a designated window by use of a **WORD** register. If the content written into this word address is a valid window number, the content of the window will be printed out. However, during the print, the window will not be changed to the printed window. Please refer to the descriptions of “**Report Printout**” in Chapter 10.

Write data to PLC (Current Base Window No.)

This function make the panel write the window number of the current basic window to a designated register. In this way, the PLC can know which window is currently displayed on the panel.

Note: When the current basic window is changed, the touch screen will automatically send the number of the new basic window to the designated word register.

General PLC Control

The **General PLC Control** function is used to control the data transmission between the PLC and the touch panel with PLC data registers.

There are four transmission mode:

1. **PLC > RW (recipe data memory), with the type code of 1**
2. **PLC -> LW (local data register of the touch screen), with the type code of 2**
3. **RW (recipe data register) ->PLC, with the type code of 3**
4. **LW (local data register of the touch screen) -> PLC, with the type code of 4**

The detailed descriptions are as follows:

Select [**General PLC Control**] for the [**Control Type**] in the PLC control component setting dialog box, and select the type and address of the control data register in the [**Input Address**] column, which should be in units of words. The system will automatically set the four consecutive PLC data registers starting from the [**Input Address**] to be [**Data Transmission Control Register**] for controlling the data transmission. Their detailed meanings and usage are as follows:

1. [**Input Address**]: It indicates the transmission mode. As mentioned above, there are four modes. This register is used to store the codes of the control type. When new control codes are written into the register, the system will immediately execute related transmission. After the transmission is completed, the register will reset to "0".
2. [**Input Address +1**]: It indicates the size of the transmitted data block, that is, the number of words to be transmitted.
3. [**Input Address +2**]: It indicates the offset of the data register address of the PLC during transmission. Please note that this offset is referred to register located at [Input Address+4] as its reference origin. For example, suppose that we use a MODBUS PLC, If the [**Input Address**] set for the [PLC General Control] component is 4X100, and the data in the register "4X102" is 4, the start address of the data block in the PLC during the transmission is $4X108=[(100+4)+4]$.
4. [**Input Address+3**]: It indicates the address offset of the recipe register (RW) or the local data register (LW) of the touch screen during transmission. The offset is referred to "0". For example, in the above example, if the data of the register "4X103" is "100", the start address of the data block in the touch screen during the transmission is $RW(LW)100=(0+100)$.

Application examples:

Suppose that we need a PLC to control the transmission of 30 words from registers starting with "4X10" in the MODBUS PLC to the data block of the same size starting from RW200 in the recipe memory of the touch screen. The implementation is described as follows:

1. Designate four data registers starting with DM10 to be used to control data transmission. Thus, first we need to input an entry of **PLC control component** to the **PLC Control Library**, select "**General PLC Control**" for the type, and set the **Input Address** to 4X10.

2. Next, determine the data block size and the address offset. Set “4X11” to “30”, indicating that the size of the transmitted data block is 30 words. Set “4X12” to “86”, indicating the source start address of the operation is “4X100=(14+86)” of the PLC. Set “4X13” to “200”, indicating the destination address is RW200=(0+200).
3. Finally, based on the data transmission direction, set the transmission type code to execute the transmission process. “4X10” should be set to “1”, indicating that the data of the PLC data block with the set start address will be transmitted to the data block of the recipe memory of the touch screen with the set start address. If “4X10” is set to “3”, the transmission direction is opposite.

Likewise, the transmission operations in the other two directions are the same, and the only difference is that the data memory of the touch screen is changed to the local data register (LW).

Backlight Close

This function can be used for closing panel backlight with a bit register. When the specified Bit register state is ON, the backlight of the panel will be shut off. Even if the Bit register is set OFF, the backlight will not resume. To use a PLC Bit register to light up the backlight, use the **Backlight Open** function.

Backlight Close (return value)

This function is similar to the Backlight Close function we have just mentioned above. The only difference is that when selecting this type of Backlight Close, the control Bit will be automatically cleared after the backlight going off.

Backlight Open

This function can be used for opening panel backlight with a bit register. When the specified Bit register state is ON, the backlight of the panel will be turned on. Even if the Bit register is set OFF, the backlight will not go OFF. To use a PLC Bit register to shut off the backlight, use the **Backlight Close** function.

Backlight Open (return value)

This function is similar to the Backlight Open function we have just mentioned above. The only difference is that when selecting this type of Backlight Open, the control Bit will be automatically cleared after the backlight being turned on.

Screen Hardcopy

This operation is used to control the printout of the content of current screen by use of a bit address. If the bit register is triggered from “OFF” state to “ON” state, the current screen will be printed out. In the **[Print Settings]** interface that appears by selecting **[HMI]/[Properties]** in the

communication configuration interface, the valid printer type should be set. Please refer to the descriptions of “**Screen Hardcopy**” in Chapter 10.

Execute Macro Program

If the designated bit address state is “ON”, the selected macro will be triggered.

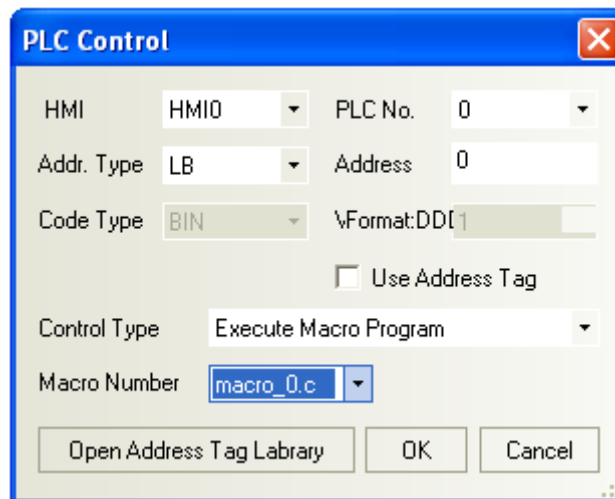

eAddress Type/Address: The address of the register triggering the execution of the macro instruction. If this bit is set to “1”, the macro code will be executed; if it is set to “0”, the macro instruction will not be executed.

Macro No.: The number of the macro code to be executed.



Note: This function can be used only when macrocodes are added to the project. For the adding of macrocodes, please refer to Chapter 9.

6.37 About Overlapping of Components

The overlapping of multiple components will generate many special functions. The MT5000 can support the overlapping of multiple components. If these overlapping components are touched, the program will execute related operations according to layer order of the individual components. The components in the topmost layer are considered to be touched first and the corresponding function will be conducted first, and then the second layer, and so on. For example, If six bit state setting change components are overlapped to respectively control register Y0 (the topmost layer) to Y5 (the bottommost layer), when these components are touched, the MT5000 will execute the program in the following order:

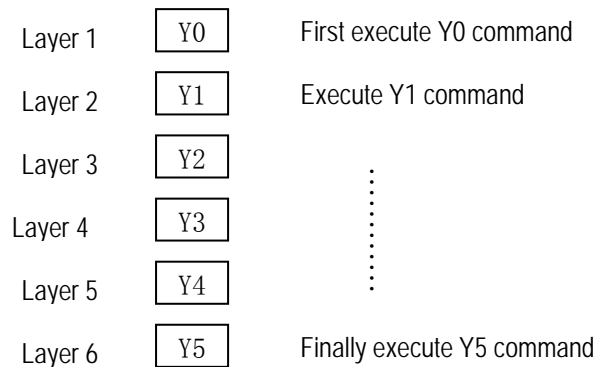

First reset the ON/OFF of Y0, and set control the ON/OFF of Y1 (step 2), set the ON/OFF of Y2 (Step 3), and so on, and finally, set the ON/OFF of Y5 (step 6).

Please note that, when the MT5000 encounters the **Change Window** command, it will bypass the following components and directly change to the target window. As shown in the following figure, if Y2 is a function key for **Change Window**, Y3 ~Y5 will be neglected. The number of overlapped components should not exceed 32.

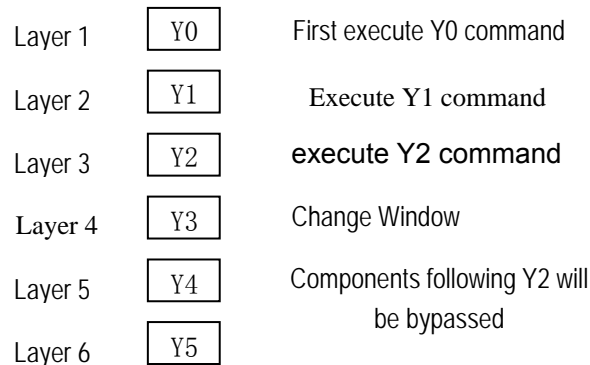

6.39 Notebook

Notebook Component is like the **Notebook Program** in the **Windows Operating System**. The user can input text contents in the component area. Operations such as Copy, Cut and Paste are supported. These functions are implemented by **Function Key** component.

The Notebook-Only functions of the Function Key are listed in the following figures:

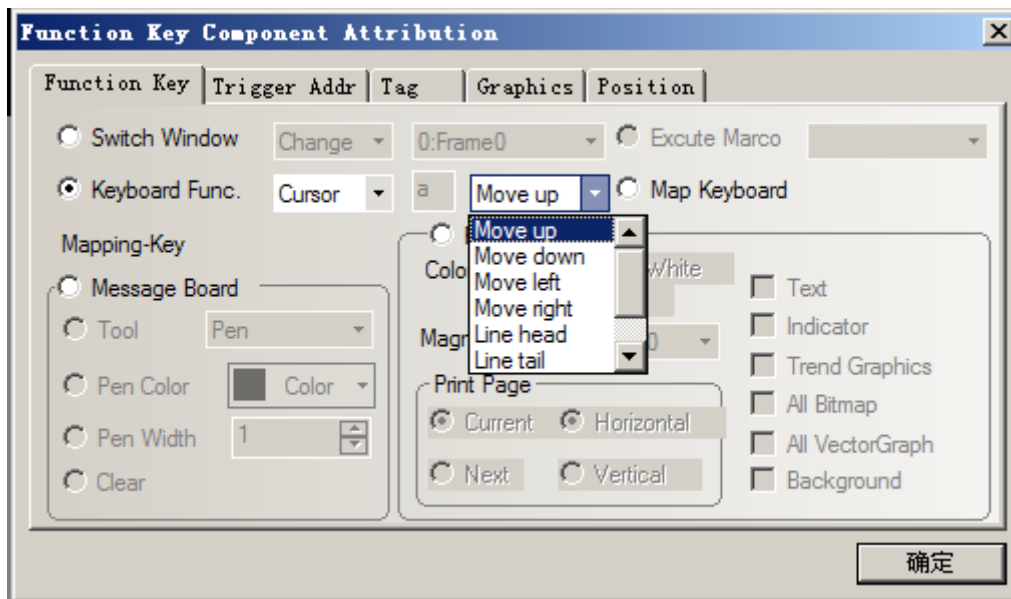

Figure 1 shows the functions related to move the cursor. There are eight functions: **[Move up]**, **[Move down]**, **[Move left]**, **[Move right]**, **[Line head]**, **[Line tail]**, **[First Position]** and **[Last Position]**.

Move up: move the cursor up to the previous line, if the cursor is on the first line, it will remain in current position.

Move down: move the cursor down to the next line, if the cursor is on the last line of the **Notebook**, it will remain in current position.

Move left: move the cursor left by one character, if the cursor is on the head of a line, it will move to the end of the previous line. If it is on the head of the **Notebook**, it will remain in current position.

Move right: move the cursor right by one character. If the cursor is on the end of a line, it will move to the head of the next line. If it is on the end of the **Notebook**, it will remain in current position.

Line head: move the cursor to the head of the current line. If it is on the head of the current line, it will stay there.

Line Tail: move the cursor to the end of the current line. If it is on the end of the current line, it will stay there.

First position: move the cursor to the first position of the **Notebook** component. If it is on the first position now, it will stay there.

Last position: move the cursor to the last position of the **Notebook** component. If it is on the last position now, it will stay there.

Note:

1. The Last position is the last position of the Notebook, not the last character of the current text content, in many cases, they are different.
2. To activate the cursor, touch the Notebook component on the panel to pop up the keyboard for input. The cursor will glitter to indicate the current position.

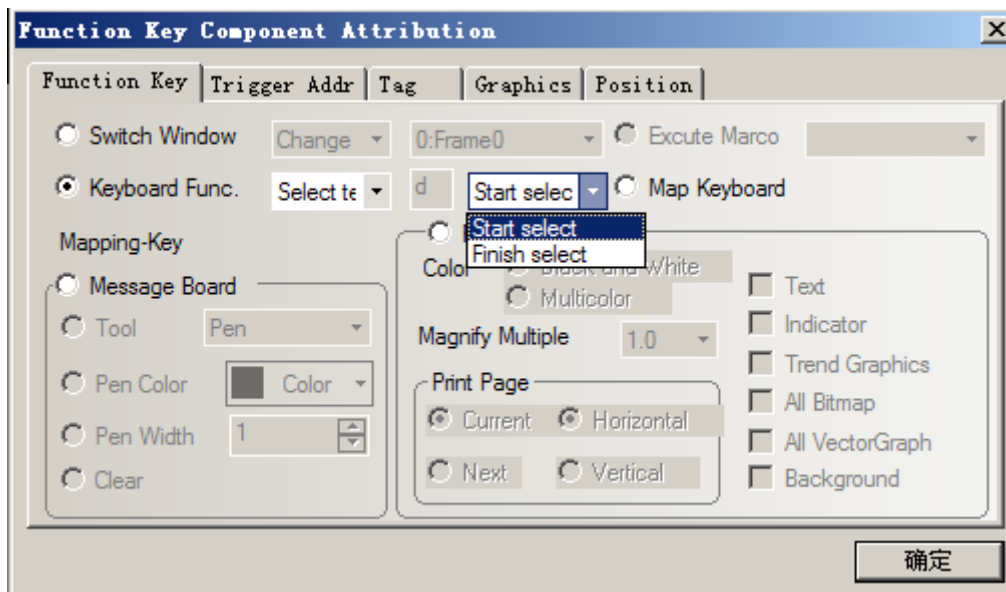

Figure 2 shows the functions related to Text Select operation: **[Start select]** and **[Finish Select]**.

Start select: After activate and move the cursor to the start of the text you want to select, touching this function key will confirm the start of the text being selected.

Finish select: After touching Start select, move the cursor to the end of the text content you want to select, then touch this function key to complete the select operation.

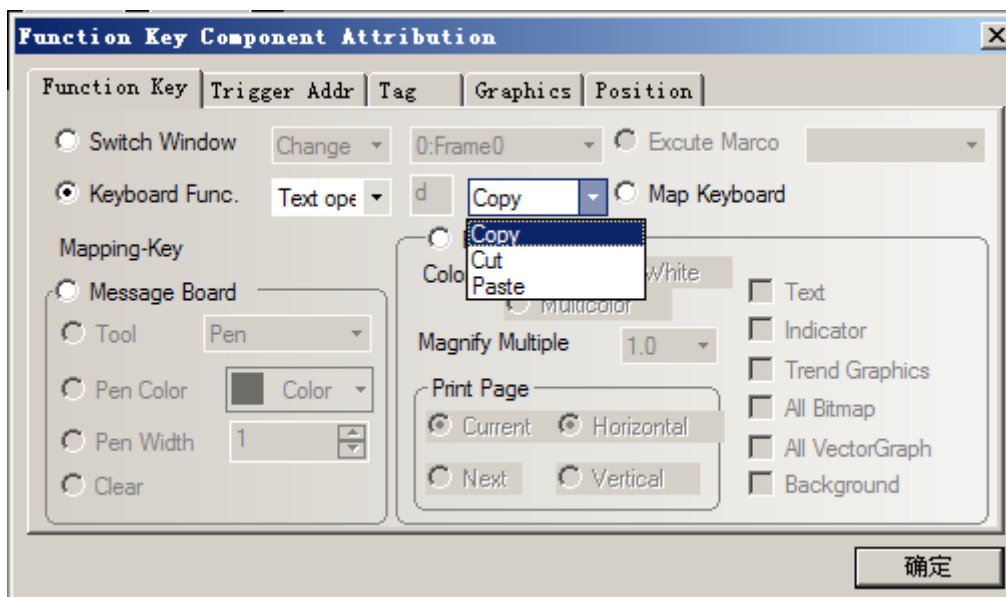

Figure 3 shows the functions related to text operation: **[Copy]**, **[Cut]** and **[Paste]**.

Copy: The selected text will be copy to the memory for future paste operation.

Cut: The selected text will be cut to the memory for future paste operation.

Paste: If there is any text stored in the memory, it will be pasted from the current cursor position. If the text exceeds the limit of the textbook, exceeding part will be truncated.

The following figure shows a project screen using a textbook component.



Attributions of Textbook Component

The Textbook Component has some special attributions, as the following figure shows:

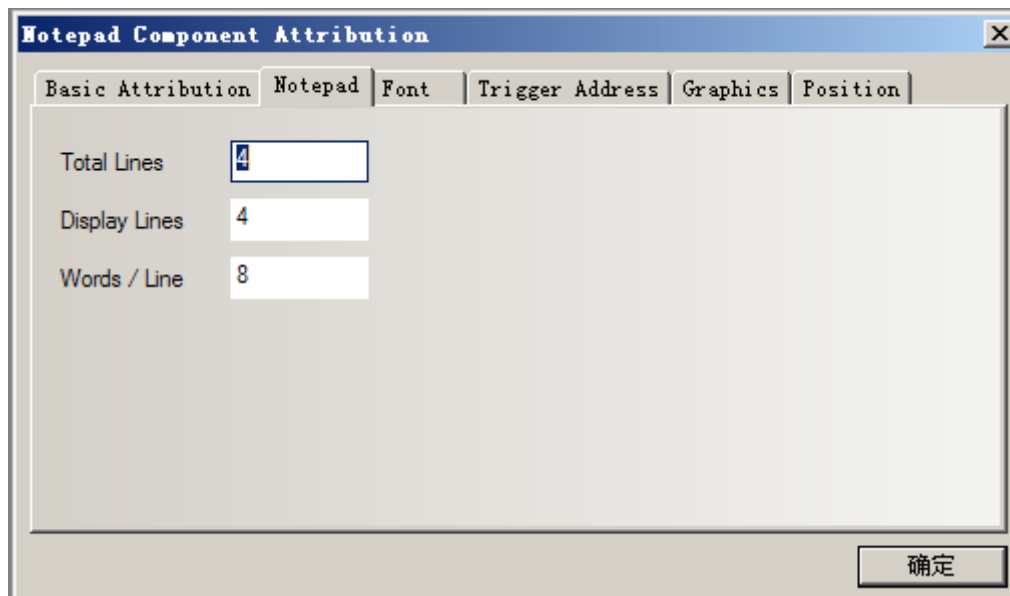

Total Lines: The value indicates the total of lines of the Notebook component.

Display Lines: This value indicates the number of lines displayed on the screen; the user can use LW9170 to scroll pages if the Display Lines value is less than the Total Lines value. The value of the LW9170 register indicates which line is displayed as the first line in the textbook input area. By changing the value, the user can scroll pages of the textbook component.

Words/Line: Number of words per line, must be an even number. A word corresponds to two ASCII characters.

Chapter 7 System Parameters

The panel attributions must be properly set before it can work. In this chapter, we introduce the setting of the HMI attribution setting dialog box, including the setting of taskbar, extensional attribution, printer setting and serial ports setting. These parameters are required for correct PLC connection and other operations.

Double click HMI icon in the configuration project window to show the HMI attribution dialogbox.

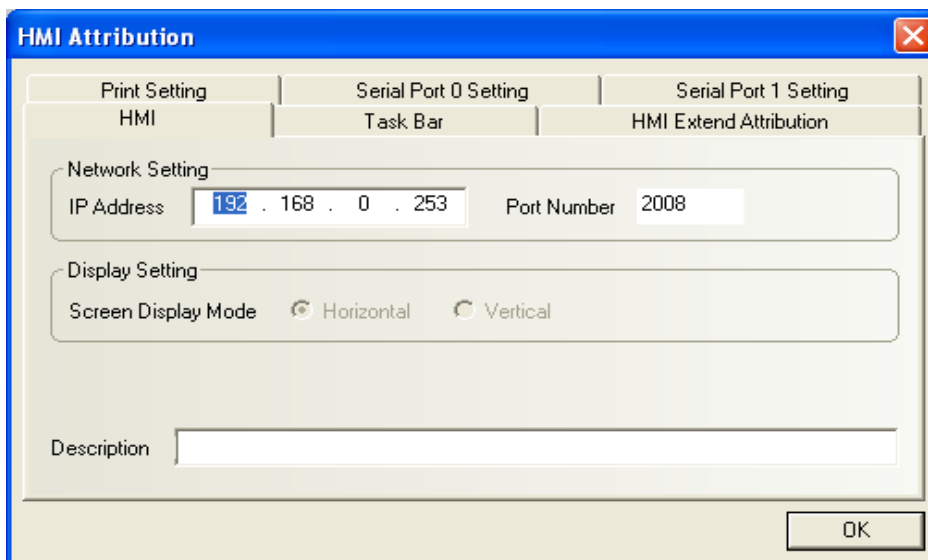

In the dialog box, there are six tabs, namely, HMI, **Taskbar**, **HMI Extend Properties**, **Print Settings**, **COM1 Settings** and **COM0 Settings**, as detailed one by one below.

7.1 HMI

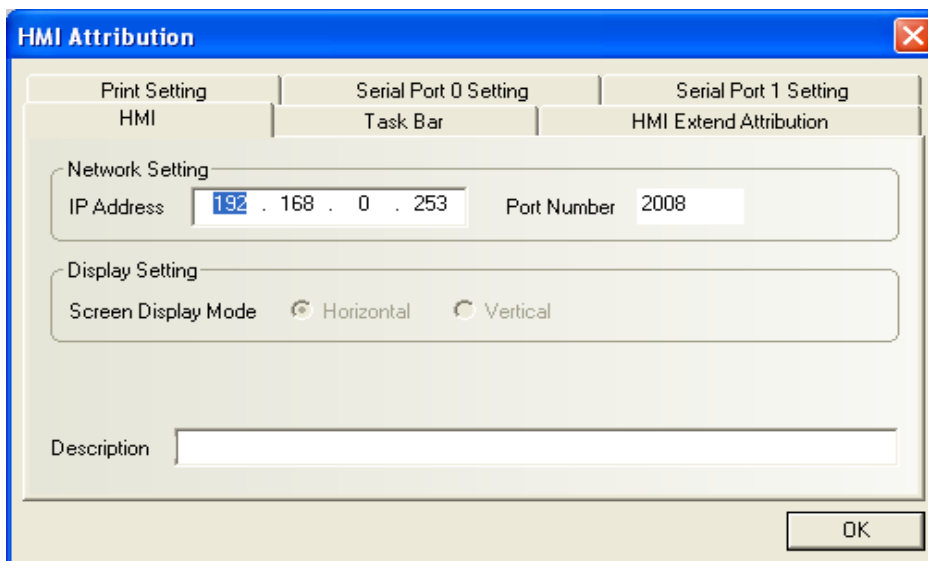

IP Address: Set the IP address of the HMI. This IP address is the IP address of the HMI when

the Ethernet connection is used. (IP Address is only valid for MT5000 and MT4000E, not for MT4000)

Port Number: Refer to the description in Section 3.9.

Display Settings: Select the display mode: **Horizontal** or **Vertical**. The display mode is set when dragging and dropping the HMI icon. Once it is selected, it cannot switch over to the other mode. So this parameter is only for reference here.

Description: Description of the HMI, which will be displayed in the HMI description frame during download or simulation to help user distinguish different HMI panels.

7.2 Taskbar

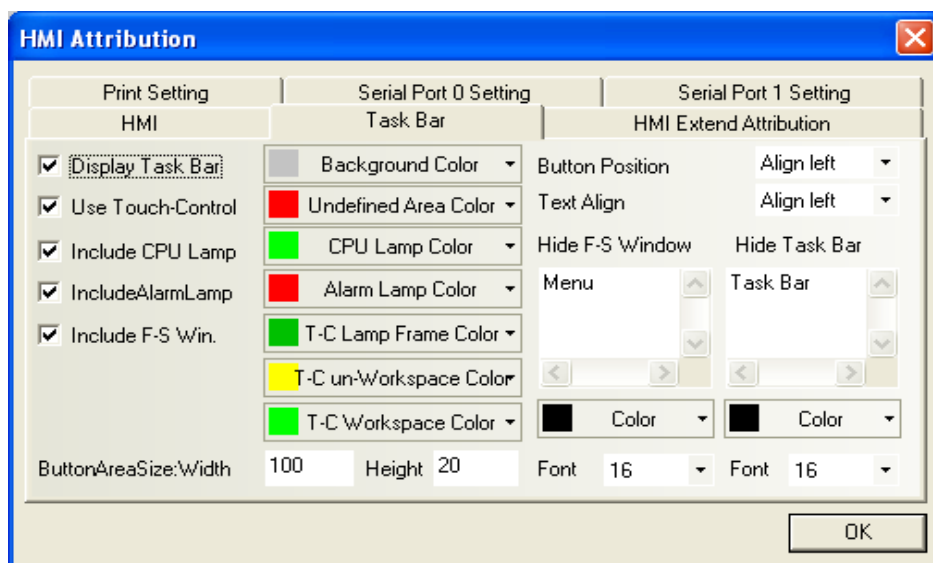

Display taskbar: Determine whether to display the taskbar. If this check box is selected, the taskbar shown in the above figure will be displayed in the lowermost part of the screen.

Use touch lamp: When the screen is touched, the lamp will blink. If this check box is selected, the touch screen lamp will be displayed in the right part of the taskbar, as shown in the above figure. The touch lamp can blink different colors when you touch the three types of panel area: workspace area, un-workspace area and undefined area. The color will indicate which kinds of area you are touching, help you touch the correct position.

Include CPU lamp: The CPU lamp is a bar graph showing the percentage of CPU resources currently being used. If this check box is selected, the CPU lamp will be displayed in the right part of the taskbar, as shown in the above figure.

Include alarm lamp: Alarm lamp is a bar graph showing the percentage of the number of current alarms to the total number of alarms entered in the alarm message. If this check box is

selected, the alarm lamp will be displayed in the right part of the taskbar, as shown in the above figure.



Include fast selection window: Determine whether to include the fast selection window. If this check box is selected, the user can use the parts in the fast selection window to switch over between different windows. If this check box is not selected, the fast selection window will not appear.

Quicken pop-up of taskbar: Whether to quicken the pop-up speed of the taskbar.

Quicken fast selection window: Whether to quicken the pop-up speed of the fast selection window.

Background color: Select the background color of the taskbar from any of the following colors, or select **Custom** to configure your own color.



Undefined area color: When you touch an undefined touch area (that is, the area outside the valid touch area of the touchable parts, but still within the outline of the parts), the touch lamp will blink a color different from the color when touching the valid area of the touchable parts. The color for the non-effective touch is set here.

CPU lamp color: Set the color of the CPU lamp.

Alarm lamp color: Set the color of the alarm lamp.

Touch lamp frame color: Set touch lamp frame color.

Touch un-workspace area color: Displays the touch lamp color when touching a non-working area.

Touch workspace color: Displays the touch lamp color when touching a working area.

Hide fast selection window and **Hide taskbar**: The texts entered in these two boxes are the texts to be displayed in the **Display/Hide Fast selection Window** and **Display/Hide Taskbar** window.

Button Position: The position for fast selection window buttons and taskbar buttons is set here, only two options are provided: **aligning to the right** or **aligning to the left**. If the **Align Right** option is selected, the fast selection window buttons and taskbar buttons will be displayed in the lower-right corner of the screen; otherwise, they will be displayed in the lower-left corner.

Text Alignment: The alignment mode of the texts in the fast selection window buttons and taskbar buttons. You can enter a name in the fast selection window and taskbar, like “Start, Taskbar”.

Button Area Size: Select the width and height of the button area.

Font Size: Select the font size of the labels of the fast selection window button and taskbar button.

7.3 HMI Extend Attributions

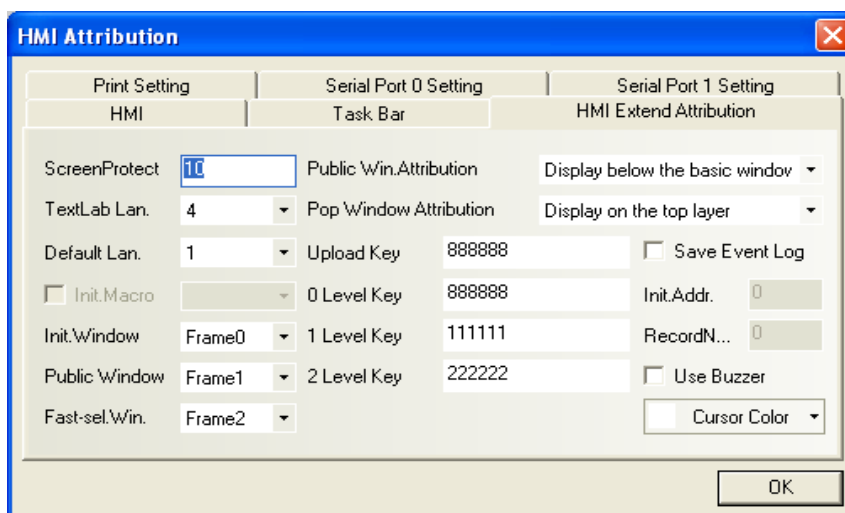

Screen Saver Time (Screen Protect): Indicates the time period after which the touch screen will enter the screen saver state if no touch operation is conducted during the period. (The time here is counted in minutes)

Text Library Languages: The number of languages included in the project, for example, English, Germany, French, and Chinese, or any other language. For details, refer to the description of text library in Chapter 6.

Default Language: The default language of the project when it is created.

Initial Macro: The number of the macro to be firstly run after the panel finishes power on and enter the application project.

Initial Window No: The number of the window to be displayed by the system firstly when the user power on the system and enters touch panel application program. The default initial window is window 0.



Note: The user can modify the **Initial Window No.** whenever it is necessary, open the project and change the initial window No. here and re-download the project to the panel, the change will take effect. Another method for changing the initial window number is introduced in chapter 16.

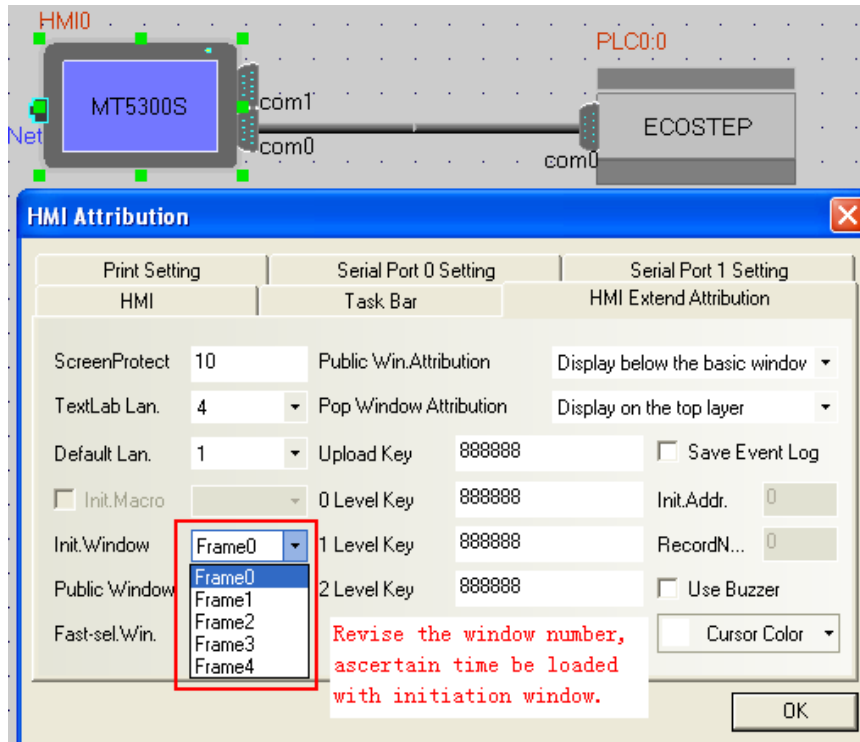

Common Window No. (Public Window): The window number of the common window in the project, window 1 by default.

Fast Selection Window No.: The window number of the fast selection window in the project, window 2 by default.

Common (Public) window Attribution: Defines whether the common window of the project is displayed above or under the basic window.

Pop-up Window Attribution: Set whether the pop-up window is displayed normally (the pop-up window doesn't make a monopoly of the topmost layer and other windows can be switched to the upmost layer) or is always displayed in the topmost layer.

Upload Password: Upload password for programs. The password helps prohibit unauthorized person uploading the project file from the panel to PC and hence protects the intellectual property of the project designer and authorized users. The initial password is 888888 by default.

Level 0-2 Password: Security password. For details, refer to Chapter 12, "Security Level".

Save Event Log: Check this checkbox if you want to save the event log.

Initial Address: Indicates the start address from which event log will be saved, the event log is saved in the RW (Recipe Word) registers.

Record Count: Indicates the maximum number of events to be saved.

Enable Buzzer: Enables/disables the buzzer. If this check box is selected, the system will give a buzz sound when the panel is touched.

About the storage of Event Library

Initial Address: The address of recipe card where the storage space for event library begins.

If the [Save Event Log] option is selected in the [HMI Attribution] dialog box is checked, the system will automatically save the triggered event information in the recipe card. The user doesn't need to care about the detail of saving event information. The saving procedure is automatically done by the system. The event library starts from the address specified in the [Initial Address] field. The default value is 0.

Data saved in the recipe card include Event Library Management Information and event entry information. The event library management information has 30 words and is saved from the [Initial Address]. The event entries are just saved after the management information. The length of an event entry is 20 words.

The following example will show the arrangement of memory space for event entry storage.

Open the [HMI Attribution] dialog box and select the check box [Save Event Log], as the following figure shows:

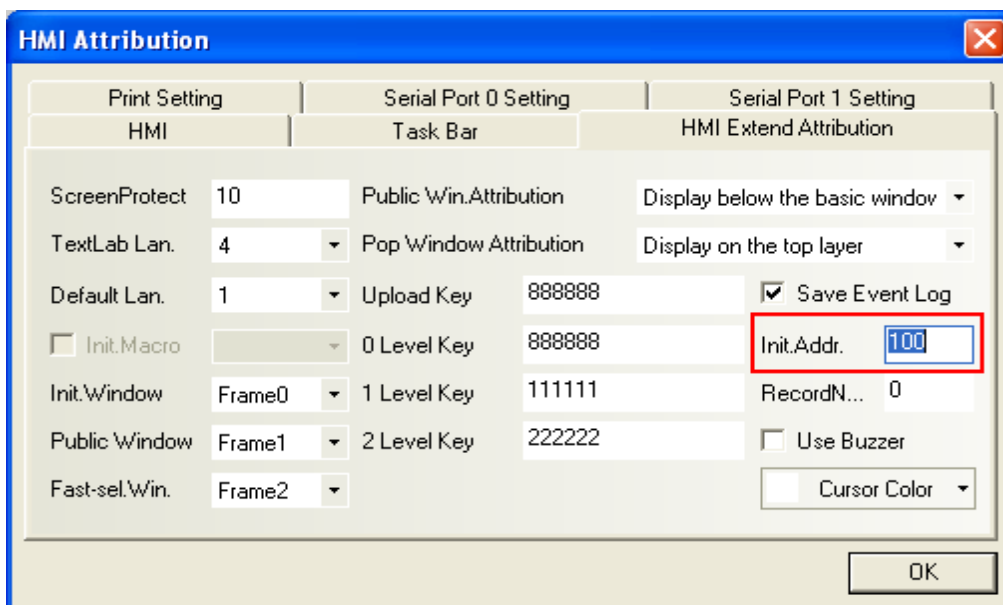

The system will reserve an area starting from RW100 for saving the event entry data. Suppose that we want to save an event entry management information and 200 event entries, as the following table shows:

Rcp. Card Addr.	Data
RW100	Event list management Info
RW130	Content of 1st event entry
RW150	Content of 2nd event entry
RW170	Content of 3rd event entry
? ? ? ? ?	? ? ? ? ?
? ? ? ? ?	? ? ? ? ?
RW4090	Content of 199th event entry
RW4110	Content of 200th event entry

The size of the reserved space is $200 \times 20 + 30 = 4030$ words. For users, this area cannot be written, any write operation will cause unpredictable results. The [Initial Address] can be designated by the user at his will. There are two notes on that address:

1. The desired memory area should not have any address conflict with the other registers in the project.
2. The end of the memory are should not exceed RW60000, spaces over RW60000 is reserved by the system.

7.4 Print Settings

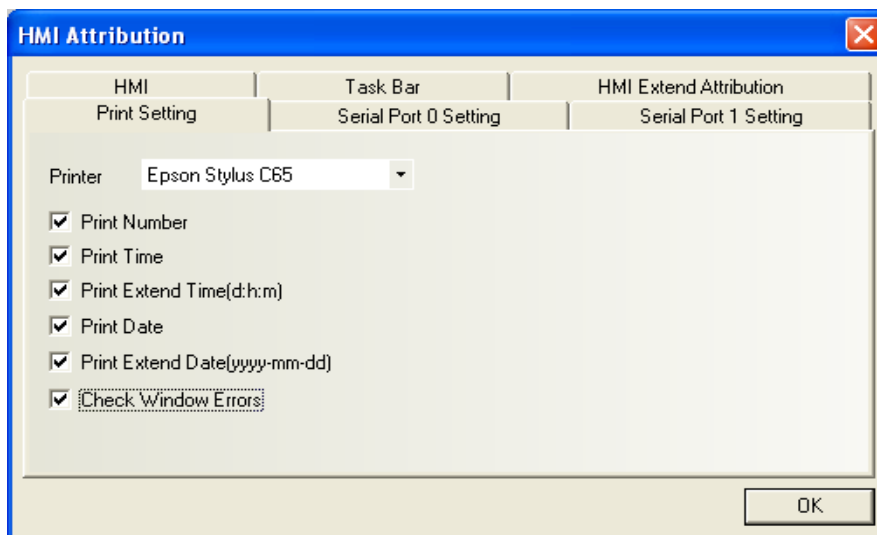

Printer: Select the printer model.

Print No.: If this check box is selected, a serial number will be printed out with the event message. The serial number will be increased with each new event.

Print Time: If this check box is selected, the print time will be printed out with the event

message.

Print Extend Time: Determine whether to print out the time in the format of “day: hour: minute”.

Print Date: Determine whether to print out the print date.

Print Extension Date: Determine whether to print out the date in the format of “YYYY-MM-DD”.

Check Window Errors: Determine whether to check errors in the window during printing.

For detailed print settings and methods, refer to Chapter 10.

7.5 COM Settings

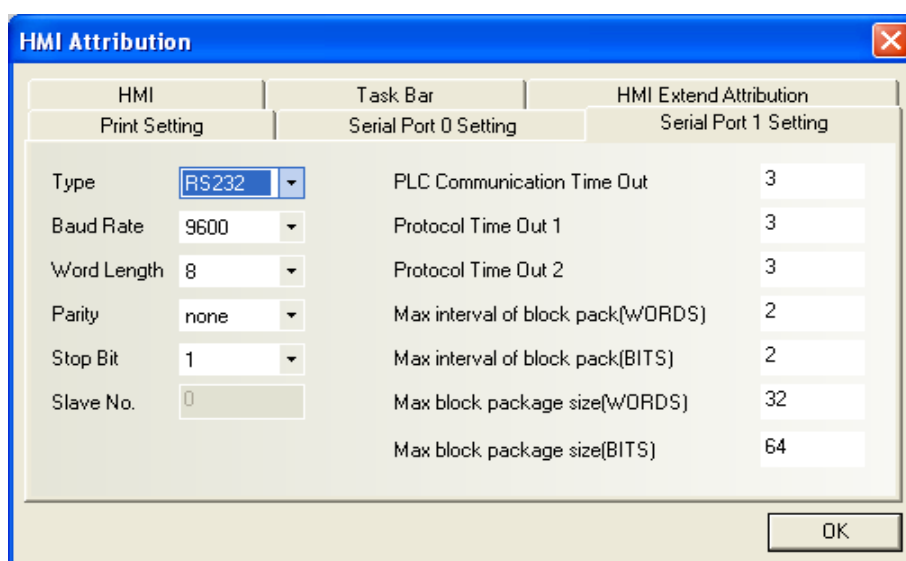

The MT5000/4000 series panels provide two serial ports, so the user has to configure COM0 and COM1 separately. The two serial ports can be used simultaneously, connecting with two PLCs. For communication with PLC, the two ports are identical. So we only introduce the setting of Port 1. Setting of Port 0 is the same.

Type: Select the communication mode of the touch panel and the PLC, including such options as RS232, RS485-2W and RS485-4W.

Baud Rate, Word Length, Parity and Stop Bits: Set the basic communication parameters matching the PLC.

Slave Station No.: In most cases, the touch panel is the master station and the PLC serves as the slave station, and this parameter is invalid then. When the touch panel serves as the slave station while the PLC serves as the master station, for example, selecting the MODBUS SLAVE protocol, set the slave station number for the panel here.

PLC Communication Timeout Time: This parameter determines the time used by the touch screen for waiting for the response of the PLC. When the delay for the communication between the PLC and the touch panel is longer than the timeout time, the touch panel will

display the message of “PLC NO RESPONSE”. In general, this parameter is set automatically when the user selects a PLC model, so it is not necessary for the user to set it in most cases.

Protocol Timeout Time 1/2: Communication protocol timeout time; in general, this parameter is set automatically when the user selects a PLC, so it is not necessary for the user to set it.

Max interval of block pack (WORDS), Max interval of block pack (BITS), Max block package size (WORDS), Max block package size (BITS): The touch panel HMI will automatically collect the PLC data with consecutive addresses and will send a single read command to read such multi-addressed data, which greatly enhances communication efficiency and shortens response time. The parameters **Max block package size (WORDS)** and **Max block package size (BITS)** determine the maximum number of word and bit registers that can be read consecutively. The values are usually automatically set when the user selects a PLC, so it is not necessary for the user to set them.

If the addresses of such PLC data are not consecutive, the touch panel will read such data by separate commands, so a lot of read commands are required for reading such data. Therefore, we allow a user to modify the interval by modifying the parameters of **Max interval of block pack (WORDS)** and **Max interval of block pack (BITS)**. When the interval between two addresses is longer than the set value, they will be read as two packages; otherwise, they will be read as a package. In this way, it reduces communication packages and enhances communication speed.

An example:

As shown in the figure below, to read data from D20 to D29, when the PLC package is set to 0, the system has to use 3 read commands to read such data. When the **Max interval of block pack (WORDS)** is set to 1, the system can read such data with only one command. In general, the time used for reading additional two addresses (D23, D25) is far less than the time used for reading two packages, thus, communication time is saved.

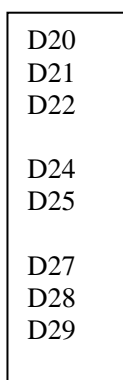

Note: Set the ports according to the physical connection. For example, if the PLC is going to be connected to COM1 in real application field, set the parameters of COM1 in the **HMI Attribution dialog box**.

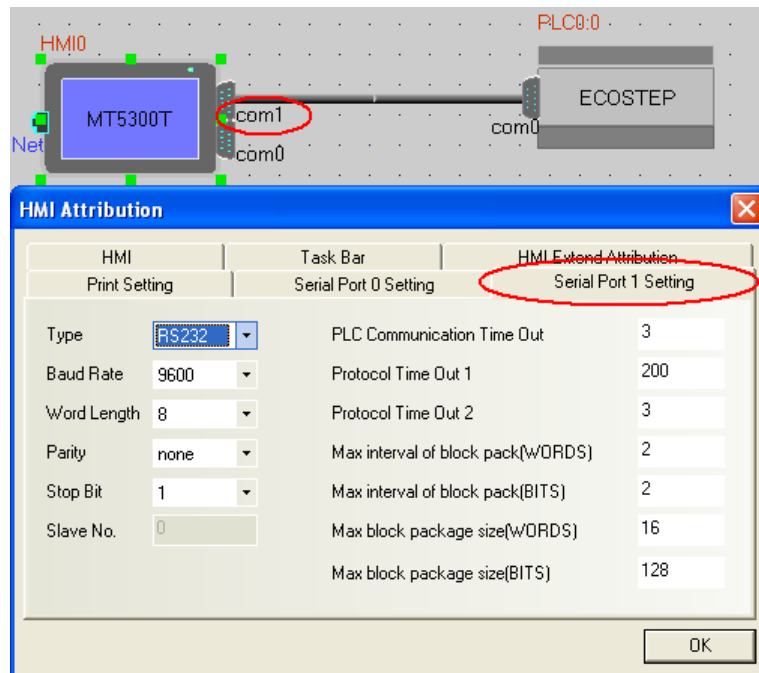

Note: In general, do not modify the parameters in the right column as shown below except that you are an advanced user and it is necessary to adjust them.

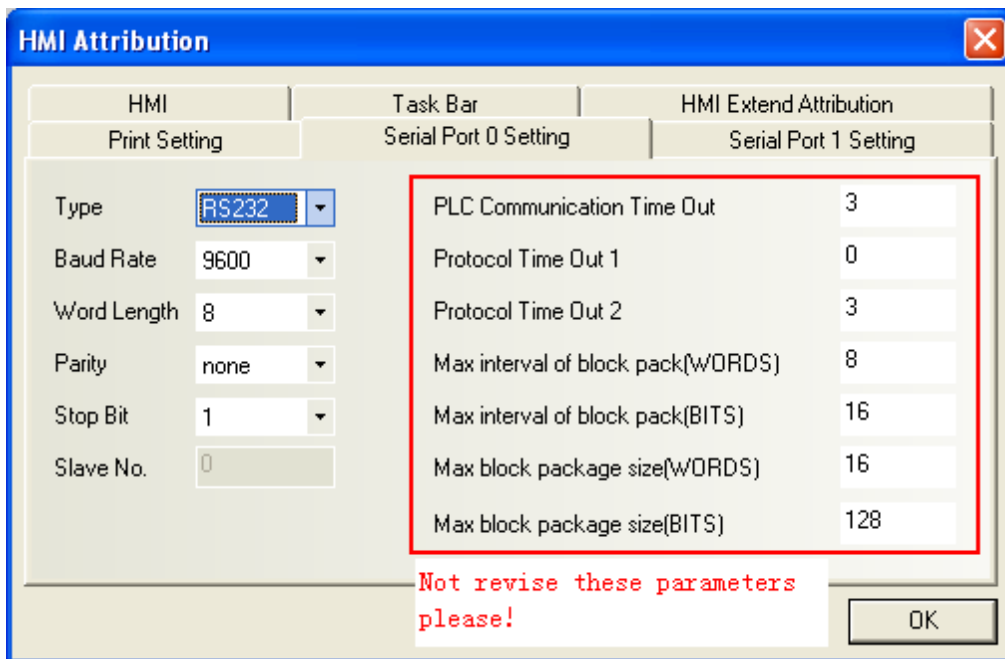

7.6 PLC Station No.

Double click the PLC icon in the project window, the following window appears. Where, the user can set PLC station No. The value here must be the same as the actual PLC station number set with the PLC programming software, otherwise, it may cause a communication failure.



Note: If the selected PLC protocol is a slave protocol (that is, the HMI serves as a slave station), the station No. cannot be set.

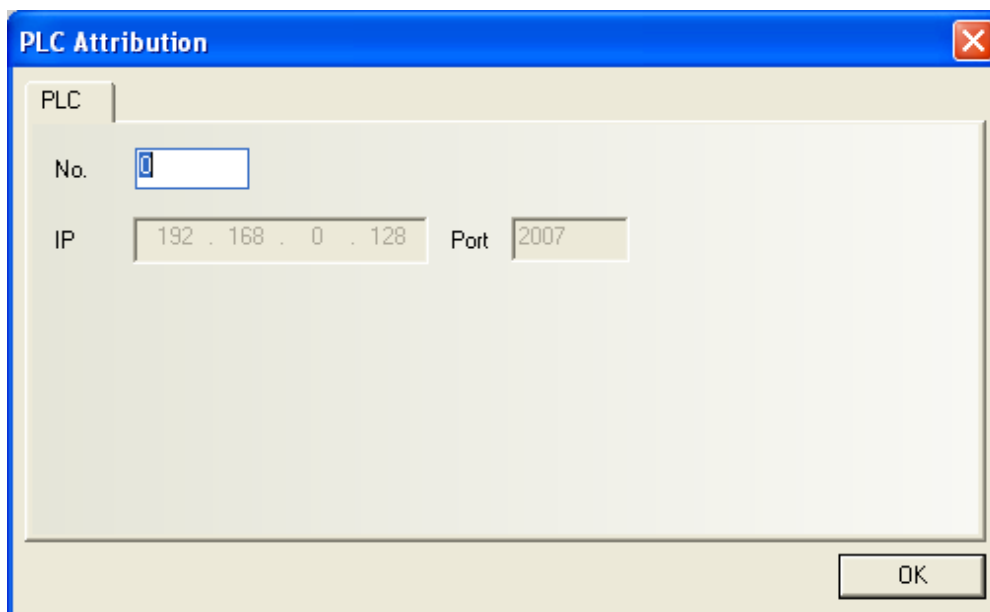

Chapter 8 Recipe Data

The recipe data transmission component can activate the data transmission of a consecutive register. It supports downloading data from the memory of the recipe card to the PLC, as well as uploading data from the PLC to the memory of the recipe card. The size of the transmission data can be set. For MT5000 HMI, a 256K-Byte memory card can be selected to store recipe data. For MT4000 HMI, the capacity of the recipe memory is 128K-byte.

8.1 Creating a Recipe Data Transmission Component



1. Press the recipe data transmission component icon , and the following window appears. Enter related contents in the **[Basic Attribution]** tab.

[Output Address]: Refers to the initial address of a consecutive PLC register, the word addresses designated by the **[Data Length]** after this address can be used to transmit data.

[Address]: Address corresponding to the recipe data transmission component.

[Code Type]: BCD or Binary.

[Word No.]: Depends on the number of data to be transferred later.

[Use Address Tag]: Whether to use the established address tag; for details refer to Section 6.35.

[Description]: Reference name assigned to the recipe data transmission component (do not display).

2. Click the **[Recipe Data]** tab and set the function and data length.

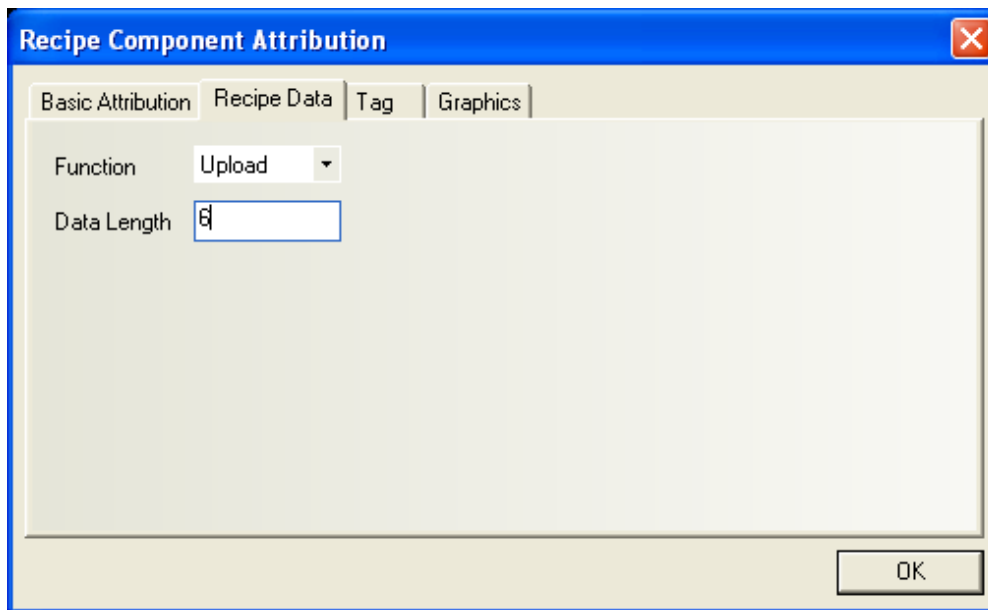

[Function]:

Download: Transferring data from the recipe memory of the touch screen to the PLC.

Upload: Transferring data from the PLC to the recipe memory of the touch screen.

[Data Length]: The data to be transferred in the unit of words.

3. In the **[Graphics]** tab: Select vectograph or bitmap to display the component.
4. In the **[Tag]** tab: Enter the words to be displayed.
5. Click **[OK]**, place the component and adjust its size.

8.2 Recipe Memory

The recipe memory is the SRAM with backup batteries. Therefore, the contents in the memory can be saved for at least half a year after power failure. When the system is powered on, the batteries will be automatically charged. The total size of the recipe memory is 64k words. The recipe memory has two expressions: “RW” indicates the absolute address, while “RWI” indicates the index address. “LW9000” indicates the offset of the index address. For example, if the LW9000 is 50, the index address RWI 0 will direct at the data of the address RW50. At this time, if we change the data of LW9000 to 51, the index address RWI 0 will direct at the data of the address RW51, as shown in the figure below:

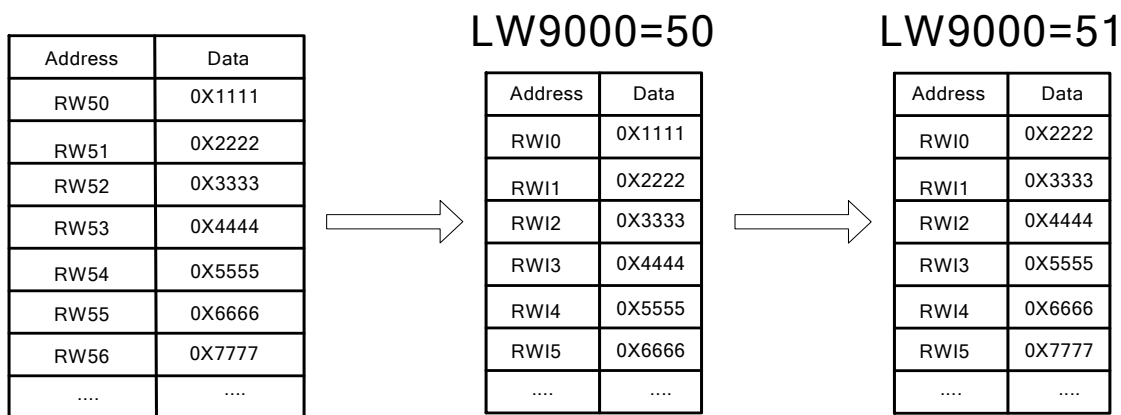

Based on the above basic concepts, the following is an example: We designate a project and select the "MODBUS RTU" as the PLC type. The following section describes how to upload 5-word text data beginning from the slave address 200 and with the slave address type of 4x to the RW300 address of the recipe memory. The implementation process is shown as follows:

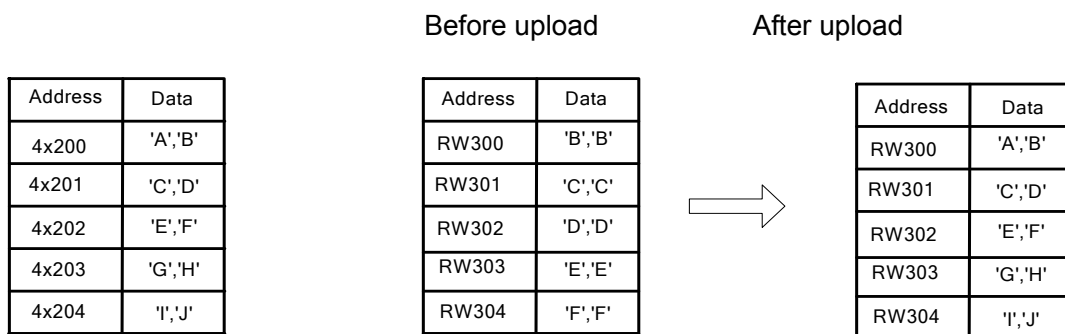

Create a new project and select [MODBUS RTU] for the PLC type

Firstly, create a component for uploading recipe data: Set [Address Type] to 4x, [Address] to 200, [Function] to Upload, and [Data Length] to 5. Select the [Use Address Tag] check box. The label content is [Upload], as shown in the figures below:

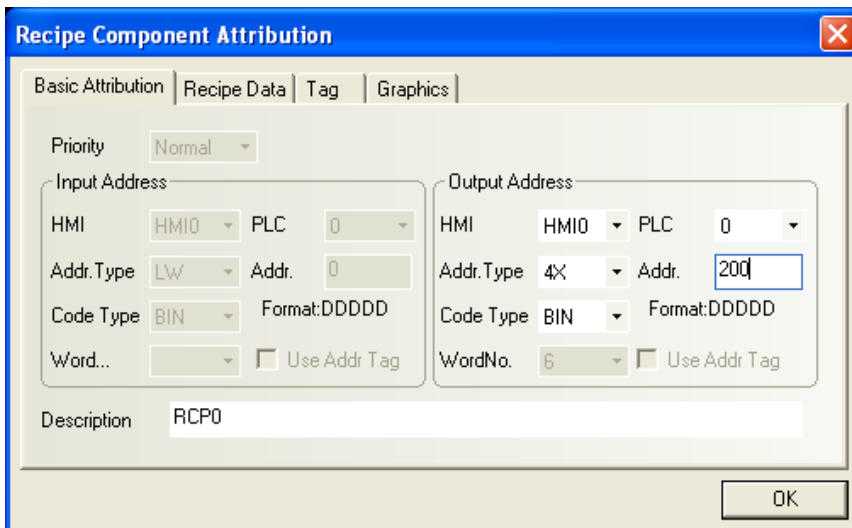

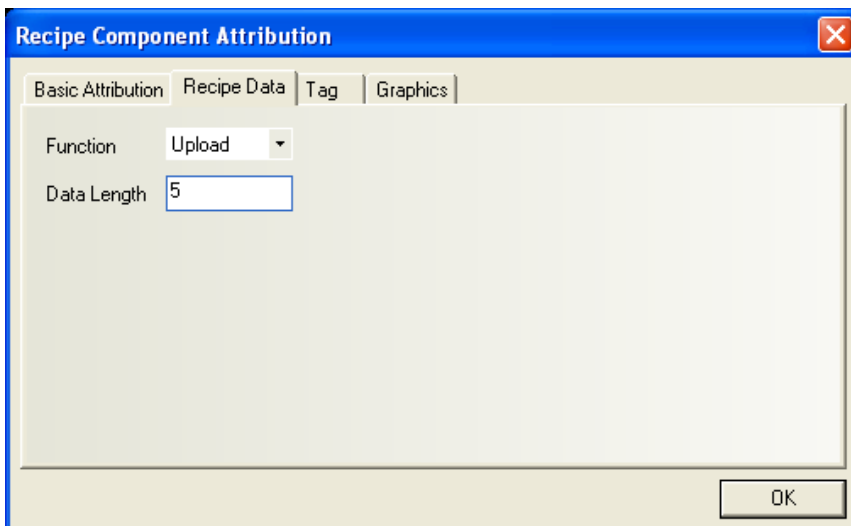

Place it on the window:

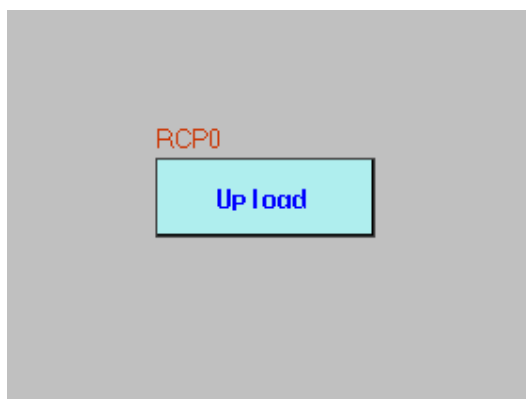

The recipe data transmission component is made, but it only indicates that the five words with the starting address of 4x200 shall be transferred to the recipe memory, and it does not suggest the specific position in the recipe memory. This is where the reserved keyword LW9000 of the system works. Set the value of LW9000 to 300 and press transmission component key. The five words with the starting address of 4x200 will be transferred to the position of five words with the starting address of RW300 in the recipe memory. To transfer the five words with the starting address of 4x200 to the position RWI00 in the recipe memory, set the value of LW9000 to 100 and press the transmission component key.

To complete the transmission, we have to make a text input component to modify the upload data. Set [**Address Type**] to 4x, [**Address**] to 200, and [**Word No.**] to 5. Set trigger address type to LB and address to 9000. It is shown in the following figure.

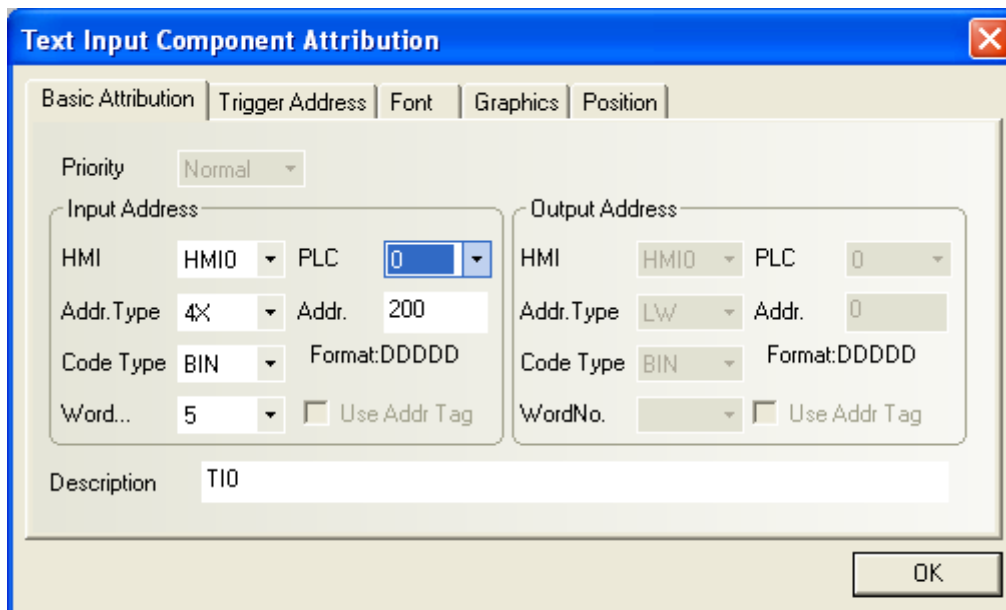

Make a numeric input component to modify the LW9000 data. Set **[Address Type]** to **LW**, and **[Address]** to **9000**. Set trigger address type to LB and address to 9000. It is shown in the following figure.

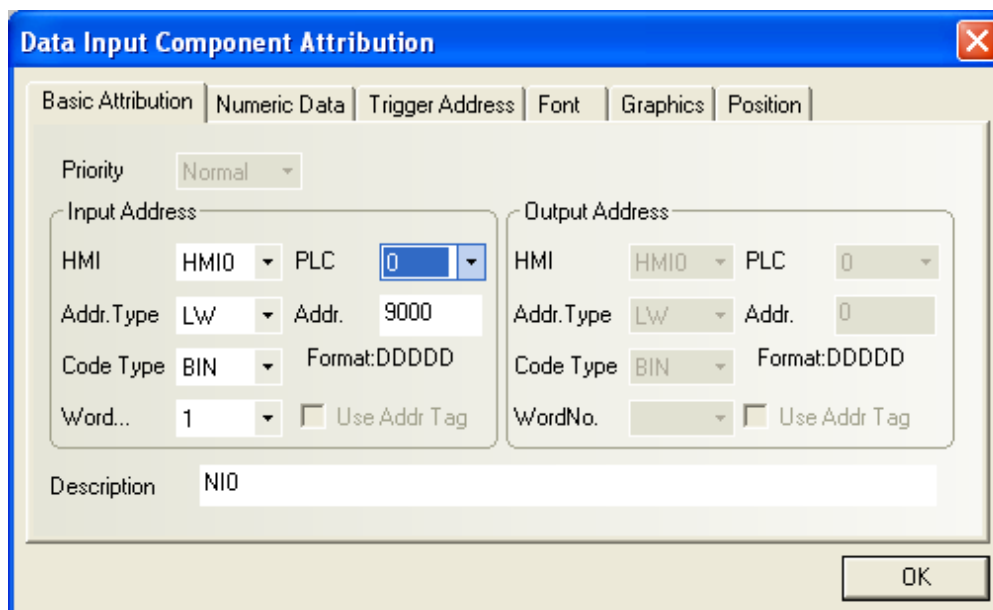

To verify whether the data is transferred, place a text input component to display the RW300 data. Set **[Address Type]** to **RWI**, **[Address]** to **0**, and **[Word No.]** to **5**. Set trigger address type to LB and address to 9000. It is shown in the following figure.

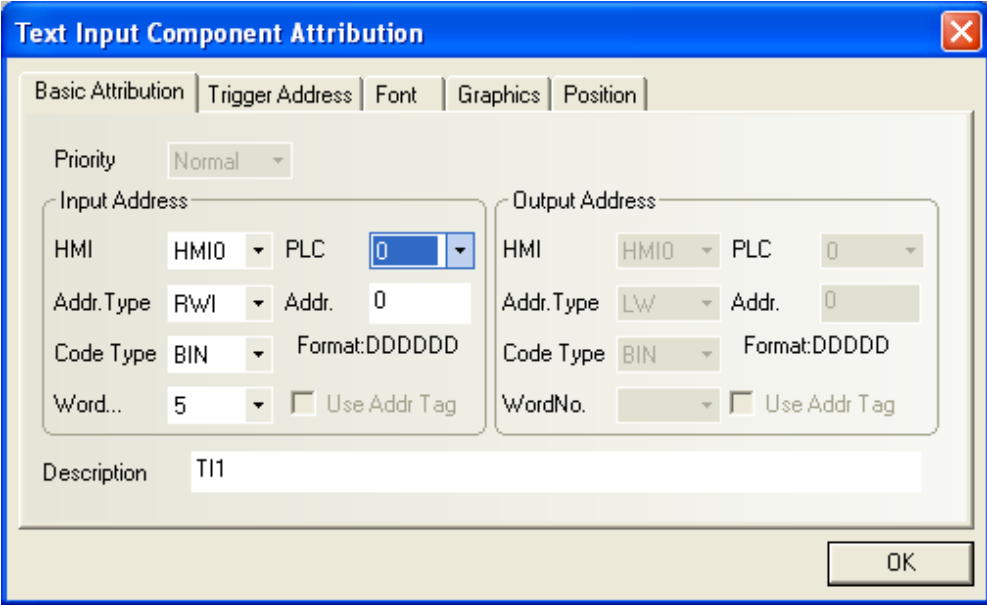

Place a keypad. The completed project is shown in the figure below:

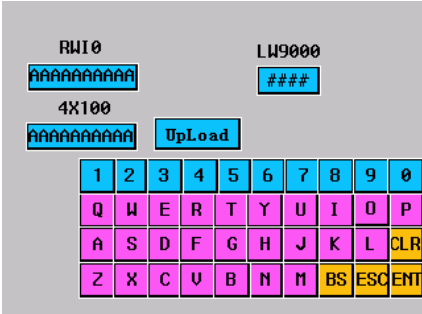

Save and compile the project, run the project in the offline simulation mode. Firstly, change LW9000 to 300. Since LW9000 indicates the offset of the index address, RWI0 displays the data of RW300 address, as shown below:



Then, enter the text data “**QWERTYUIOP**” in the [4x100] text box and click the [**Upload**] key. The RWI0 displays the same data as the [4x100] text box. It indicates the uploading succeeds, as shown in the figure below:



How to download the five words with the starting address of RW300 to the position with the starting address of 4x200? The following is an example showing the implementation process. Add a recipe data transmission component to the above project. Set [**Address Type**] () to 4x, [**Address**] to 200, [**Function**] to **Download**, [**Data Length**] to 5, and the label content is [**Upload**], as shown in the figures below:

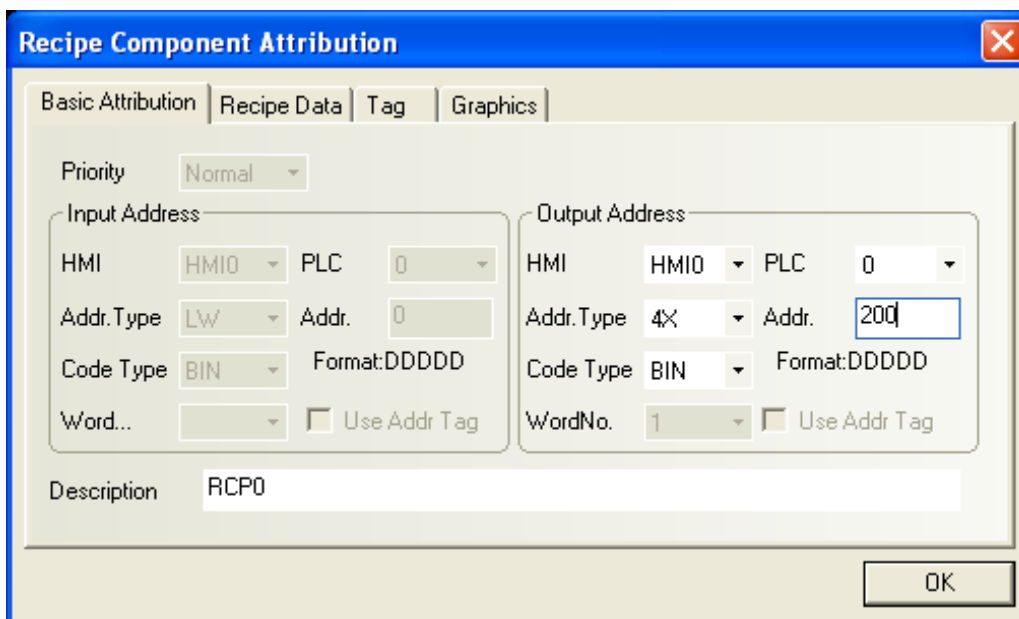

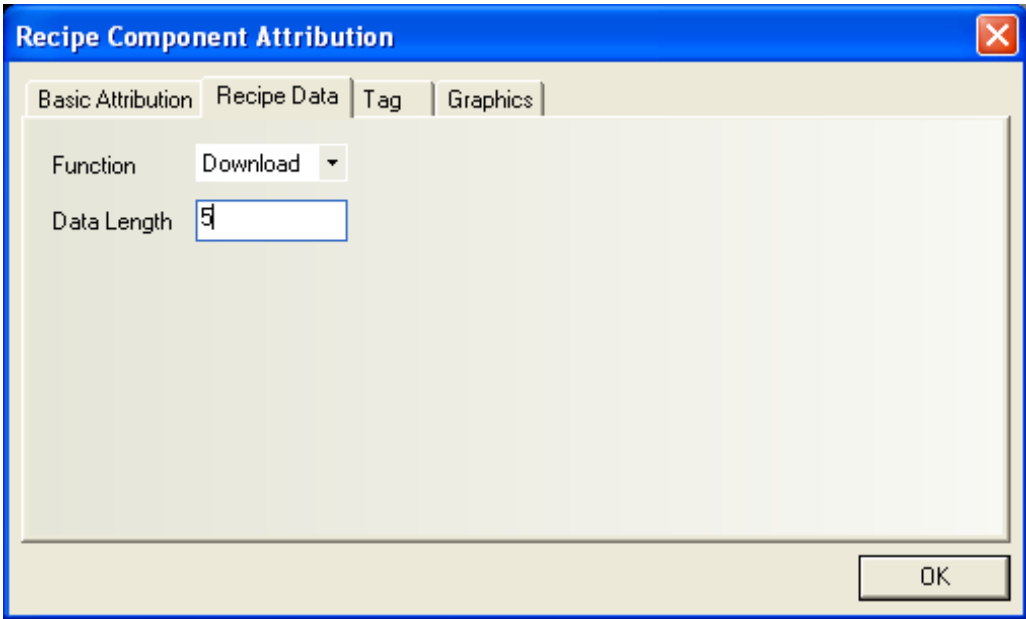

The completed project is shown as follows:

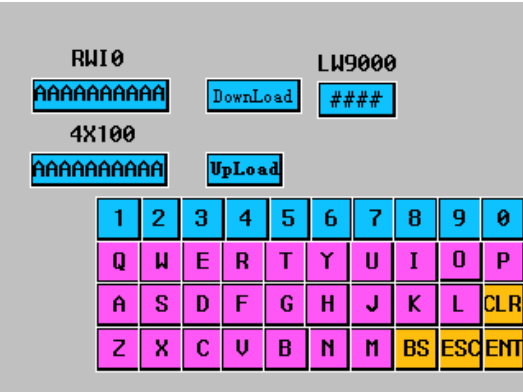

Run the project in offline simulation mode. Firstly, set the value of LW9000 to 300 and enter "AAAAAAAAAA" in the RWI0 text box. The operating state is shown as follows:



Click [**Download**]. The text data will be transferred from RW300 to 4x100.



In the above example, we find that whether uploading PLC data to the recipe memory or downloading data from recipe memory to the PLC, the starting position of the recipe memory data is the value corresponding to the LW9000 address. This is important for implementing some complicated recipe data functions. The section below gives a detailed description of the usage of the recipe memory data.

8.3 Uploading/Downloading of Recipe Data Between Touch Screen and PLC

Recipe data is very important. For example, in an industrial production line, the production equipment can fulfill different tasks according to different parameters. We can store a group of

data to the recipe memory in a defined format and revoke such data when necessary. In this way, we do not need to enter data temporarily, which greatly enhances production efficiency.

◆ **The following example shows how to conveniently invoke multiple recipe data**

Suppose we have ten groups of recipe data in total, each group consists of five words, among which recipe name occupies four words and recipe data occupies one word. We plan our recipes from RW0 as follows:

Rcp. Grps.	Reg. Addr.	Name of Rcp. (4 words)	Rcp. Data (1 word)
Group 0	RW0-RW4	"AAAAAAA"	0
Group 1	RW5-RW9	"BBBBBBB"	1111
Group 2	RW10-rw14	"CCCCCCC"	2222
Group 3	RW15-RW19	"DDDDDDD"	3333
Group 4	RW20-RW24	"EEEEEEE"	4444
Group 5	RW25-RW29	"FFFFFFF"	5555
Group 6	RW30-RW34	"GGGGGGG"	6666
Group 7	RW35-RW39	"HHHHHHH"	7777
Group 8	RW40-RW44	"IIIIIII"	8888
Group 9	RW45-RW49	"JJJJJJJ"	9999

It is expected that each group of recipe in the above figure can conveniently conduct data exchange with PLC equipment register 4x100 through project design. Firstly, let's take a look at a completed project shown in the figure below to gain an overall concept. In the project, RWI0 and RWI4 show the recipe data of group 0. Click **[Download]** to download the recipe data to 4x100. Click **[Upload]** to upload the 4x100 data to the recipe memory. Click the **[Up]** direction key on the right to query previous recipe data so that the user can modify and transfer recipe data; Click the **[Down]** direction key on the right to query next recipe data.

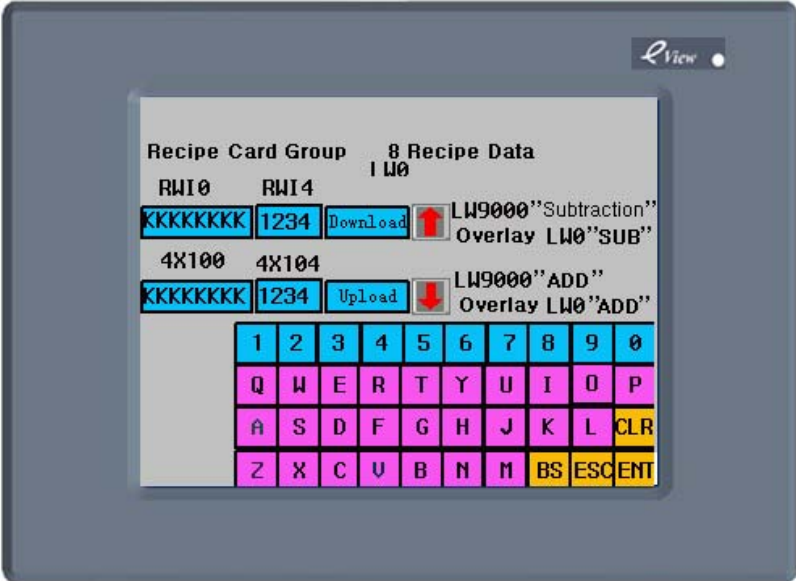

This gives us a rough idea on the design purpose of the project. The following section will detail the preparation process of the project.

Firstly, create a new project and select [MODBUS RTU] for the [PLC Type]

Create a text input component to display and modify the each group of recipe name. Set the [Word No.] to 4.

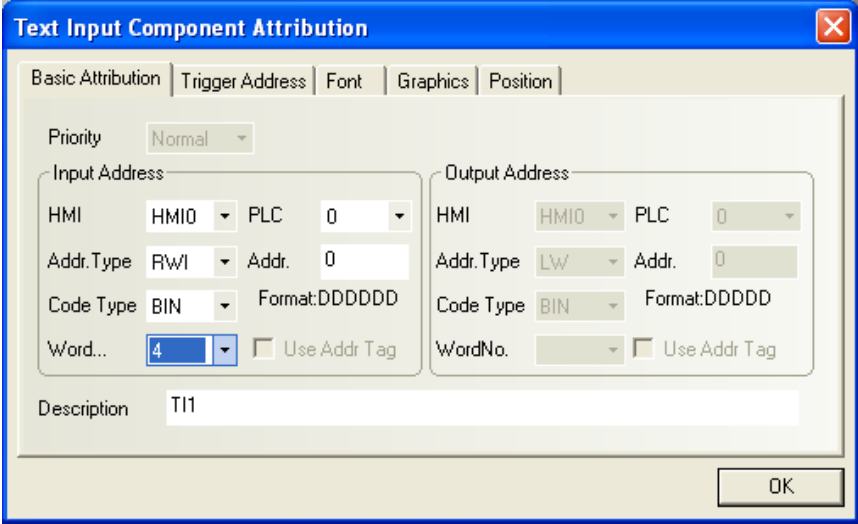

Create a numeric input component to display and modify each group of recipe data.

Data Input Component Attribution

Basic Attribution | Numeric Data | Trigger Address | Font | Graphics | Position

Priority: Normal

Input Address:

HMI: HMIO | PLC: 0

Addr. Type: RWI | Addr.: 4

Code Type: BIN | Format: DDDDDD

Word...: 1 | Use Addr Tag

Output Address:

HMI: HMIO | PLC: 0

Addr. Type: LW | Addr.: 0

Code Type: BIN | Format: DDDDD

WordNo.: | Use Addr Tag

Description: NI1

OK

Create a text input component and a numeric input component to display and modify the recipe data on the PLC.

Text Input Component Attribution

Basic Attribution | Trigger Address | Font | Graphics | Position

Priority: Normal

Input Address:

HMI: HMIO | PLC: 0

Addr. Type: 4X | Addr.: 100

Code Type: BIN | Format: DDDDD

Word...: 4 | Use Addr Tag

Output Address:

HMI: HMIO | PLC: 0

Addr. Type: LW | Addr.: 0

Code Type: BIN | Format: DDDDD

WordNo.: | Use Addr Tag

Description: The name of PLC Recipe Data

OK

Data Input Component Attribution

Basic Attribution | Numeric Data | Trigger Address | Font | Graphics | Position

Priority: Normal

Input Address:

HMI: HMIO | PLC: 0

Addr. Type: 4X | Addr.: 104

Code Type: BIN | Format: DDDDD

Word...: 1 | Use Addr Tag

Output Address:

HMI: HMIO | PLC: 0

Addr. Type: LW | Addr.: 0

Code Type: BIN | Format: DDDDD

WordNo.: | Use Addr Tag

Description: NI2

OK

Create two recipe data transmission components: one is for downloading recipe data, and the other is for uploading recipe data. The address for both of them is 4x100.

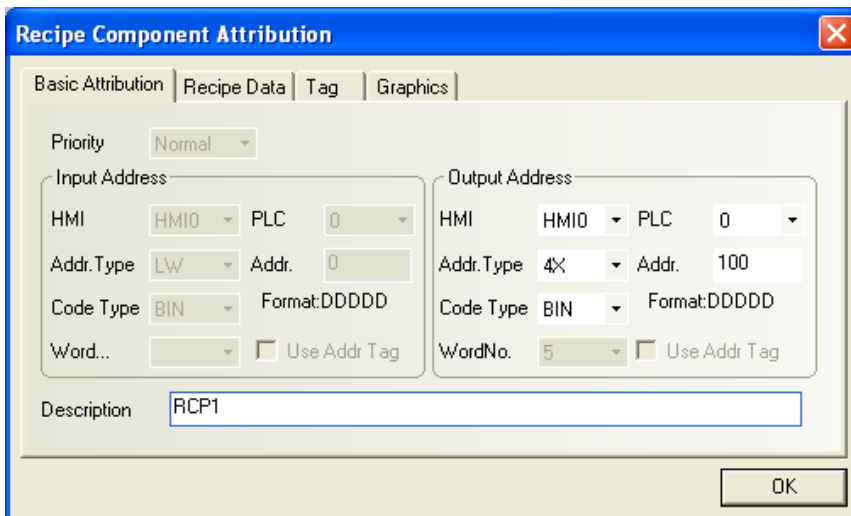

In addition, we have to design two buttons to enable a user to query and modify each group of recipe data conveniently. One button is to query previous data, and the other is to query next data. The former is a multi-state setting component. Each time when you press this button, the system will deduct 5 from the value of LW9000 because each group of recipe data consists of five words. Press this button once, and the RWI0 can display the data of the previous recipe, as shown in the figure below:

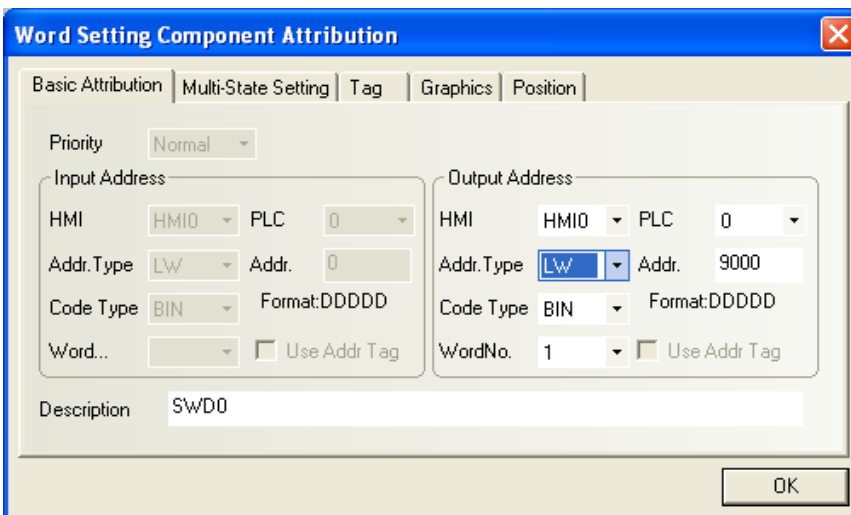

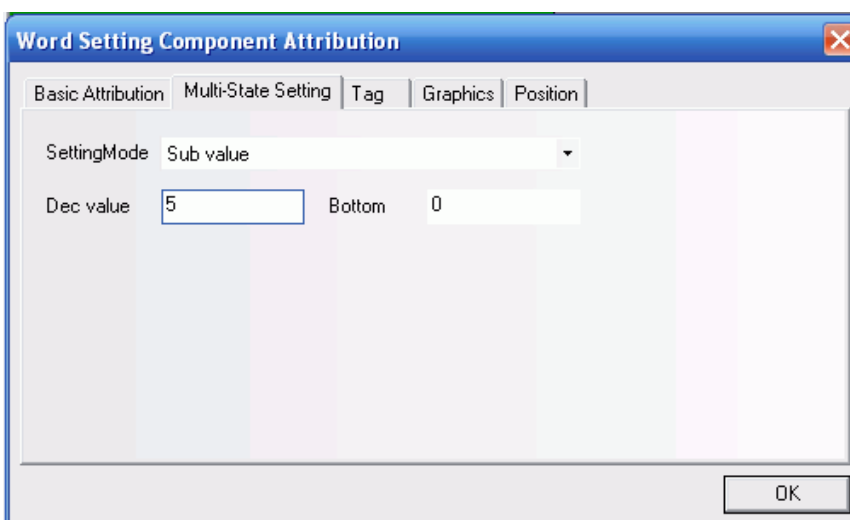
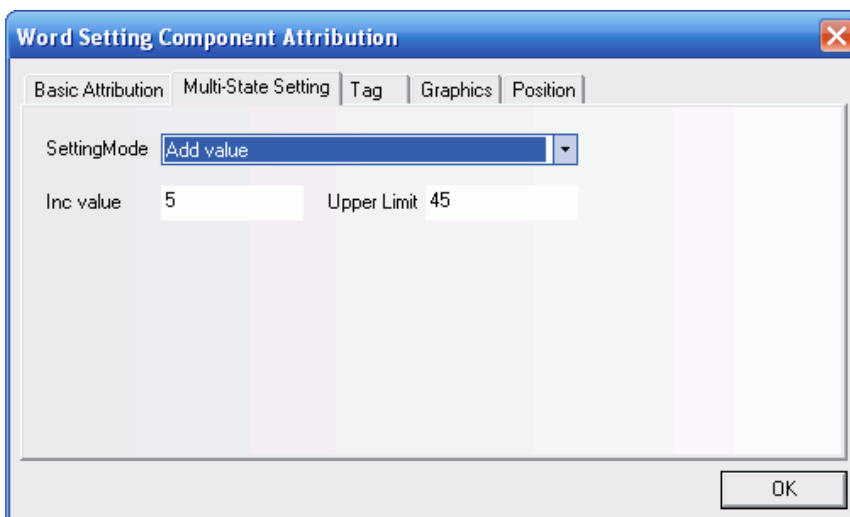

The button for querying the next recipe is also a multi-state setting component. Each time when you press this button, the system will add 5 to the value of LW9000 because each group of recipe data consists of five words. Press this button once, and the RWI0 can display the data of the next recipe. The upper limit for this parameter is 45 (10 groups of recipes).

How to know which group the current recipe is? What controls the value displayed by LW0? We can make two more multi-state setting components, with the address of LW0 both. One is for deduction and the other is for addition, without the need of any shapes, as shown in the figures below:

Word Setting Component Attribution

Basic Attribution | Multi-State Setting | Tag | Graphics | Position

Priority: Normal

Input Address:

HMI: HM10 | PLC: 0 | Addr. Type: LW | Addr.: 0 | Code Type: BIN | Format: DDDDD | WordNo.: 1 | Use Addr Tag

Output Address:

HMI: HM10 | PLC: 0 | Addr. Type: LW | Addr.: 0 | Code Type: BIN | Format: DDDDD | WordNo.: 1 | Use Addr Tag

Description: SWD2

OK

Word Setting Component Attribution

Basic Attribution | Multi-State Setting | Tag | Graphics | Position

SettingMode: Add value

Inc value: 1 | Upper Limit: 9

OK

Word Setting Component Attribution

Basic Attribution | Multi-State Setting | Tag | Graphics | Position

SettingMode: Sub value

Dec value: 1 | Bottom: 0

OK

Overlap the component whose **[Setting Mode]** is **[Sub Value]** on the multi-state component created earlier whose type is also deduction and whose address is LW9000. Overlap the

component whose [Setting Mode] is [Add Value] on the multi-state component created earlier whose type is also addition and whose address is LW9000. In this way, when we browse recipe data, the value of LW0 changes to indicate the group number of the current data.

Place a keypad on the window and make some text decoration, and the project is completed.

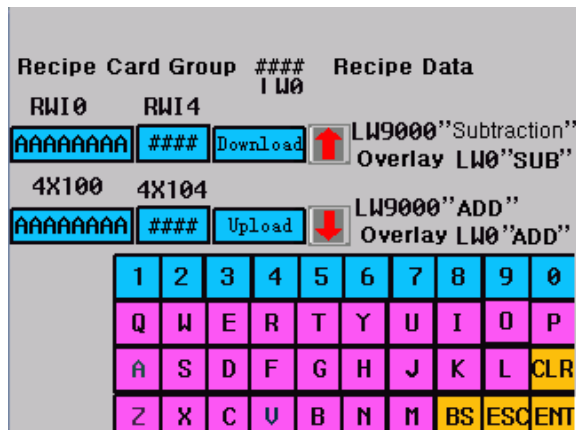

Save it to disk, compile it, and run the project in the offline simulation mode:

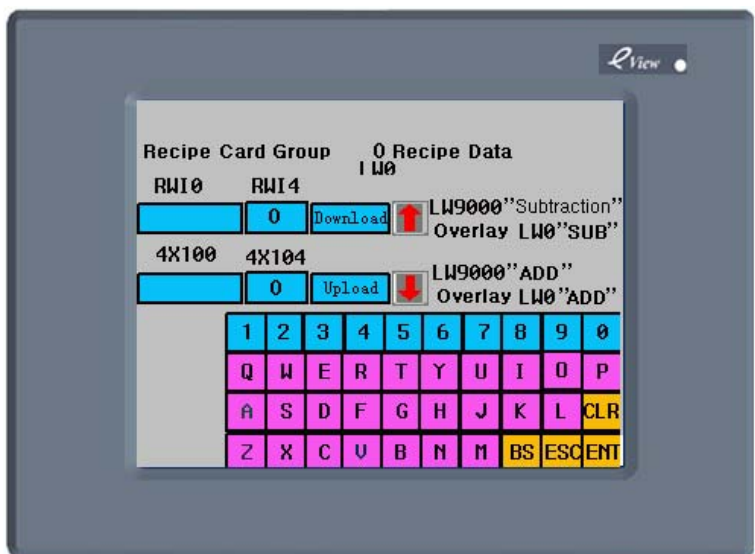

Enter the above-mentioned ten groups of recipes into the recipe memory. Then, we turn to the group 8, change the recipe name to "KKKKKKKK", change the data to 1234, and click [Download], as shown in the figure below:

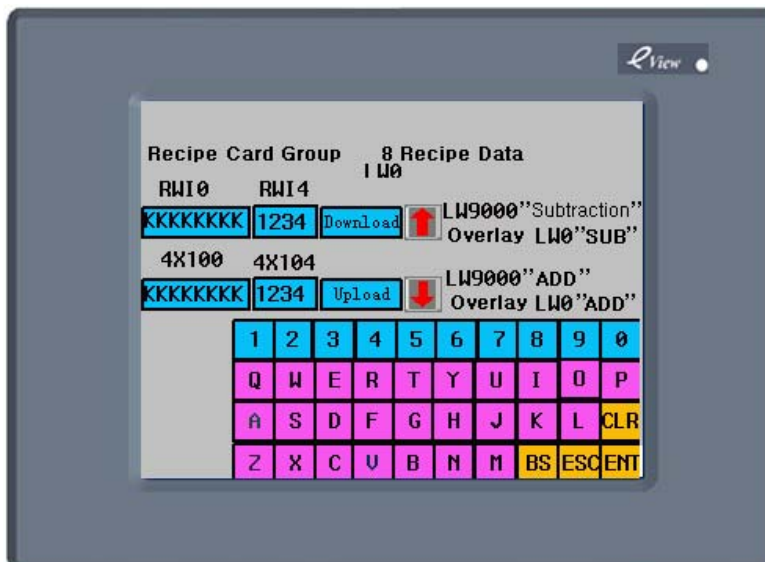

We can see that the data of 4x100 changes to “KKKKKKKK”, 1234. The change in the memory is shown as follows:

Rcp Grp	Reg. Addr.	Name of Rcp. (4 words)	Rcp. Data (1 word)
Group 0	RW0-RW4	“AAAAAAAA”	0
Group 1	RW5-RW9	“BBBBBBBB”	1111
Group 2	RW10-rw14	“CCCCCCCC”	2222
Group 3	RW15-RW19	“DDDDDDDD”	3333
Group 4	RW20-RW24	“EEEEEEEE”	4444
Group 5	RW25-RW29	“FFFFFFFF”	5555
Group 6	RW30-RW34	“GGGGGGGG”	6666
Group 7	RW35-RW39	“HHHHHHHH”	7777
Group 8	RW40-RW44	“KKKKKKKK”	1234
Group 9	RW45-RW49	“JJJJJJJJ”	9999

Addr.	Data
4x100-4x103	“KKKKKKKK”
4x104	1234

After learning the preparation process of this project, we should learn the basic project design of recipe data. The user can make full use of the diversified features of the EV5000 configuration software to produce better projects.

Chapter 9 Macro Code

Macro instructions are a kind of advanced touch screen control method which strengthens the functions of the touch screen. The touch screen will have the same logic and arithmetic operations as the PLC by the programming of macros. Flexibly use of macros will enable the touch screen to implement many powerful functions that cannot be supported by many regular components and to make your human-machine interfaces more perfect.

The EV5000 provides totally new macros different from the macro script language modes of other human machine interfaces. The macro is fully compatible with standard C language (ANSI C89). Since abundant documents and data on the C language are easily available, this chapter will not describe syntax and basic knowledge of the C language. Instead, it focuses on the creation and usage of macros through examples.

9.1 Getting started: A Simple Macro Template

The following section describes how to compile a simple macro template, and the macro template will implement the following simple operation functions:

Read two signed numbers, divide LW0 with LW1, and place the result of a double float in the four words of LW2~LW5.

Click the macro icon  in the toolbar of the database or select the **[Add Macrocode]** command in the **[File]** menu.

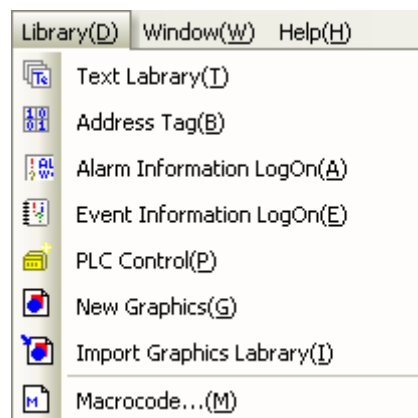

The following dialog box appears.

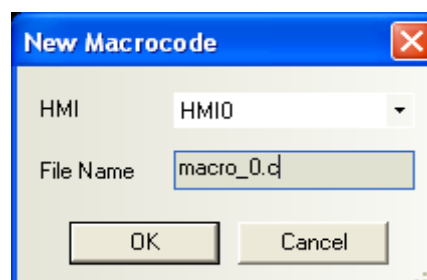

Select an HMI number and enter a file name in the **[File Name]** text box. Click **[Create]** to enter the macro editing window, as shown below:

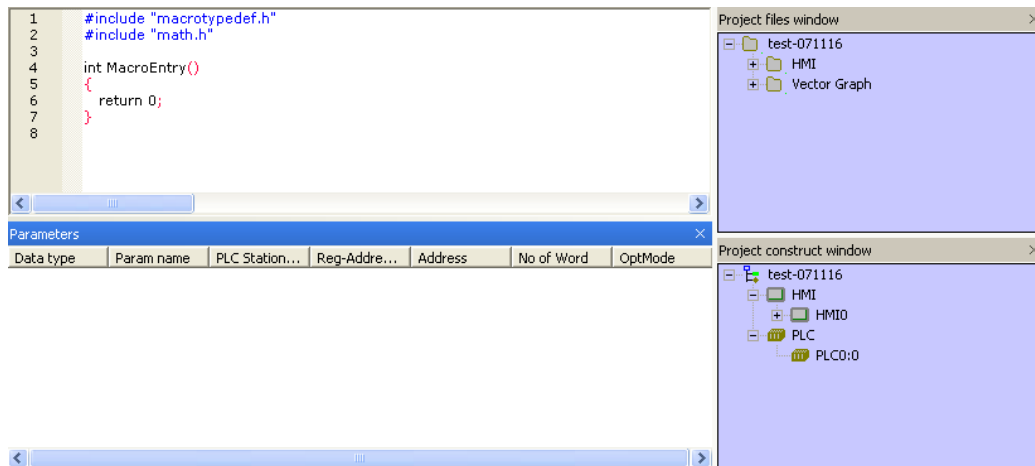

Before compiling macrocodes, define input and output variables.

Right click in the **[Macrocode Variable Window]**, and the following menu appears:

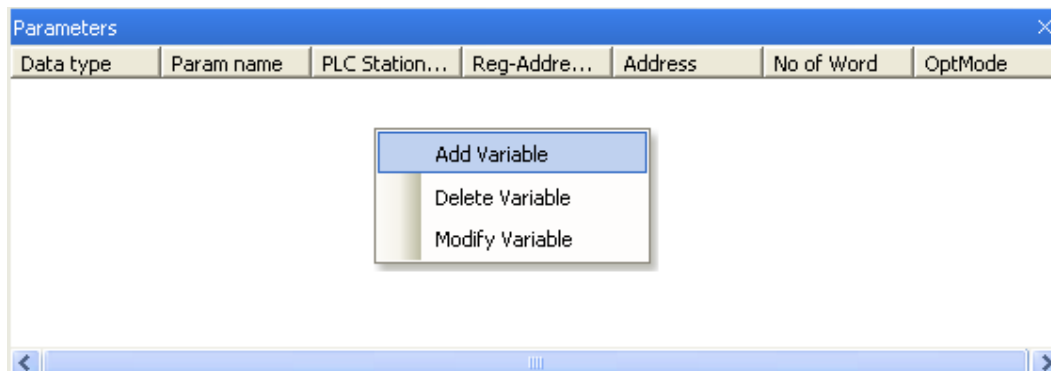

Select **[Add Variable]**, and the following dialog box appears:

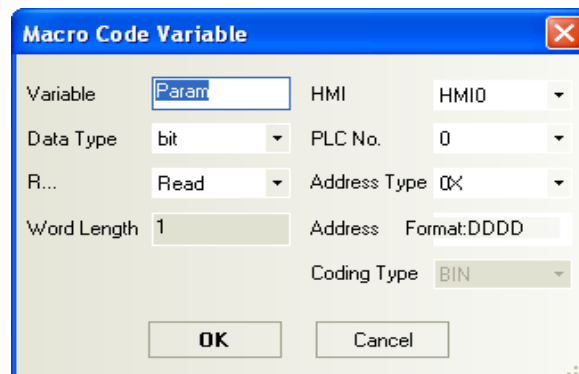

Firstly, assign a name to the variable:

Variables are divided into two types: Reading variables and Writing variables. They are distinguished from each other by read/write attributes. Reading variable means the macro code will obtain the value of the variable from a designated address, while writing variable means writing an operating result from the execution of macrocode into a designated address. Therefore, read/write variables are different variables for the same address. Therefore, it is recommended that `_R` and `_W` be used to distinguish them when naming a variable.

In this example, LW0 and LW1 are reading variables and LW2 is a writing variable. Therefore, we name them as follows: LW0_R, LW1_R, LW2_W. Please note that the variable name shall comply with the requirements of C language for variables. Particular attention shall be paid to the following points:

1. Variable name is case sensitive.
2. Variable name cannot be a number, or started with a digit, or contains special characters like blank and backslash.
3. Variable name cannot be any reserved keyword of C language.

In the above example, set the properties of the LW0_R as follows:

In the window, select “**signed short**” for **Data Type**, **R** for **R/W**, “**LW**” for **Address Type**, and “**0**” for **Address**. Click **OK**, and the variable is registered in the **Macrocode Variable Window**.

Data type	Param name	PLC Station...	Reg-Addre...	Address	No of Word	OptMode
signed short	LW0_R	0	LW	0	1	Read



Note: While compiling macrocodes, all referenced external data must be registered in the **Macrocode Variable Window** in advance.

Use the same method to set LW1_R and set the address to LW1. The properties of LW2_W are set as follows:

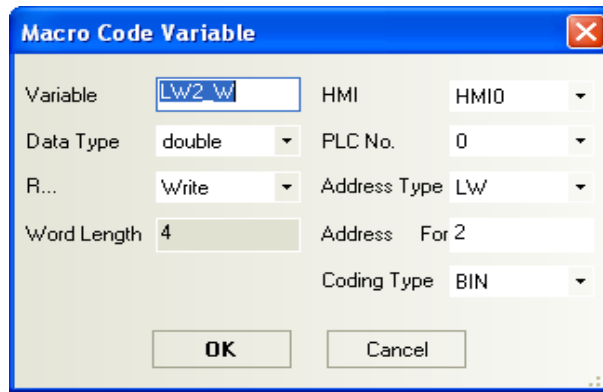

Caution: Select “double” for **Data Type**, and the **Word Length** changes to “4” automatically, that is, the variable occupies LW2~LW5.

After setting, the variable window is shown as follows:

Data type	Param name	PLC Station...	Reg-Addre...	Address	No of Word	OptMode
signed short	LW0_R	0	LW	0	1	Read
signed short	LW1_R	0	LW	1	1	Read
double	LW2_W	0	LW	2	4	Write

After defining the variable, compile the codes as follows:

```
int MacroEntry()
{
//LW0 divided by LW1, is LW2
    LW2_W=LW0_R/LW1_R;
    return 0;
}
```

Save it to disk, and the compilation of the macro is completed. The system returns to configuration editing window. Edit the following parameters:

Place two numeric input components, corresponding to LW0 and LW1 respectively;

Place a static text and enter “/” to indicate a division operation;

Place a numeric display component, corresponding to LW2. Select “**Double**” for **Data Type** (. Both integer place and decimal place are 4;

Place a function key, execute the macro, and select “**macro_0.c**” in the drop-down list box, and enter “=” in the (**Tag**) tab, as shown below:

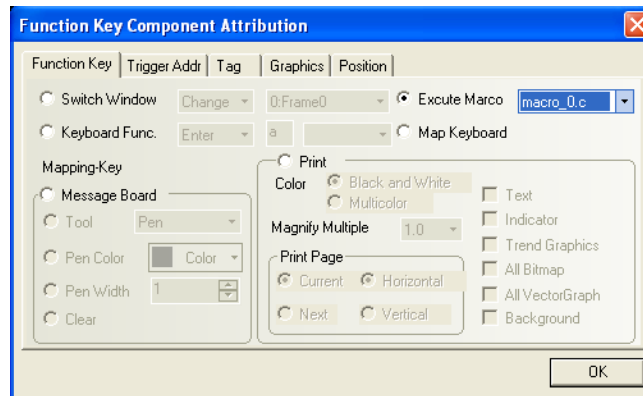

The configuration window is shown as follows:

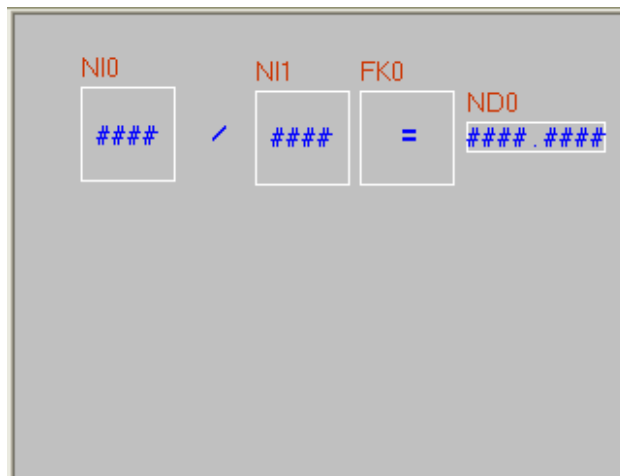

Perform offline simulation and enter “5” and “2” in LW0 and Lw1 respectively, and press “=” to obtain the result as follows:

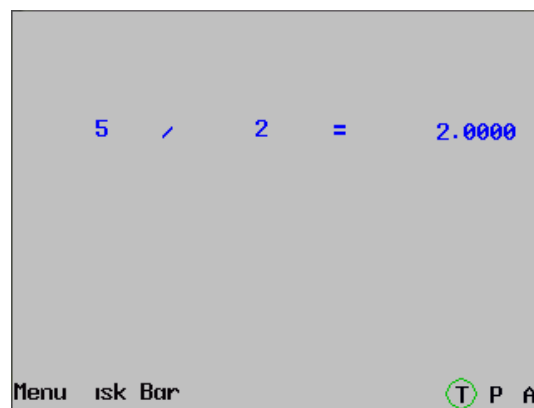

According to our estimation, the result shall be 2.5 instead of 2. What is the problem? If the user is familiar with the C language, he will be aware of the reason quickly. Because the data type for LW0_R and LW1_R is “**short**”, according to the default type conversion principle of C language, the division result will be rounded off to an integer. How to solve the problem? It is simple: just convert an input value into the type of “**double**”:

```
LW2_W= (double)(LW0_R) / LW1_R;
```

After modifying the macro, conduct simulation again, and the result will be:

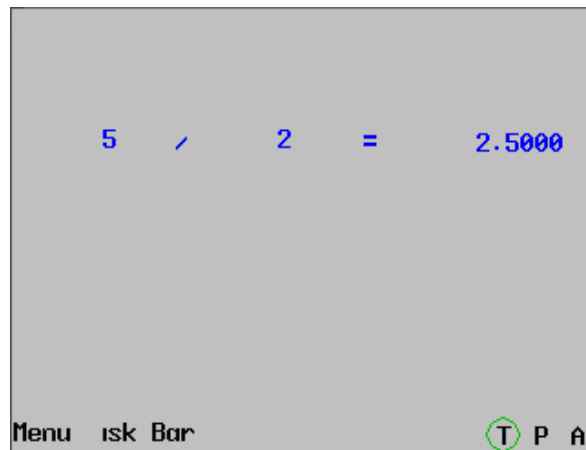

This simple example is complete. However, this segment of codes still has a problem: What if the LW1 input is 0? We all know the number 0 cannot be a divisor. In the C language, if a number is divided by 0 in an operation, it will cause the error of “division by zero overflow”. In severe circumstance, it may lead to program deadlock or exit. The macro will encounter the error of “division by zero overflow” and affect normal operation of the system. What shall we do then? We have to check the operand.

Modify the codes as follows:

```
int MacroEntry()
{
    //Judge whether LW1 is 0, preventing division by zero overflow:
    if ( LW1_R != 0)
        //LW0 divided by LW1, is LW2
        LW2_W=(double)(LW0_R)/LW1_R;
    return 0;
}
```

Run the macro again. If the divisor is 0, the macro will not conduct the division operation, thus enhancing the robustness of the codes.

9.2 Operating Principles of Macro Template and Read/Write Variable

As shown in the above section, you may gain a preliminary understanding of the creation and use of the macro template. In this section, we will introduce the operating principles of the macro template and the precautions in the use of the macro template.

A macro template can be regarded as a black box with input and output. Taking the example in the section 9.1 for example, the model is as follows:

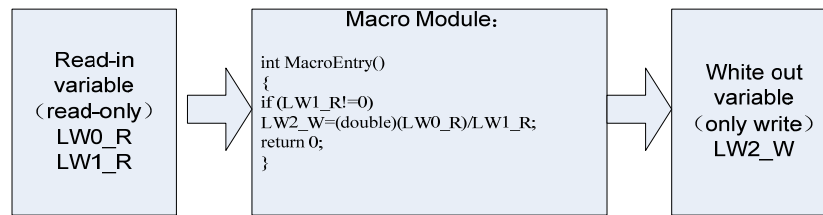

The execution principle is as follows: Before the module executes the macro, it obtains register values of LW0 and LW1 and assigns them to the read variables LW0_R and LW1_R, and then runs the macro template. After the macro function is returned, it will write the variable value of LW2_W to LW2.

Therefore, macro template inner variable is only a copy of the register. Modification of the variable value does not mean modification of register value.



Note:

1. The macro template does not read register value in real time; instead, it reads the value at the beginning of the macro template operation. Therefore, during the operation of the macro template, changing the register value externally does not affect the operation results of the macro template.
2. The value of the macro template is not written in real time. Therefore, the variable value assigned during the operation of the macro template will be written into the macro template only when the operation comes to an end.
3. The read variable is read-only and the write variable is write-only. Therefore, assigning value for read variable or reading the value of write variable by macrocode is invalid operation. Likewise, if an address has to perform read and write operations, it must correspond to two different variable names, for example, LW0 corresponds to LW0_R and LW0_W.
4. A macro template can define temporary variables or arrays or even complex associations. However, it cannot set global variables or static variables. To use a global variable to save data, it is necessary to use a local address like LW, LB, and so on.
5. The register served as output must be assigned a value.



Note:

1. Modify or delete variables in the macros

In the **[Project File Window]**, find the corresponding macro and enter the macro variable window. Select a data type, right click, and then select to add, delete or modify the variable.

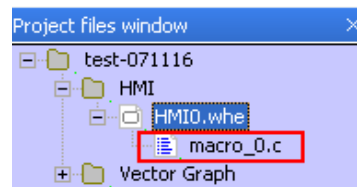

Double click enters "Macrocode" window!

A deleted variable cannot be recovered, so be cautious on this operation.

2. Deleting a complete macro file

In the [Project File Window], select a corresponding macro and click [Delete].

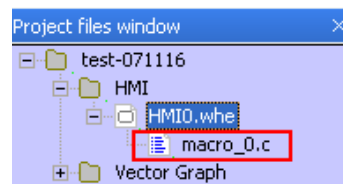

Pitch on , press down the "delete" key

A deleted macro file cannot be recovered, so be cautious on this operation.

9.3 Triggering of Macro

In the EV5000, macros can be triggered flexibly in multiple modes. Flexible use of macro triggering modes can conveniently implement more flexible and powerful functions.

Presently, the EV5000 supports the following macro triggering modes:

1. System initialization macro:

Select the [Initialization Macro] check box in the [HMI Attribution] tab shown in the following window. The initialization macro will be triggered upon system startup to implement such functions as setting initial values of registers and transferring recipes.

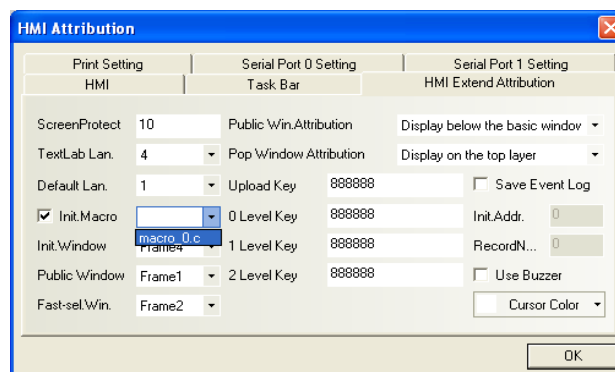

2. Function key triggered macro:

Use the "Execute Macrocode" function of the function key to trigger macros, which is a

common triggering mode.

3. Timer triggered macro:

Use the “**Execute Macrocode**” function of the timer to trigger macros. The macro can be combined with the timer trigger to implement multiple triggering modes of register triggering, timing triggering, and window initialization triggering.

4. PLC control macro

Set the PLC control component as shown below. Select the “**Execute Macro Instruction**” option. In this way, a segment of macrocodes can be executed when a PLC register is set to 1.

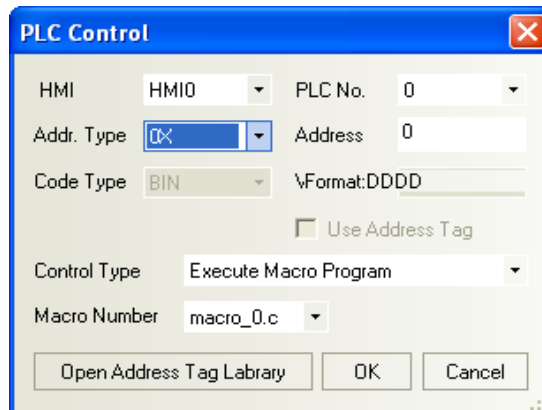

5. Event triggered macro:

Set the event triggered macro as shown below. In this way, a segment of macrocodes can be triggered when a condition is satisfied.

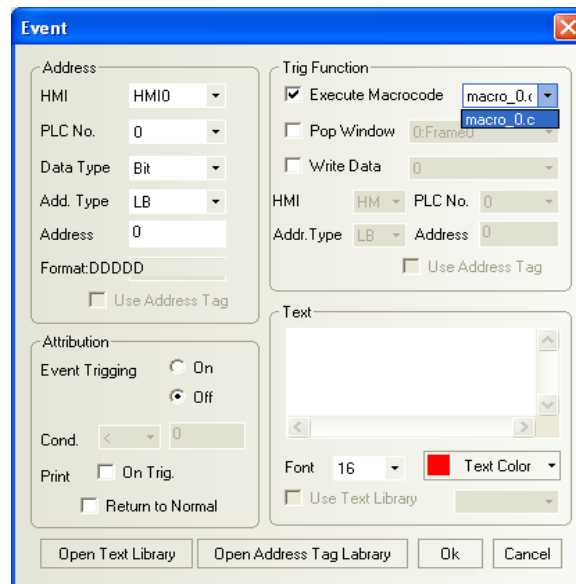

9.4 Examples

The following sections will present a further explanation on macros with several interesting

examples.

Example 1: Touch Screen Bouncing Ball

In this example, it uses macros to implement the moving of a ball in a display area. The ball will be bounced back when it touches the border of the display area. The moving speed of the ball can be adjusted. (Note: The data in this example is applicable to 5300L/S/T projects. In case of 5400 or 5500, enlarge the size to 640×480.)

Firstly, add a vectogram BALL.VG and draw a “bouncing ball” with a round shape. If you have a more vivid picture, just import it.

Place a moving part in the upper-left corner of the screen; set the address to LW0 and select “move along X and Y axes”, with the maximum value of 320 and the minimum value of 0; select the vectogram BALL.VG;

Place two value setting components and select to set them when the window is open; set LW3 and LW4 to 5;

Place four state setting components used to increase/decrease the value of LW3 and LW4.

The planned register space is as follows:

LW0: State of the moving shape component, always 1;

LW1: Displacement of the moving shape along X axis

LW2: Displacement of the moving shape along Y axis

LW3: Moving speed along X axis

LW4: Moving speed along Y axis

◆ Creating a macro:

Define the following variables as shown in the figure below:

Parameters						
Data type	Param name	PLC Station...	Reg-Addre...	Address	No of Word	OptMode
signed short	lw1_r	0	LW	1	1	Read
signed short	lw1_w	0	LW	1	1	Write
signed short	lw2_r	0	LW	2	1	Read
signed short	lw2_w	0	LW	2	1	Write
bit	direction_x_r	0	LB	0	1	Read
bit	direction_x_w	0	LB	0	1	Write
bit	direction_y_r	0	LB	1	1	Read
bit	direction_y_w	0	LB	1	1	Write
signed short	speed_x	0	LW	3	1	Read
signed short	speed_y	0	LW	4	1	Read

Compile the following codes:

```
#define MAX_X 260 //Maximum displacement along X axis
#define MAX_Y 180 // Maximum displacement along Y axis
#define MIN_X 0 // Minimum displacement along X axis
#define MIN_Y 0 // Minimum displacement along Y axis
```

```
int MacroEntry()
{
//direction: 0—increase, 1--decrease
if(direction_x_r)
    {//decrease
    lw1_w = lw1_r - speed_x;
    if(lw1_r < MIN_X)
        {
        lw1_w = MIN_X;    //Prevent “out-of-bounds”
        direction_x_w = 0;    //Change direction
        }
    }
else
    {//increase
    lw1_w = lw1_r + speed_x;
    if(lw1_r > MAX_X)
        {
        lw1_w = MAX_X;
        direction_x_w = 1;
        }
    }

if(direction_y_r)
    {//decrease
    lw2_w = lw2_r - speed_y;
    if(lw2_r < MIN_Y)
        {
        lw2_w = MIN_Y;
        direction_y_w=0;
        }
    }
else
    {
    lw2_w = lw2_r + speed_y;
    if(lw2_r > MAX_Y)
        {
        lw2_w = MAX_Y;
```

```

        direction_y_w = 1;
    }
} return 0;
}

```

Finally, add a timer component as set below:

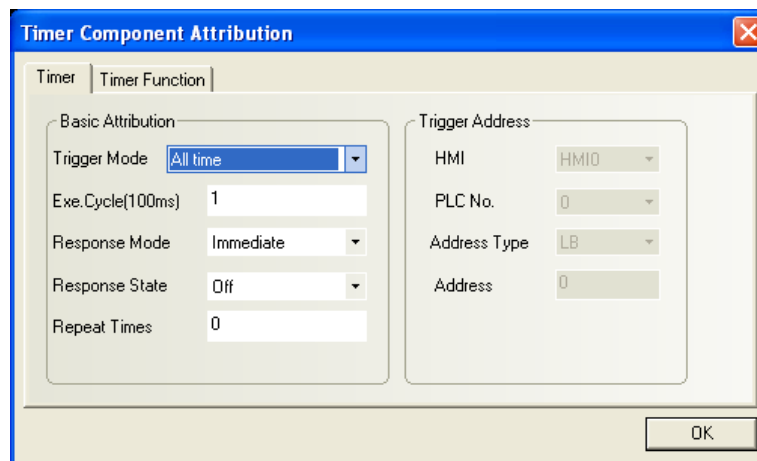

Select **“Execute Macrocode”** in the **[Timer Function]** tab and then select the compiled macrocode.

Upon completion, the configuration interface is shown as follows:

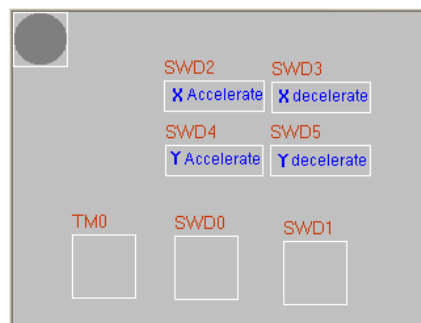

Run the macro and perform offline simulation. The ball moves in the screen. Adjust the speed at different directions and its moving track and speed change.

We can see from this example that, to implement continuous change of a certain register, the repeat revocation of macro instructions must be used and the input and write variables for the register to be operated must be defined.

Example 2: Domino

In this example, use a macro template to trigger the next macro template to implement a sequential operation. In this way, a sequence of “dominoes” will be fallen down or erected in

sequence. Firstly, draw a shape of a domino, that is, vectogram in two states: one vertical rectangle and one horizontal rectangle, and name the shape as BRICK.VG, as shown below:

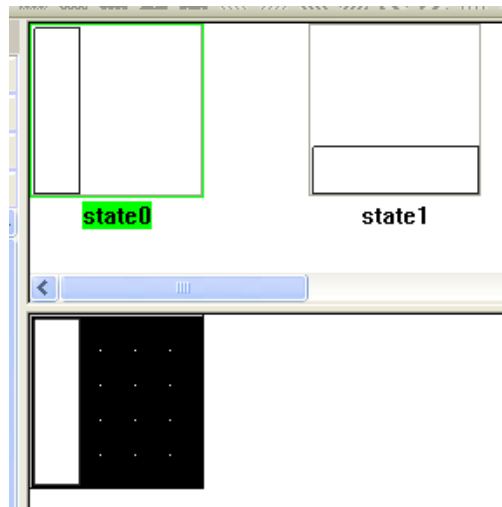

Make six lamp components, with their addresses as LB1~6 respectively. Use the vectogram BRICK.VG. The configuration is shown in the figure below:



Make six timer components to be triggered by registers, with the triggering addresses as LB100~LB105 respectively. Taking LB100 for example, the timer setting is as follows: Select "Triggered by register state" for [Trigger Mode], ON for [Response State], and "Execute immediately" for [Response Mode], and 1 for [Repeat Times]. Since it is triggered once and immediately, it is not necessary to pay attention to execution cycle.

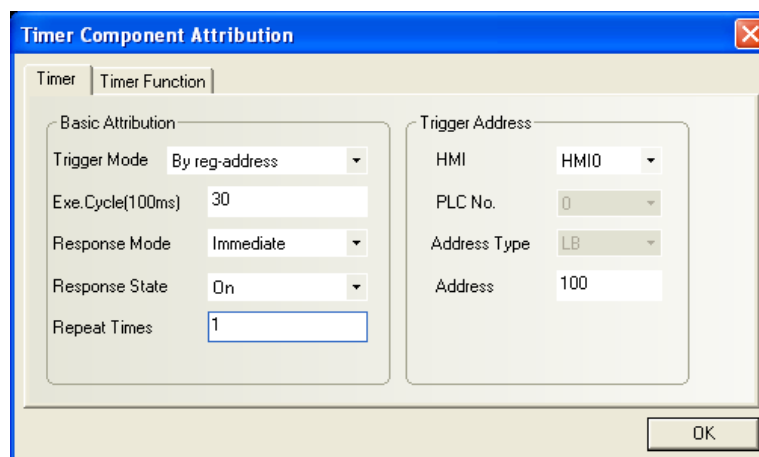

Then, we make six macro templates, which are to be triggered by the above-mentioned six timer

components in sequence. LB100 triggered timer corresponds to macro_0.c, LB101 triggered timer corresponds to macro_1.c, and so on.

The codes of macro_0.C are to change the state of the first domino. The codes are as follows:

```
int MacroEntry()
{
    LB1_W = !(LB1_R);
    LB101_W = 1;
    return 0;
}
```

The variable is defined as follows:

Parameters						
Data type	Param name	PLC Station...	Reg-Addre...	Address	No of Word	OptMode
bit	LB101_W	0	LB	101	1	Write
bit	LB1_W	0	LB	1	1	Write
bit	LB1_R	0	LB	1	1	Read

When macro_0 is triggered, it will change the state of LB1 and set LB101 to 1, which will then triggers macro_1. The macro_1 will change LB2 and set LB102 to 1. macro_2 ~ macro4 will be set in a similar way.

Macro_5 is different. Its codes are as follows:

```
int MacroEntry()
{
    LB6_W =!(LB6_R);
    LB100_W=1;
    return 0;
}
```

That is, macro_5 will trigger macro_0.

Make a bit setting component and set LB100 to ON. Change the label to **[START]** to trigger the first timer.

The edited configuration window is shown below:

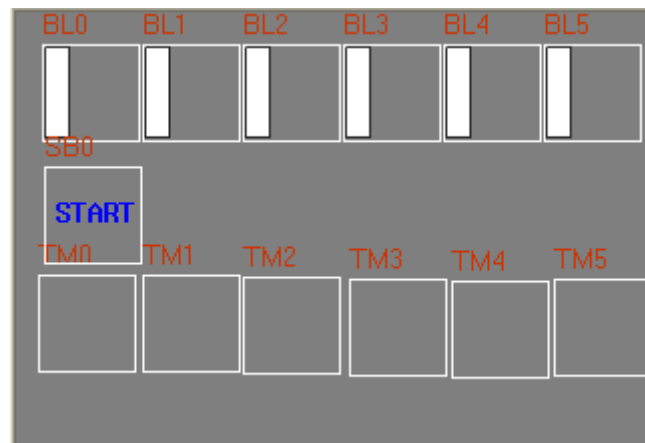

Perform simulated operation and click [**START**]. The dominos will fall down one by one from left to right, and then will erect one by one from right to left. The speed is quick without intervals.

In the [**Timer**] tab, select “**Delay**” for [**Response Mode**], and **10** for [**Execution Cycle**], as shown below:

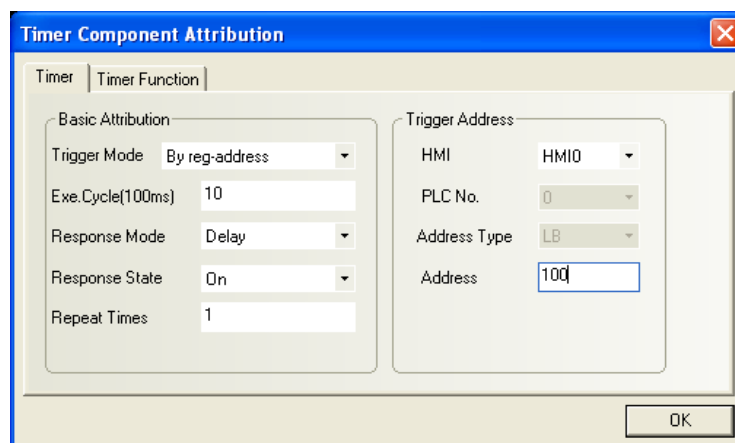

Compile the codes and run the macros again. We can see that the dominos will be fallen down or erected after a delay of 1 second.

We can see from the above example that the timer triggered macros can be used to conduct sequential operations to implement sequence and time control and to flexibly achieve desirable results.

Chapter 10 Print

The print function is often used in the eView MT5000/4000. In this document, there are two types of print operations: One is the print through the Windows system, and the other is the print through the touch screen. This chapter describes only the print with the touch screen. To use the print function with the touch screen, it is necessary to enable the printer in the **Print Settings** tab in the **HMI Properties** window. After that, the MT5000/4000 will display a dedicated print window (therefore, if the print function is selected, a maximum of five pop-up windows can be displayed at the same time). You can view the print window in the PLC Monitor of the online simulation, offline simulation, and indirect online simulation auxiliary functions, as shown below:

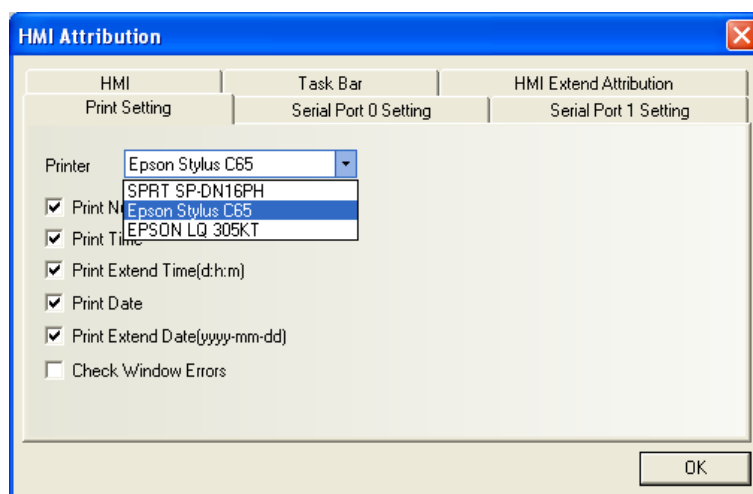

MT5000/4000 supports the connection with EPSON ESC/P2 printers or other compatible printers.

MT5000/4000 supports the following print modes:

1. Print text
2. Print pointer
3. Print trend graph
4. Print all bitmaps
5. Print all vectograms
6. Print background color

The print function may be used in the following circumstances: Function key, screen printout and report output controlled by PLC, and event print, as detailed below.

10.1 Function Key

Click the [**Function Key**] and the following window appears. In the window, select the **Print** option.

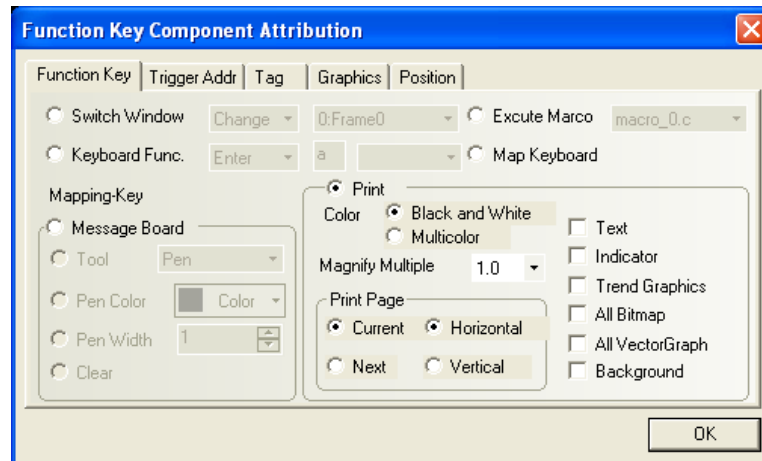
**(Printer Color) :**

The user can select **(Mono)** or **(Color)**.

(Zoom): The value range is 1.0~ 2.0.

(Page Range):

(Current Page/Next Page): Select the page to be printed.

(Landscape/Portrait): Select the print mode.

(Print Content):

1. **(Print text)**
2. **(Print meter)**
3. **(Print trend graph)**
4. **(Print all bitmaps)**
5. **(Print all vectograms)**
6. **(Print background color)**



Caution: When you select the **(Next Page)** option in the **(Page Range)** frame, the printer will skip the current page and start printing from the next page.

The print function key can be used to print screen data conveniently. The data is outputted from the standard printer port as graphics.

10.2 Screen Printout

The background component **(PLC Control)** → **(Screen Printout)** uses a bit address to control the printout of the current screen. The printout of the current screen starts when the bit address changes from **OFF** to **ON**.

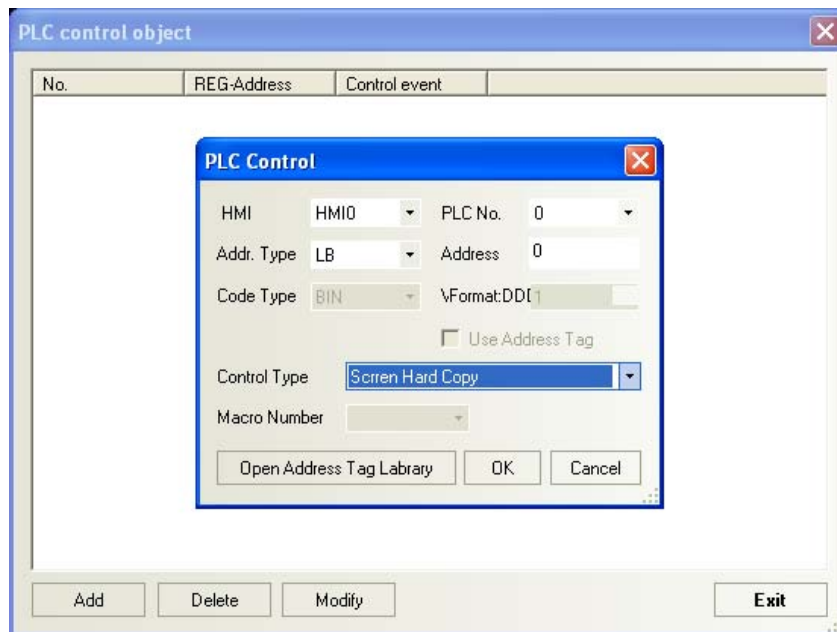

As shown in the above figure, if LB0 is set to control the **(Screen Printout)** operation, when LB0 changes from **OFF** to **ON**, the current screen will be printed out. Upon the completion of printout, the LB0 automatically returns to **OFF**.

The print format is controlled by LW9054. When the LW9054 are the following numbers, it will perform corresponding print operations.

0. Print text
1. Print meter
2. Print trend graph
3. Print all bitmaps
4. Print all vectograms
5. Print background color

10.3 Report Output

The background component **(PLC Control)→(Report Output)** uses a word address to control the printout of a designated window. The printout of the screen starts when the entered value of the word address is a valid window number. Upon the completion of printout, the value of the word address changes to **0**.

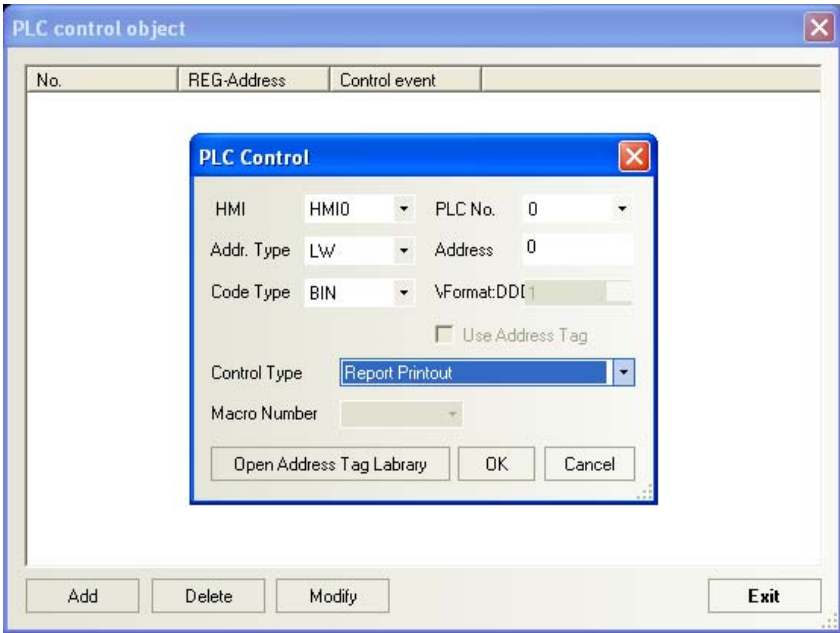

As shown in the above figure, if the value of LW0 is set to 4, the contents in window 4 will be printed out. Upon the completion of printout, the LW0 automatically returns to 0. To print out a window by the **(Report Output)** function, the system will not switch to the window to be printed. The print format is also controlled by LW9054. For control functions, refer to the description given earlier in this document.

10.4 Event Printout

When the user enters events in the **(Event Entry)** background component, the user can set trigger printing. The corresponding contents will be printed out when the set condition is triggered.

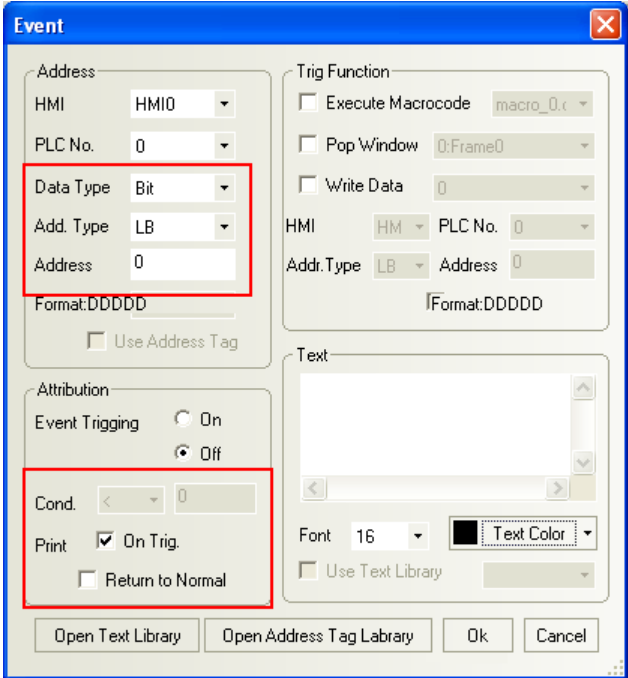

If the [位] (**Bit**) option is selected in the **(Data Type)** drop-down list box, as shown in the above

figure, and when the **(Print when triggered)** check box is selected, the system will print out the contents when the LB0 changes to **ON**. When the **(Print when resumed)** check box is selected, the system will print out the contents when LB0 returns to **OFF**.

If the [字] **(Word)** option is selected in the **(Data Type)** drop-down list box, the following window appears.

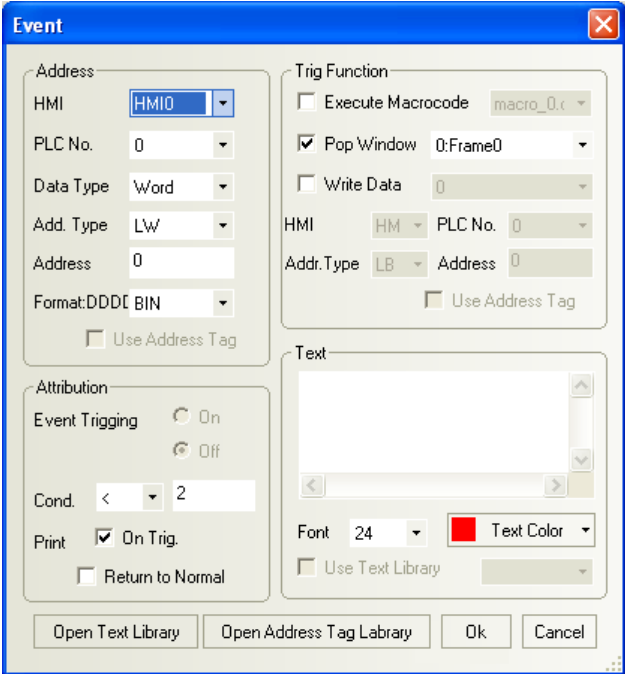

When the **(Print when triggered)** check box is selected, the system will print out the contents when the value of LW0 is less than 0. When the **(Print when resumed)** check box is selected, the system will print out the contents when LB0 resumes normal (that is, greater than or equal to 0).

10.5 Printing Failure

Printing error detection function is provided in the **(HMI Properties)** window.

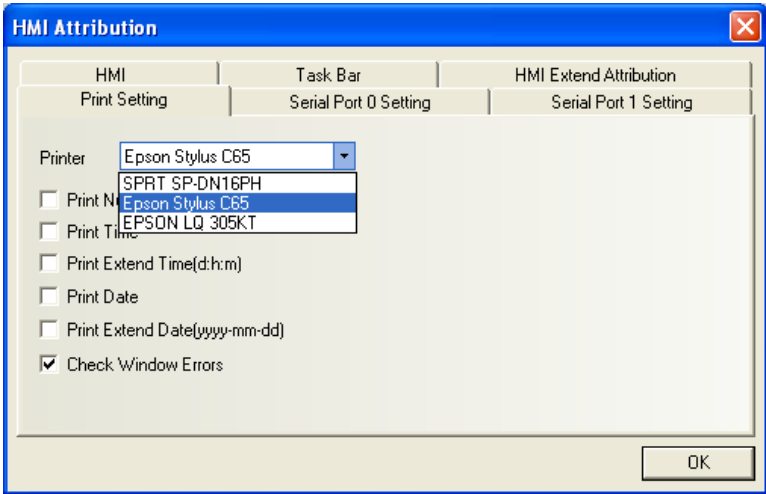

When the printer encounters an error, the following dialog box appears.



When the printer has an error, set LB9016 to **ON**.

The LB9017 can control the on/off status of the printer. When the LB9017 is set to ON, the printer will be disabled.

Chapter 11 Reserved Register Addresses of the System

The system reserves some areas of Local Word (LW), Local Bit (LB) and Recipe Word (RW) for special purposes. The user must use these addresses according to related description.

- **Local Bit(LB):** Reserved range: LB9000~9999
- **Local Word(LW):** Reserved range: LW9000~9999
- **Nonvolatile Local Word:** Reserved range: LW10000~10256

11.1 Local Bit (LB) registers reserved

Note: The letter R and W indicates the available operation for the address; R means readable and W means writable. So a register with the mark (R/W) can be read and write.

Address	Description	Remark
9000~9009	Set ON during initialization	These bits can be used to initialize some components to be ON upon system startup (R/W)
9010	Recipe download indication	The bit address can be used to indicate the download progress of the recipe. In the process of download, it is set to ON ; upon completion of download, it is set to OFF (R)
9011	Recipe upload indication	The bit address can be used to indicate the upload progress of the recipe. In the process of upload, it is set to ON ; upon completion of upload, it is set to OFF (R)
9012	Recipe download/upload indication	These bit addresses can be used to indicate the download/upload progress of the recipe. (R)
9013	Touch screen indicator	Set it to ON when touching the Touch Screen Indicator (R)
9014	CPU indicator	Set it to ON when touching the CPU Indicator (R)
9015	Alarm indicator 灯	Set it to ON when touching the Alarm Indicator (R)
9016	Printer error indication	It is set to ON in case of a print error and to OFF if printing is normal (R)
9017	Printer control	To disable the print function, set it to ON ; to enable the print function, set it to OFF (In the system parameters, all printing options must be set to ON first; otherwise, this bit address is invalid) (R/W)
9018	Enter screen saver status	When the system enters screen saver (backlight and energy saving), the bit is automatically set to 1; when the system exits the screen saver, it is set to 0.
9019	Exit screen saver status	When the system exits screen saver (backlight and energy saving), the bit is automatically set to 1; when the system

		enters the screen saver, it is set to 0.
9020	Brush (it is set to ON when the brush is selected)	Message board function, determines whether the brush is currently selected (R/W)
9021	Eraser (it is set to ON when the eraser is selected)	Message board function, determines whether the eraser is currently selected (R/W)
9022	Block Cleanout ((it is set to ON in the clearing area status)	Message board function, determines whether the clearing area function is currently selected (R/W)
9030	Brush width is 1 pixel	Message board function, set brush width to 1 pixel when the bit is set ON(R/W)
9031	Brush width is 2 pixels	Message board function, set brush width to 2 pixels when the bit is set ON(R/W)
9032	Brush width is 3 pixels	Message board function, set brush width to 3 pixels when the bit is set ON(R/W)
9040	Hide/display Fast Selection Window	Hide the Fast Selection Window if it is set to ON and display the Fast Selection Window if it is set to OFF (R/W).
9041	Hide/display taskbar	Hide the taskbar if it is set to ON and display the taskbar if it is set to OFF (R/W).
9042	Hide/display task buttons	Hide the task buttons if it is set to ON and display the task buttons if it is set to OFF (R/W).
9043	Hide/display all (Fast Selection Window, taskbar, task buttons)	Hide the Fast Selection Window, taskbar and task buttons if it is set to ON , and display all these contents when it is set to OFF (R/W).
9044	Save communication settings to the system	When it is set to ON, the system will write communications parameters saved in the LW10000 area back to the E ² PROM on the panel mainboard. The parameters will be available in the next startup only when they have been written back to the E ² PROM.
9045	Restart touch screen	The panel will be restarted when this bit is set to ON (W)
9046	Low security level	It is set to ON when the system switches from a lower security level to a higher one (R)
9050	Restore factory settings	When the bit is set to ON, the system will save the default global parameters in the downloaded data files to the LW10000 system parameter area. Upon successful execution, the system will automatically clear the bit.

9051	Enable/disable touch function when backlight is disabled	Set this bit ON will disable the touch function when the backlight is off. (R/W)
9052	Disable the return value function of PLC Control→ Change Basic Window	To disable the value return function of the PLC, set this bit to ON, but it is applicable only to the return value control in PLC Control→ Change Base Window . When the value of the LB9052 is OFF, and the return value function is not disabled, to switch from Base Window 10 to Base Window 12 with the PLC Control→ Change Base Window function (read address is D20), this switchover can be implemented only when the value of D20 is 12. After the system switches to Base Window 12, the PLC will automatically return the number 12 to the word address D21. If the return value function is disabled, the system will not return the number 12 to D21 (R/W).
9055	Disconnect: PLC	Clear this bit will make all commands for writing into the PLC invalid. When this bit is set ON, all writing operations can be performed. It serves as a logic switch for connecting and disconnecting the panel with PLC.
9056	Disconnect: Touch	Clear this bit will enable the touch function. When this bit is set ON, the touch function is disabled and it would not respond to any touch operation. It serves as a logic switch for the touch function.
9060	Keypad control bit, the pop-up of the keypad is controlled by the component in the left part of the window	When a user enables the numeric input or text input function, the MT5000/4000 set this bit to ON , and the direct window including a keypad will appear. After successful entry or pressing [ESC], this bit will be set to OFF . The user can use this bit to control the keypad. After successful entry or cancellation, the keypad window will close automatically (For details of the keypad control bit, refer to the notes following the table) (R).
9061	Keypad control bit, the pop-up of the keypad is controlled by the component in the left part of the window	For usage of LB9060~LB9069, LB9080 and LB9081, refer to the notes following the table) (R).
9062	Keypad control bit,	(R)

	the pop-up of the keypad is controlled by the component in the upper-left part of the window	
9063	Keypad control bit, the pop-up of the keypad is controlled by the component in the lower-left part of the window	(R)
9064	Keypad control bit, the pop-up of the keypad is controlled by the component in the right part of the window	(R)
9065	Keypad control bit, the pop-up of the keypad is controlled by the component in the right part of the window	(R)
9066	Keypad control bit, the pop-up of the keypad is controlled by the component in the upper-right part of the window	(R)
9067	Keypad control bit, the pop-up of the keypad is controlled by the component in the lower-right part of the window	(R)
9068	Keypad control bit, the pop-up of the keypad is controlled	(R)

	by any component of the window	
9069	Keypad control bit, the pop-up of the keypad is controlled by any component of the window	(R)
9080	Keypad control bit, the pop-up of the keypad is controlled by the component in the upper part of the window	(R)
9081	Keypad control bit, the pop-up of the keypad is controlled by the component in the lower part of the window	(R)
9091	Increase LCD contrast	
9092	Decrease LCD contrast	
9093	Increase backlight brightness	
9094	Decrease backlight brightness	
9100	Used to switch input method in the case of Pinyin input method	When the value of LB9100 is 1, the system switches to Pinyin input method; when the value is 0, the system switches to English input method.

Keypad control bit:

The whole screen of the MT5000/4000 is divided into four equal parts, as shown below:

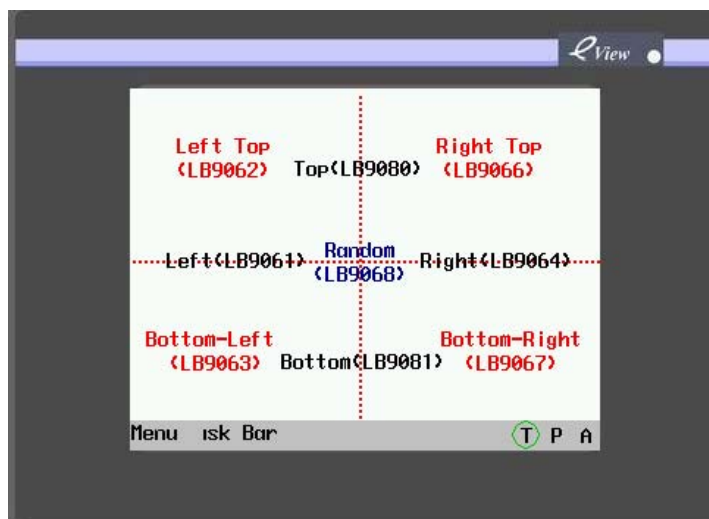

When LB9060 is used to control the keypad and if text input or numeric input in the left part of the screen is triggered, the keypad will appear in a direct window. In general, the direct window is designed to appear in the right part of the screen, so it will not overlap the input component in the left. Likewise, when LB9080 is selected and the text input or numeric input in the upper part of the screen is triggered, the direct window including the designated keypad will appear.

11.2 Local Word (LW) registers reserved

Address	Description	Remark
9000~9001	Recipe data index address (R/W)	RWI and RBI use this two words to store index address for accessing recipe data; the lower word is 9000 and the higher word is 9001. (R/W)
9002~9003	upper limit of the numeric input part	It indicates the maximum input value when the numeric input is activated; it is set to 0 when the numeric input is not activated. (R)
9004~9005	lower limit of the numeric input part	It indicates the minimum input value when the numeric input is activated; it is set to 0 when the numeric input is not activated. (R)
9006	Message board operation mode	Message board function, select current operation tool on the message board: 0: Brush, 1: Eraser, 2: Block Cleanout (R)
9007	Brush definition	Message board function, select the width for the brush: 0: 1 pixel; 1: 2 pixels; 2: 3 pixels (R)
9008	Brush color (0~255 corresponding to 256-color standard color palette)	Message board function; the user can select any color among 256 colors by entering a number (R)

9020	Interference	When the lower byte of this LW register is not zero, the value will be sent as an INT byte in MEMORY_LINK protocol (value range 0x20-0xFE), after successful sending, the byte will be cleared to 0.
9034~9035	System time (in the unit of 0.1 second)	Double word. Displays the time in the unit of 0.1 second (R)
9040~9041	Security level password	Double word. Refer to related part in Chapter 12, Security Level. (W)
9042	Security level	Display the security level of the current Base Window. Refer to related part in Chapter 12, Security Level. (R)
9043	Forced switchover of security level	Forced switchover from a higher level (for example, level 2) to a lower level (for example, level 0). Refer to related part in Chapter 12, Security Level. (W)
9050	Base Window number	Number of base windows of the touch screen are saved here. The salve machine can maintain the same base window with the master machine according to the word (using PLC control component) (R)
9054	Report output format	0: Text & meter & trend graph, 1: Text & meter & trend graph & vectogram, excluding templates, 2: Text & meter & trend graph & bitmaps, 3: Text & meter & trend graph & bitmaps & vectograms, excluding templates, 4: All (R/W)
9057	Size of each item in event entry message base	Size used by the recipe memory to store each item of the event entry message base (R)
9058~9059	Size of event entry message base	Size used by the recipe memory to store the event entry message base, including management message (R)
9060~9075	Numeric input & text input	LW9075 includes the recently entered data (Numeric Value or Text) (R)
9100 9101	Change address: Applicable only to the external PLC	9100 stores the window number. 9101 stores the offset of PLC address. When LW9100 is set to 11 and LW9101 is set to 20, the PLC word addresses of all components in window 11 will be added with an offset of 20, that is, D10 changing to D30, and all bit addresses will be added with an offset of $20 \times 16 = 320$, that is, M20 changing to M340.
9150	In the case of Pinyin input method, used	The value of LW9150 is the serial number of the Chinese character displayed in the current Chinese window

	to turn the window with Chinese characters	
9152~9167	In the case of Pinyin input method, used to displayed the currently entered Pinyin characters	
9170	Used to scroll in notepad component	The value indicates the starting line of the input area
9130	Contents of online switching text base, the value indicates text base index	
9140	Display brightness level	Used by MT4000 series to display brightness level
9141	Display contrast level	Used by MT4000 series to display contrast level

11.3 Nonvolatile Local Word (LW10000~10256)

RTC		
Address	Description	Remark
10000	RTC second	BIN code, value range 0~59 (R/W)
10001	RTC minute	BIN code, value range 0~59 (R/W)
10002	RTC hour	BIN code, value range 0~23 (R/W)
10003	RTC date	BIN code, value range 0~31 (R/W)
10004	RTC month	BIN code, value range 0~12 (R/W)
10005	RTC year	BIN code, value range 0~9999 (R/W)
10006	RTC day	BIN code, value range 0~6 (R/W)
Note on RTC:		
A user can display system time with corresponding component, with its value writable. However, the user has to make sure its value must be within the value range. For example, the second cannot be written as 78 (BIN). If it is written as 78, RTC will continue the sequence as 78 79 80..., which may result in unpredictable errors.		

Mapping of other system parameters (Note: changes on these registers will take effect after restarting the panel)

System parameter settings:		
Address	Description	Remark
10010	Startup window number	0~65535
10011	Screen saver time setting(backlight and energy saving)	Set to 0 will disable the screen saver, Value larger than 0 will enable the screen saver, The valid range is 1-600 (minute). If the value is 10, the panel will enter screen saver after 10 minutes with no touch operations.
10012	Buzzer	0: Disable 1: Enable
10013	Common window/pop-up window	0: Normal 1: shown above other windows
10014	Common window/properties	0: Below base window 1: Above base window
10015	Number of stored events	0~65535
10016	RTC source	0:PLC (Local Word) 1: Internal RTC
10017	Default language	0~3

Security Level Mapping		
Address	Description	Remark
10020	Use security level setting (#1)	0: Disable 1: Enable
10022~10023	Password/level 0 (#1)	Occupy double words
10024~10025	Password/level 1 (#1)	Occupy double words
10026~10027	Password/level 2 (#1)	Occupy double words

Communication Parameter Mapping		
Address	Description	Remark
10030~10033	IP address (#1)	Each WORD occupies a field, with a value range of 0~255
10034	Port number (download port number) (#1)	It is to save the download port number instead of the communication port number
10035	Reserved	
10036	mode of COM0	
10037~10038	Baud Rate	Double word
10039	Word Length	

10040	Parity	
10041	Stop bit	
10042	HMI station number(when HMI is used as a slave device)	
10043~44	PLC Communication Time out	
10045~46	Protocol Time out 1	
10047~48	Protocol Time out 2	
10056	mode of COM1	
10057~10058	Baud rate	double word
10059	word length	
10060	parity	
10061	Stop bit	
10062	HMI station number(when HMI is used as a slave device)	
10063~64	PLCCommunication Time out	
10065~66	Protocol Time out 1	
10067~68	Protocol Time out 2	

#1: If LB9044 is set to ON, communication settings will be written back to the system E²PROM, including IP address and port number.

If LB9050 is set to ON, some system parameters will be restored to factory default settings.

Note:

1. When the local addresses exceed 10000, the system does not support dynamic modification function in simulation mode; however, the addresses can be read.
(For example, the address is LW10005 and the offline simulation displays as 2006. However, the value cannot be modified in the offline simulation mode, and it can be modified when run on the actual panel.)
2. The offline simulation mode does not support backlight control function.
3. The offline simulation mode does not support the use of video components.
4. The offline simulation mode does not support print function.

Chapter 12 Security Level

Security level is used to set different access rights for different users, and only the user with high-level password can access windows with high security levels, which greatly enhances the security of application projects.

In the **(Window Properties)** window, there is a **(Security Level)** option. In other words, we can set the security level for any window, as shown below:

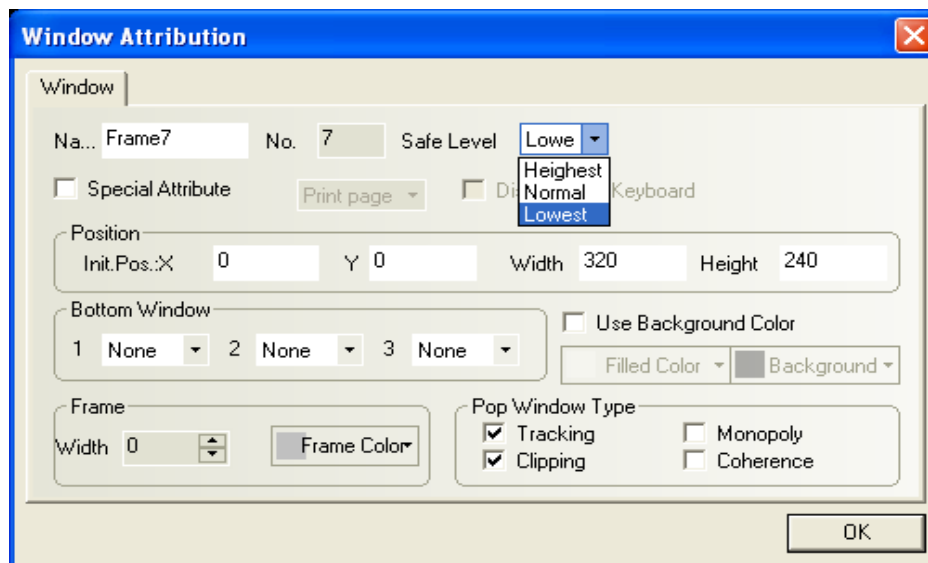

Please note that the security level setting is valid only for base windows and not available for other windows. A project has three security levels, namely, high (2), medium (1), and low (0). When creating a new window, the default security level is low. In the **(HMI Properties)** window, the user can set the password for each security level. When a user is in a high security level, he can access windows with lower security levels; however, if the user is in a low security level, he cannot access windows with higher security levels. It helps to enhance security. For example, important keys can be configured in a window with high security level; therefore, a user cannot access such keys in general and can only access such contents after entering the password of high security level.

The following is an example on the use of security level. Firstly, select **(File)→(New Project)** to create a new project. Then, double click **[HMI]** in the **(Project Structure Window)**. In the **(HMI Properties)** window, click the **(Touch Screen Extended Properties)** tab and then set password for three security levels. Here, we set the password for level 1 security to 1111, as shown below.

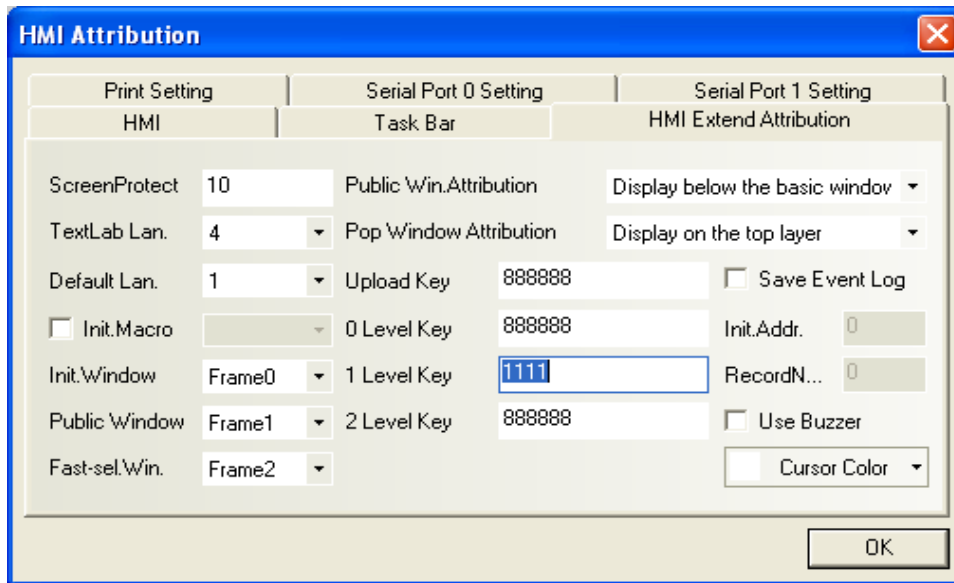

The register LW9042 is reserved by the system to display the security level of the current base window. We can only read the reserved register LW9042, but cannot write in the LW9042. Create a numeric display component and place it in window 0 to display the current security level, as shown below:

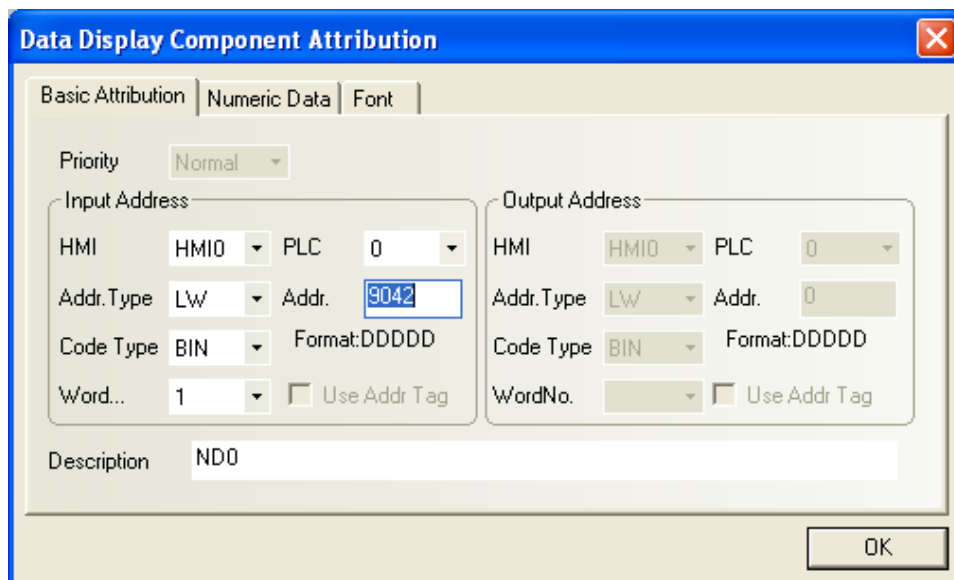

The whole project is shown in the following figure:



Save it to the disk, make compilation and then run in offline simulation mode, as shown in the figure below:



Because no password is entered, the current security level must be 0 when the project runs. Switch to window 4 and set the (**Security Level**) to (**Medium**, that is, 1) in the (**Window Properties**) window, as shown below:

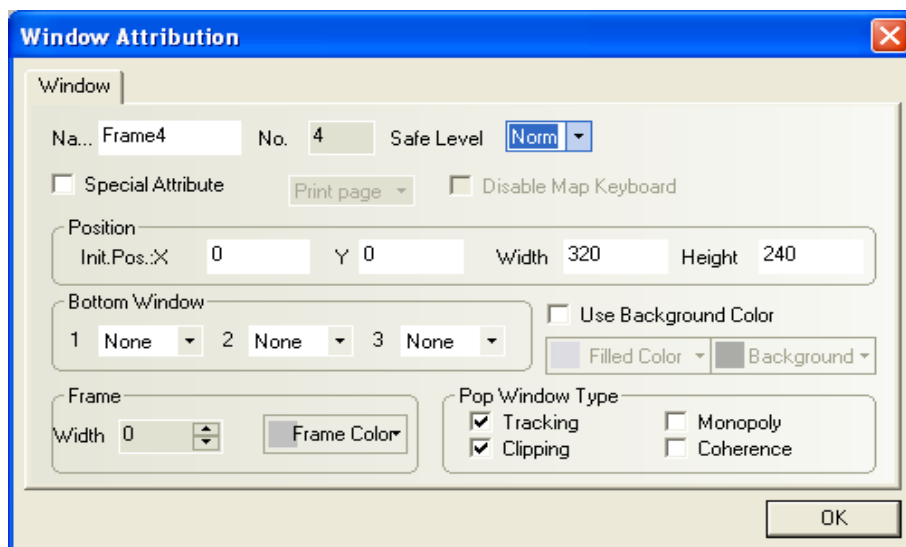

Create a function key in window 0, and its properties are designed as follows:

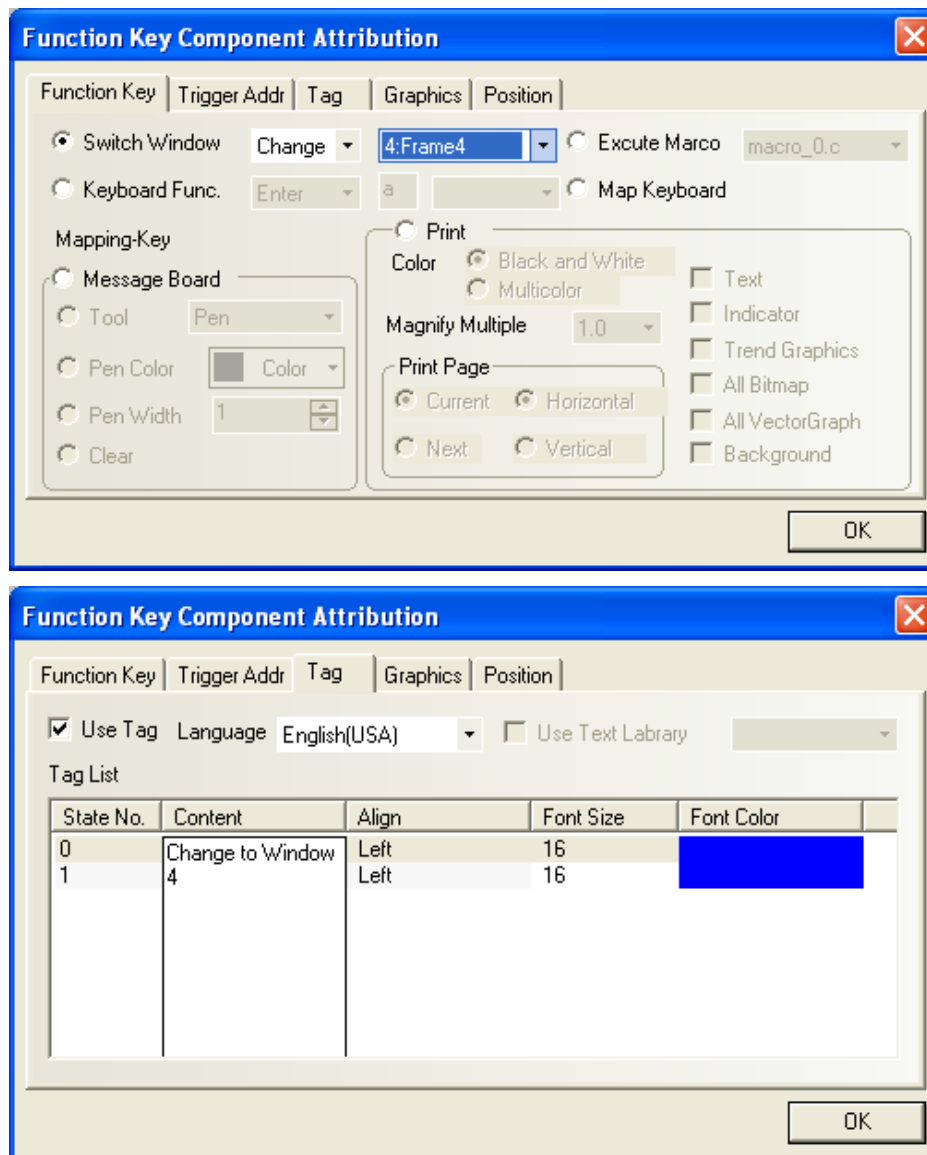

Save it to the disk, make compilation and then run in offline simulation mode, as shown in the figure below:



Press the function key, but the system fails to switch to window 4. The reason is that the current security level is 0, while that of window 4 is 1, so the user cannot access a window with higher security level from lower one. To access window 4, the user has to enter the password for the security level 1. The registers LW9040~LW9041 reserved by the system are used to enter passwords for different security levels. Add a numeric input component to window 0, as shown in the figure below:

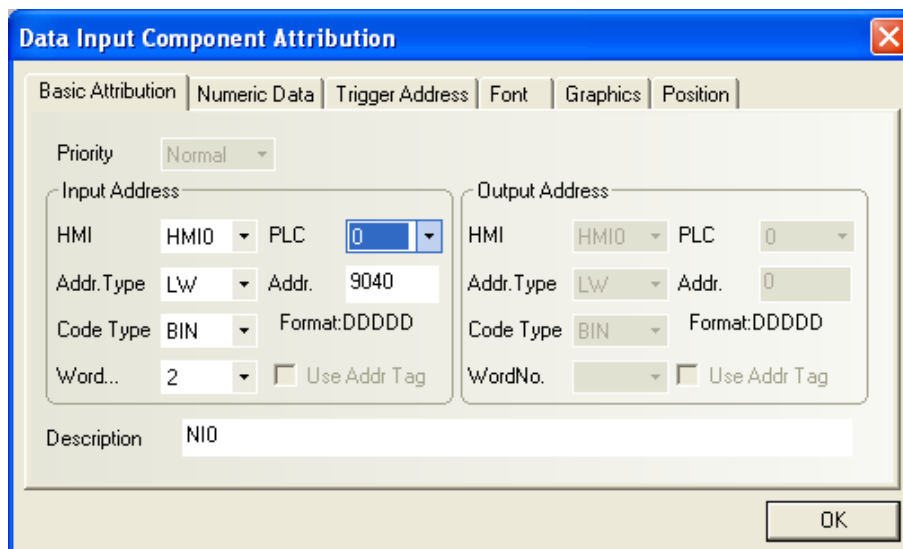

Select the [密码] (**Password**) in the (**Data Type**) drop-down list box, as shown below:

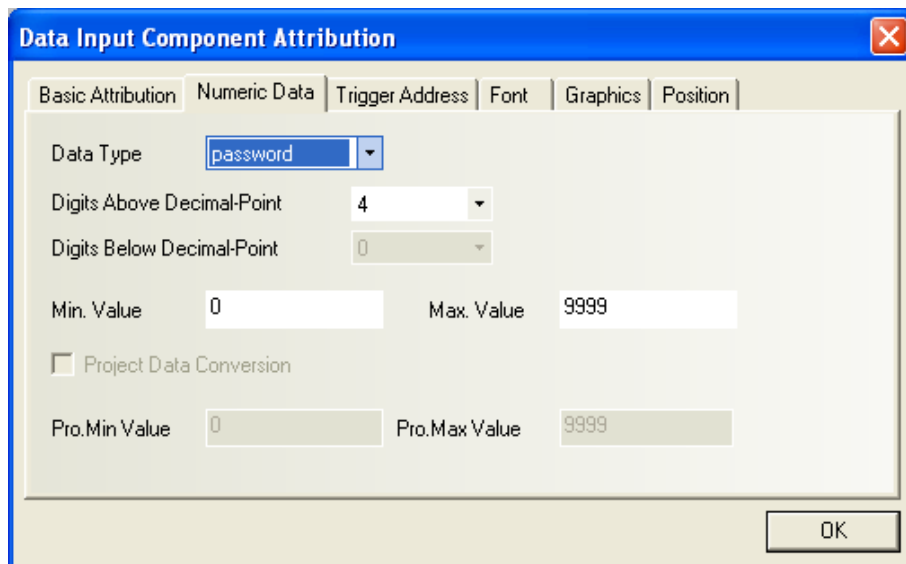

Caution: The user has to enter a security level password through the reserved registers LW9040~LW9041 of the system. Therefore, the (**Words**) must be set to 2.

Save it to the disk, make compilation and then run in offline simulation mode:



The current security level is 0, so the (**Change Window 4**) button is unavailable. Enter the password **1111**, and the current security level changes to 1, as shown in the figure below:



The current security level is now 1. Press the (**Change Window 4**) button, and the system successfully switches to window 4, as shown in the figure below:



How to change to a window with lower security level from a window with higher one? The register LW9043 is reserved by the system to switch from a higher security level to a lower security level. Add a numeric input component in window 0, as shown below:

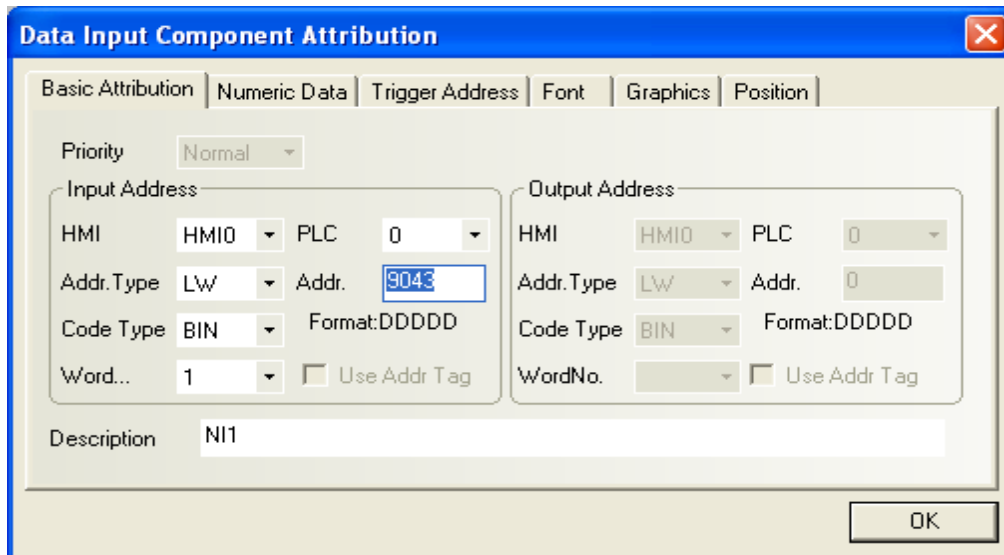

Save it to the disk, make compilation and then run in offline simulation mode:

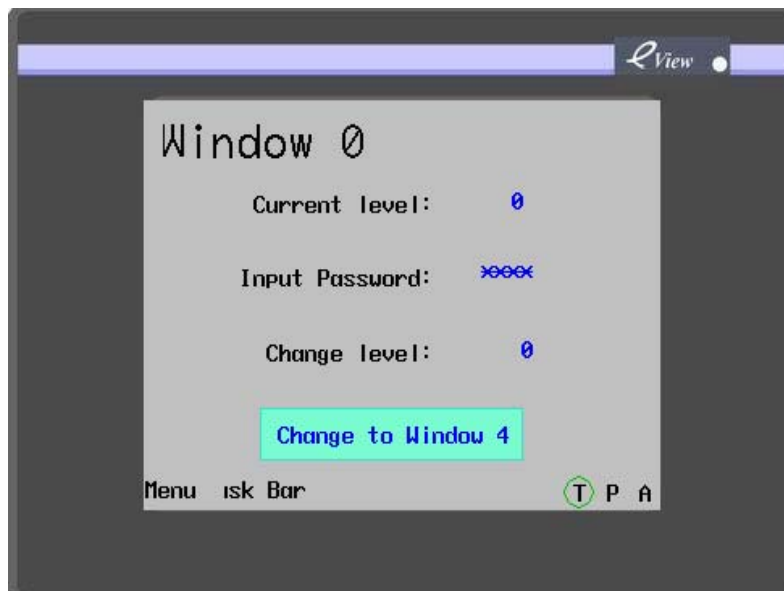

Enter 1 in the (**Change Level**) frame, but the current level will not change to 1 because it is not permitted to change a window with a lower security level to a window with a higher security level, as shown below:

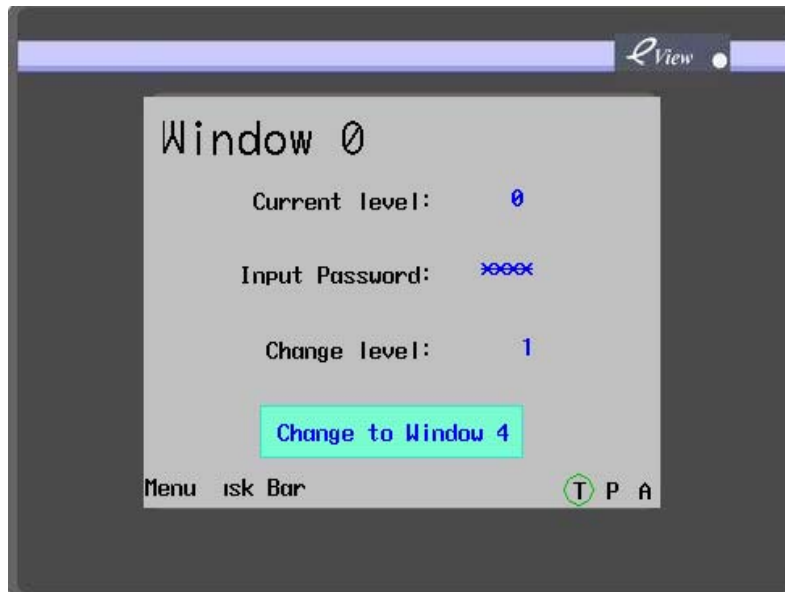

Then, enter the password **1111** to change the current security level to 1, as shown in the figure below:

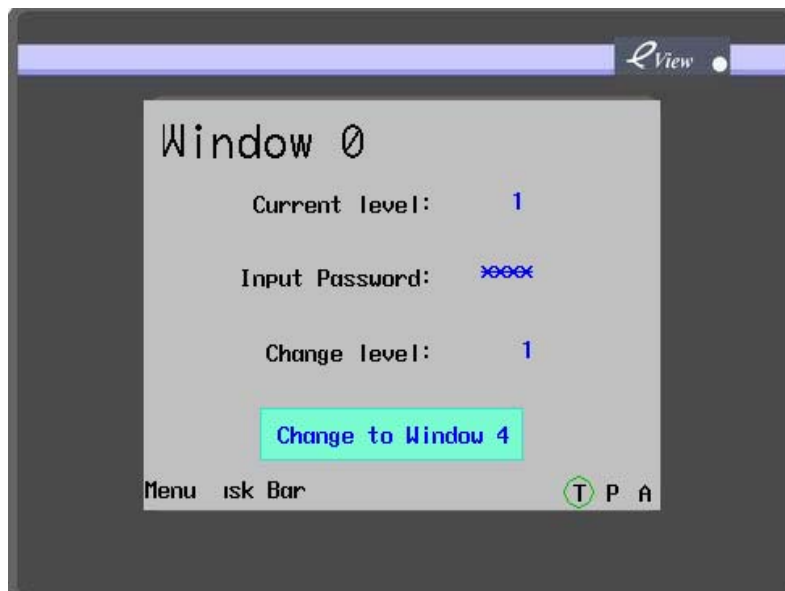

Press the function key, and the system changes to window 4. If the user enters the value 0 in the **(Change Level)** frame, the current security level changes to 0 immediately, and then, the system cannot switch to window 4, as shown in the figure below:

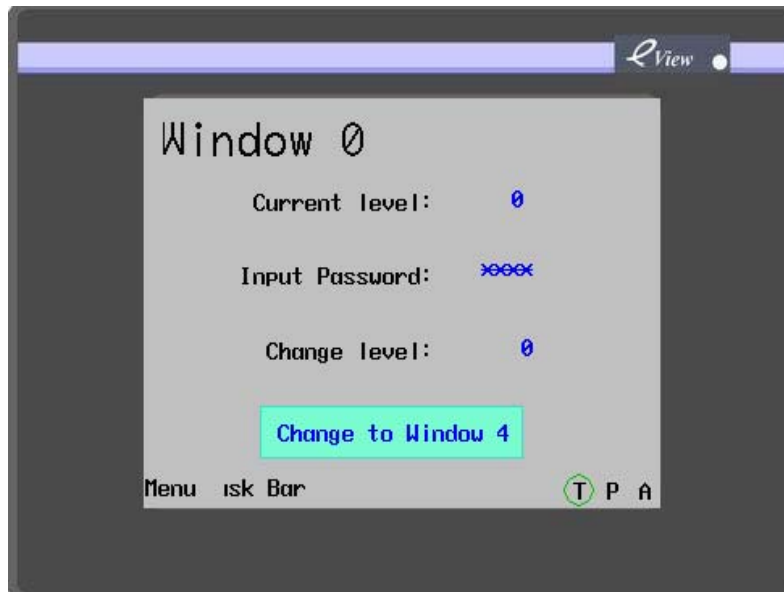

The design of different passwords for different security levels assigns different operation authorities to different operators, which enhances the security of the application system.

Uploading password is set as follows::

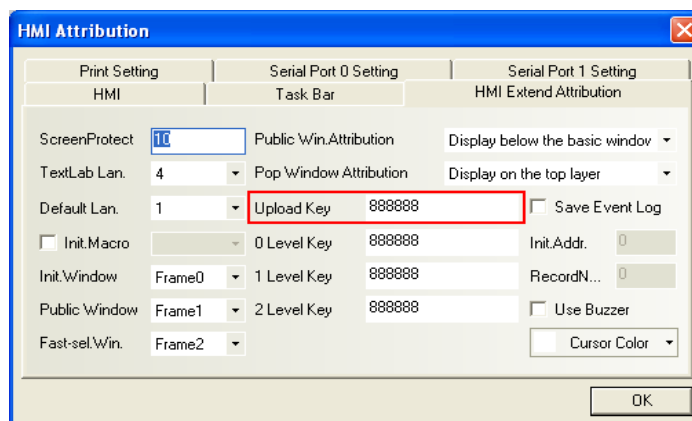

The following graphic shows how to use this uploading password: double click the EVManger, select the Upload operate, then configure the communication parameters (here default USB).

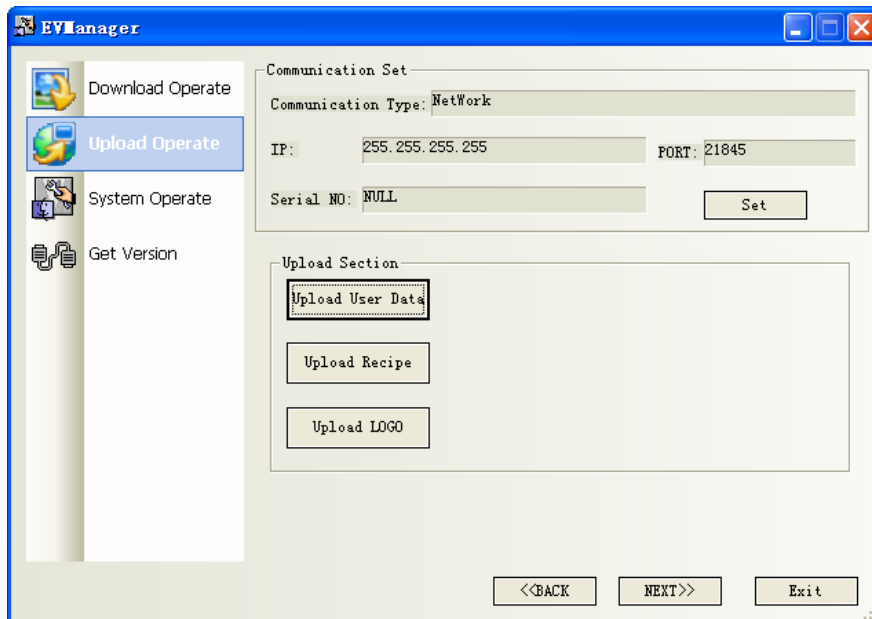

Click the button “Upload User Data”, it ejects a window for parameters to select, The HMI information can be blank or not as user want. Then select the data you care. Click the button OK, then you can get a file with the suffix .pkg. At the version 1.2.3, this .pkg file can not be uncompiled. It is used for re-download to other HMIs. The file suffixed with .logo is a picture which showed at the start 3 seconds of HMI. The third file suffixed with .rcp is a recipe database file which user configured for special application.

The following graphic shows the selection of User Data uploading.

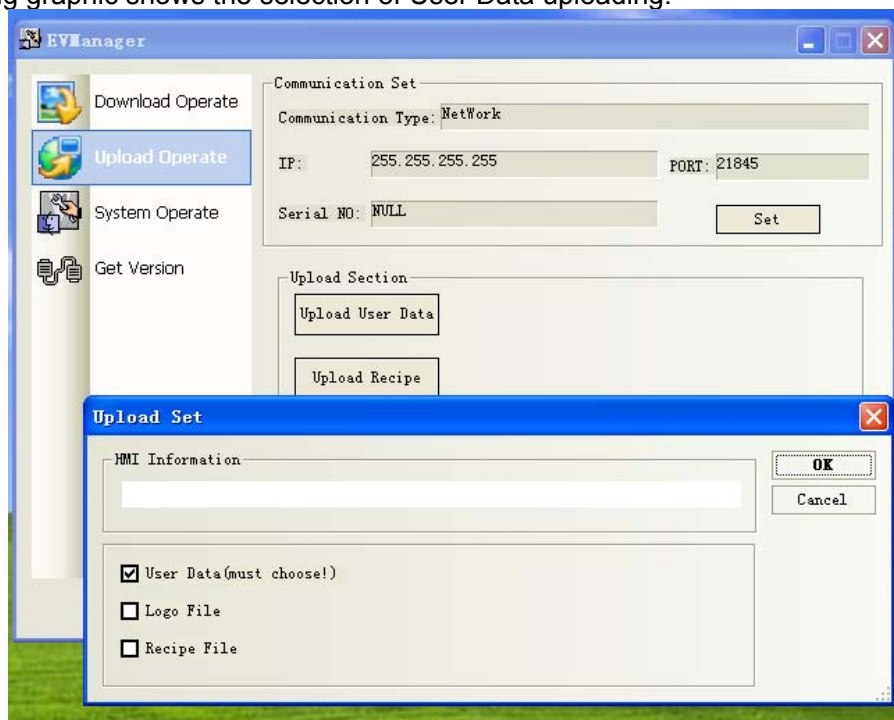

Click the button OK, then the “save as” window is ejected. Please input the name and select a right address where you want to save this file. Here we select desktop.

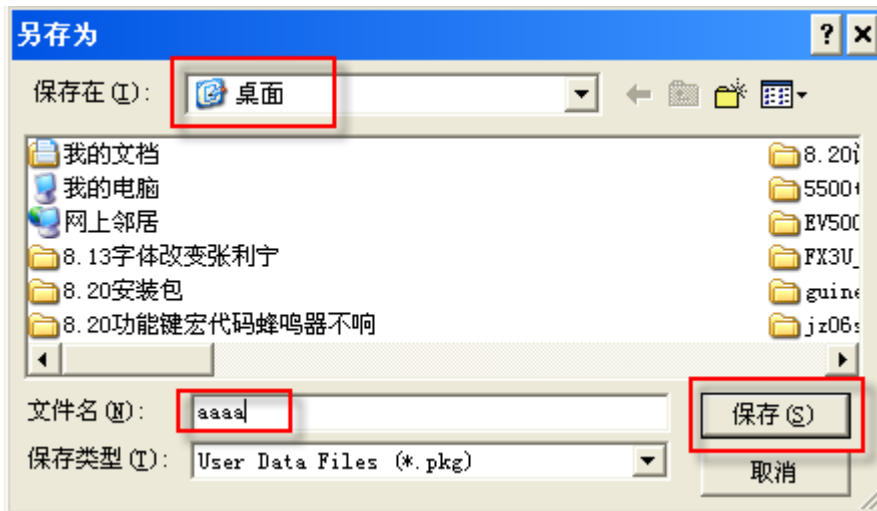

Click [保存] (save), it will eject the uploading password window as follows.

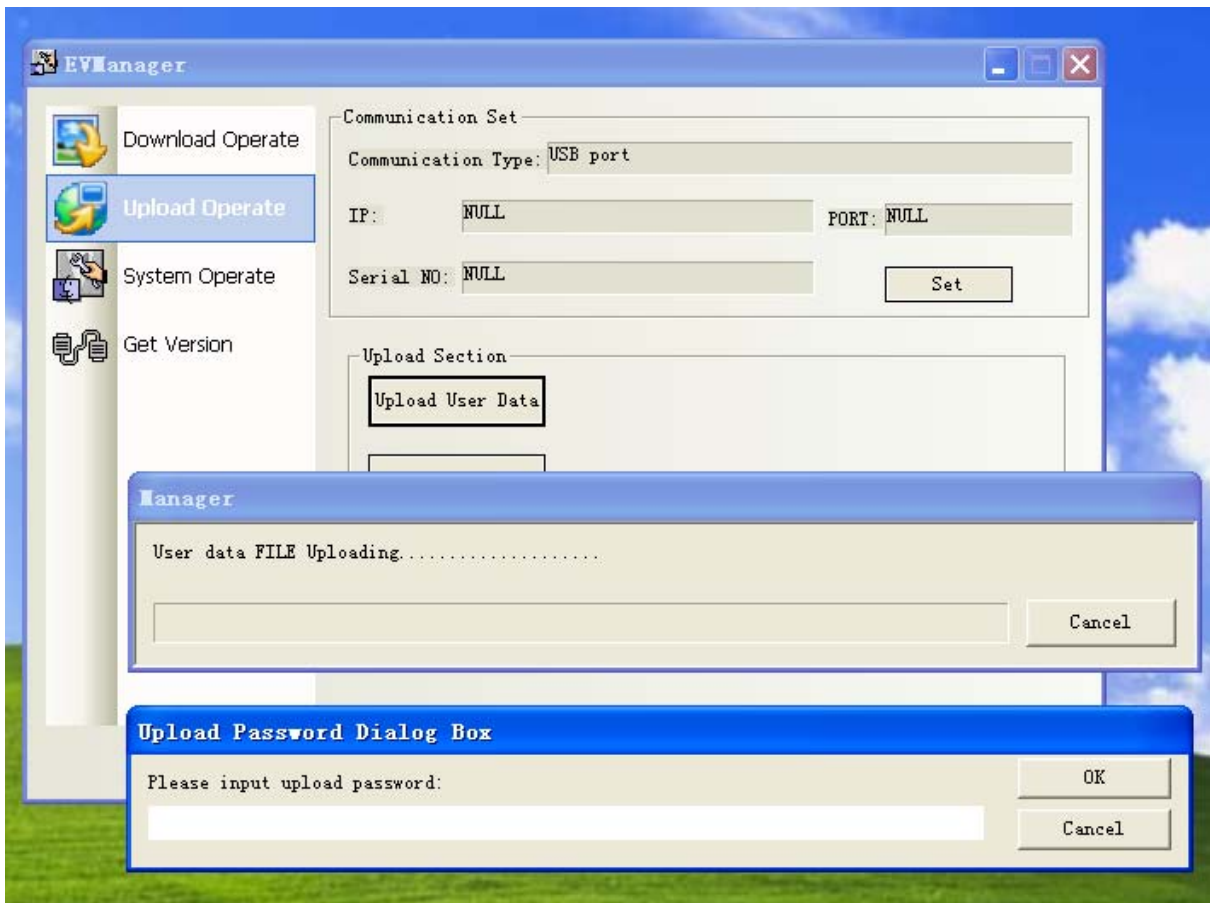

Default password is 888888, you can change this password as you like. Input the password, click the button OK.

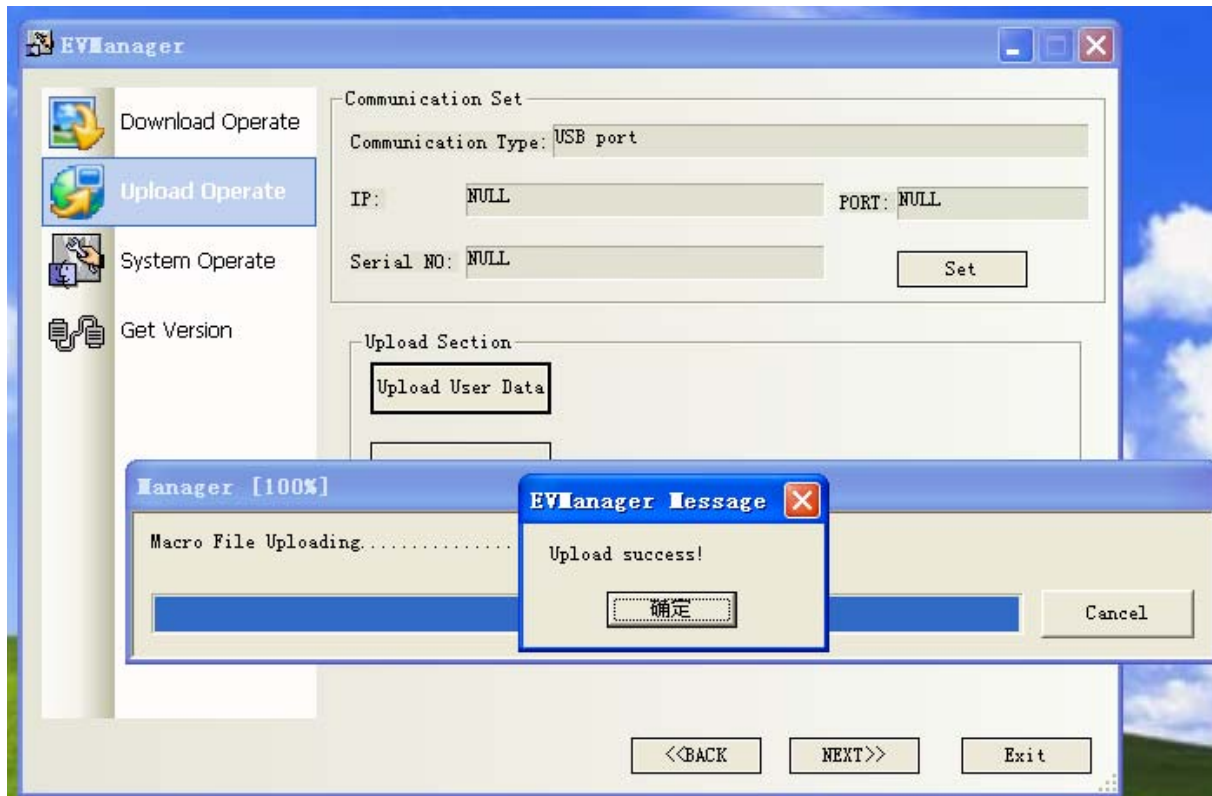

After seconds you can get the file .pkg as follows.



HOW TO USE THE .PKG FILE

Run the software EVManager, select the tab "Download Operate", configure the parameters right like the upload we did, make a choice on the downloading file you want. Here we select the file aaaa.pkg which we uploaded.

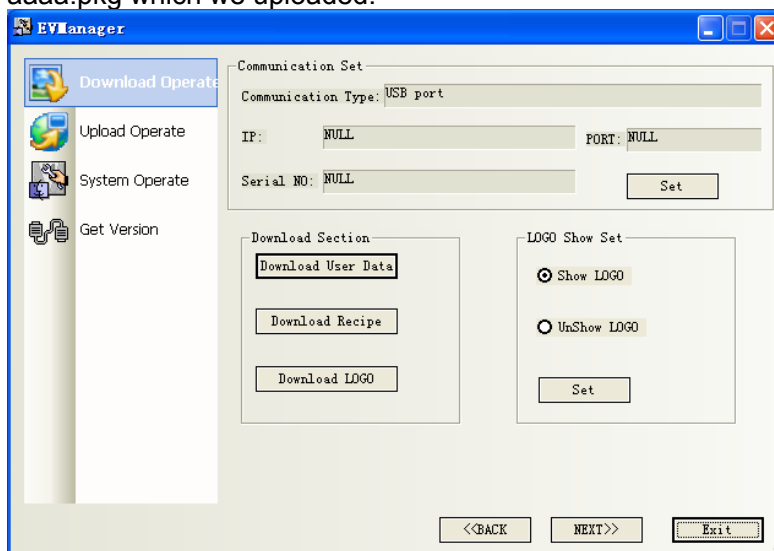

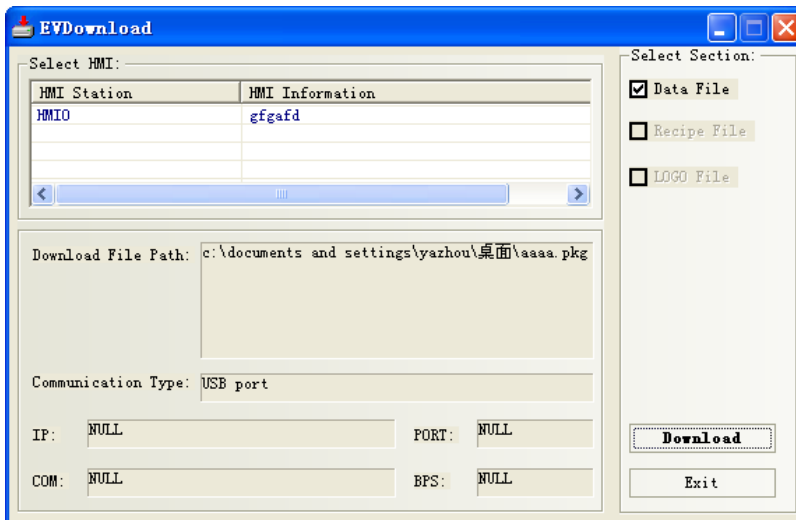

Click “Download”, the software we designed or uploaded will be downloaded automatically to HMIs.

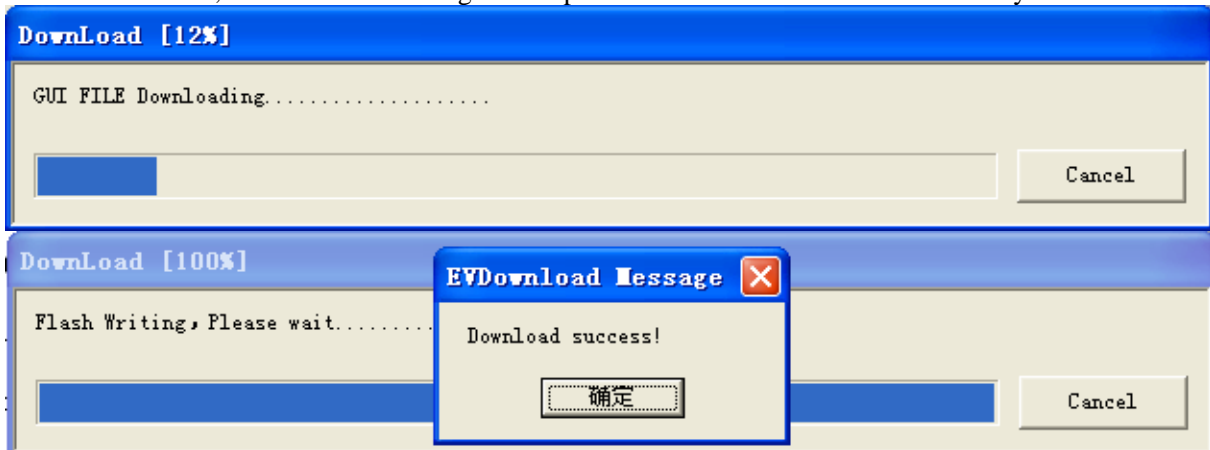

Power on the HMI, enjoy the work we did.

Chapter 13 Serial Communication

13.1 Serial Communication

Serial communication means the bit-by-bit transfer between different equipment through two data signal cables (sometimes, a control line is required). Each data bit occupies a fixed time length. This communication mode uses less data cables and features low cost.

The following is the data frame of a byte in asynchronous communications mode, consisting of start bit, data, parity bit, and stop bit.

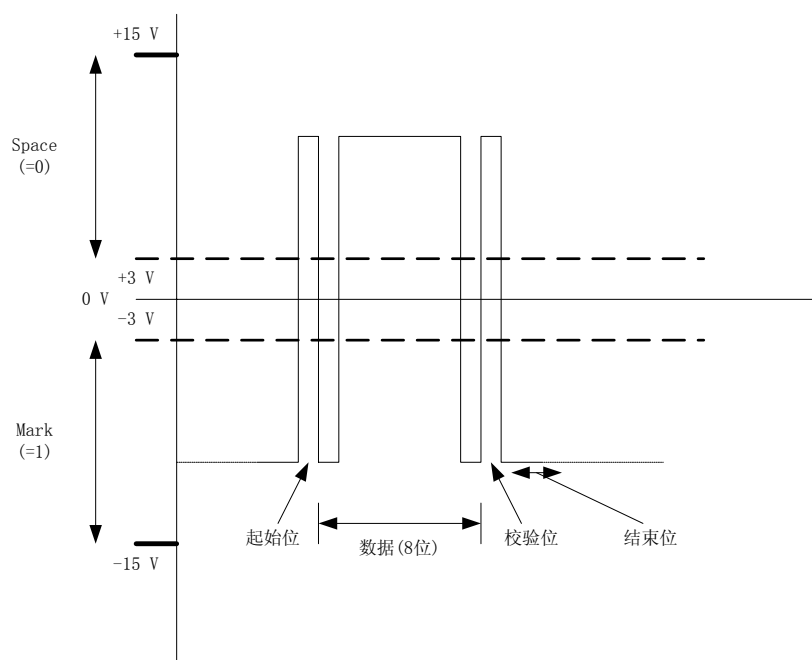

In general, logic 1 (MARK) = $-3V \sim -15V$, logic 0 (SPACE) = $+3 \sim +15V$, and each data frame (7 or 8 bits) consists of a high-voltage start bit, a low-voltage stop bit, and a parity bit. The **Bits Per Second** of data usually consists of 9600 Bit/S, 19200 Bit/S, 38400 Bit/S or 115200Bit/S.

During transmission of serial data, an error may occur due to interference. For example, the bits for the character "E" during transmission are: 0100, 0101=45H. However, due to interference, the bit may change to 1. In this case, we call it a "bit error". The method used to check errors occurred during transmission is "error detection"; the methods used to correct an error after detecting it is called "error correction". The simplest error detection method is "parity check", that is, an additional odd/even parity bit is transferred along with the bits of characters to be transferred. Either odd parity or even parity may apply.

- Odd parity: Among all bits to be transferred (including bits of characters and the parity bit), the number of all “1” is an odd number, for example:

In the 8-bit data 01100101, the number of “1” is an even number; we append a 1 to change it to an odd number, so the parity bit is 1.

In the 8-bit data 01100001, the number of “1” is an odd number; we append a 0 and it remains to be an odd number, so the parity bit is 0.

- Even parity: Among all bits to be transferred (including bits of characters and the parity bit), the number of all “1” is an even number, for example:

In the 8-bit data 01100101, the number of “1” is an even number; we append a 0 and it remains to be an even number, so the parity bit is 0.

In the 8-bit data 01100001, the number of “1” is an odd number; we append a 1 to change it to an even number, so the parity bit is 1.

When the parity check is adopted, 1-bit error can be detected, but 2-bit or high errors cannot be detected. Furthermore, detected errors cannot be corrected. Upon detection of an error, it will request for retransmission. However, since it is easy to implement, it is widely applied.

To implement communication between two parties, the settings of data bit, start bit, stop bit, bits per second and parity check for serial ports of both parties must be set to be the same.

The eView MT5000/4000 and most PLCs support only asynchronous transfer mode. Our description is also based on asynchronous transfer mode. (If you are interested in synchronous transfer mode, please refer to related documents). Certainly, entity interfaces are required as transmission media to send or receive data in asynchronous transfer mode. This is the difference between RS-232, RS-422 and RS-485, as detailed respectively below.

13.2 RS-232

Presently, RS-232 is the most widely applied serial interface in PC and communication industry. RS-232 is defined as a single-ended standard to extend communication distance in low-rate serial communication. RS-232 adopts an Unbalanced Data Transmission (UDT) interface, under which the voltage of a single cable relative to a grounding signal cable is used to indicate the logic status Mark or Space. A typical connection method is shown as follows:



Pinout of a typical RS-232 interface (PC Compatible) is shown as follows:

Pin No.	Pin Name	Description
1	Carrier Detect (CD)	
2	Received Data (RD)	Data receiving signal cable
3	Transmitted Data (TD)	Data transmission signal cable
4	Data Terminal Ready (DTR)	
5	Signal Ground	Grounding signal cable
6	Data Set Ready (DSR)	
7	Request To Send (RTS)	
8	Clear To Send (CTS)	
9	Ring Indicator (RI)	

Pinout of the eView MT5000/4000 RS232 is shown as follows:

Pin No.	Pin Name	Description
2	Received Data (RXD)	Data receiving signal cable
3	Transmitted Data (TXD)	Data transmission signal cable
5	Signal Ground	Grounding signal cable
7	Clear To Send (CTS)	CTS and RTS work only on some PLCs (Only COM1 supports CTS and RTS)
8	Request To Send (RTS)	

If without CTS or RTS, the typical connection between the eView 5000/4000/PLC [RS-232] and PLC is shown as follows:

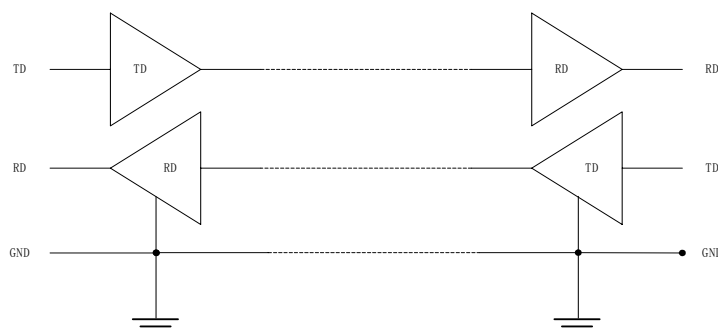

Since RS-232 adopts the full-duplex transmission mode, it has independent transmission (TD) and receiving (RD) signal cables and a grounding signal cable. The purpose of CTS and RTS is intended for handshaking control between the eView MT5000/4000 and the PLC. The CTS or RTS of only a few PLCs must be controlled by the eView MT5000/4000.

The length of RS-232 connection cable is often a question. The standard length shall not exceed 50 feet (1 foot = 30 cm), or the capacitance shall not exceed 2500 pF. Based on capacitance standard, the typical capacitance of a UTP CAT-5 connection cable is 17 pf/feet, and the maximum length of a connection cable is 147 feet (that is, about 44 m). The value may be larger in the case of a shielded cable, and the value may be smaller when the cable is used in an environment with considerable interference.

Since RS-232-C interface standard was developed in an earlier time, it has the following defects:

- (1). The signal level value of the interface is high, which may easily cause damage to chips of the interface circuitry.
- (2). The transmission rate is low, with a baud rate of 20 Kbps in asynchronous transmission mode.
- (3). The interface uses a signal cable and a signal return cable to form a common ground transmission mode. This common ground transmission may easily lead to common-mode interference. Therefore, the noise suppression and anti-interference capability is low. The higher the baud rate is, the lower the anti-interference capability will be.
- (4). The transmission distance is rather limited.

13.3 RS-422

RS-422 and RS-485 are different from RS-232. For RS-422 and RS-485, data signals are transferred in differential transmission mode, that is, balanced transmission mode. It uses a pair of twisted pair cables, with one cable defined as A and the other defined as B. In general, the positive level between the transmission drivers A and B is at +2 ~ +6V, which indicates a logic state, while the negative level is at -2 ~ 6V, which indicates another logic state. In addition, there is a signal ground C and an "Enable" end in the RS-485, while they are optional in the RS-422. The "Enable" end is used to control the connection/disconnection between the transmission driver and the transmission line. When the "Enable" end is active, the transmission driver is in a high-impedance state, that is, "the third state", a state different from the logic "1" and logic "0", as shown in the figure below:

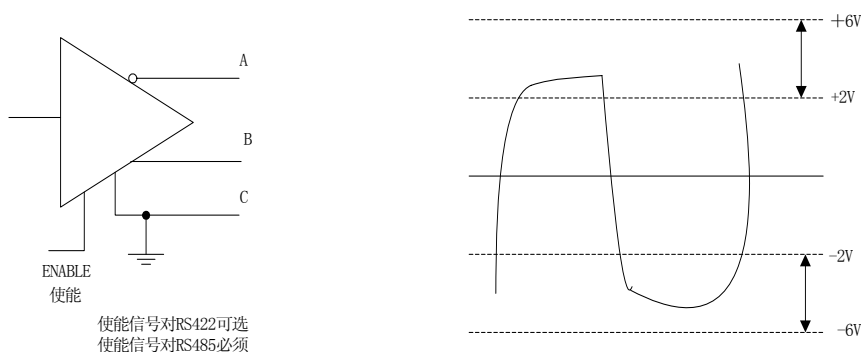

Corresponding specifications are made for the receivers. AA and BB are connected with balanced twisted pairs between the transmission end and the receiving end. When the level between AB at the receiving end is greater than +200 mV, it outputs positive logic level; when the value is less than -200 mV, it outputs positive logic level. The level range received by the receiver on the balanced cable is from 200 mV to 6V, as shown in the figure below:

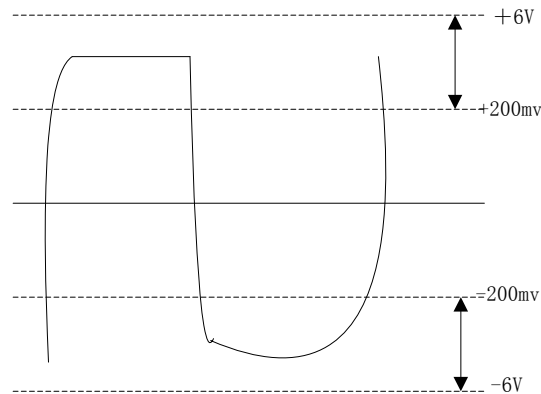

RS-422 standard stands for Electrical Characteristics of Balanced Voltage Digital Interface Circuits, which defines the characteristics of the interface circuits. The following figure shows a typical 4-wire RS-422 interface. In fact, it has another signal ground cable and totally 5 cables. Since the receiver adopts high input impedance and the transmission driver has high driving capability than RS-232 interface, a maximum of 10 receiving nodes can be configured in the same transmission cable. Among all these nodes, one is the master node and the others are slave nodes. Slave nodes cannot communicate with each other. Therefore, RS-422 interface supports point-to-multipoint bidirectional communication. Since the 4-wire RS-422 interface adopts independent transmission and receiving channels, it is unnecessary to control data direction. Any necessary handshaking between different devices can be implemented either in software mode (XON/XOFF handshaking) or in hardware mode (a pair of independent twisted pairs).

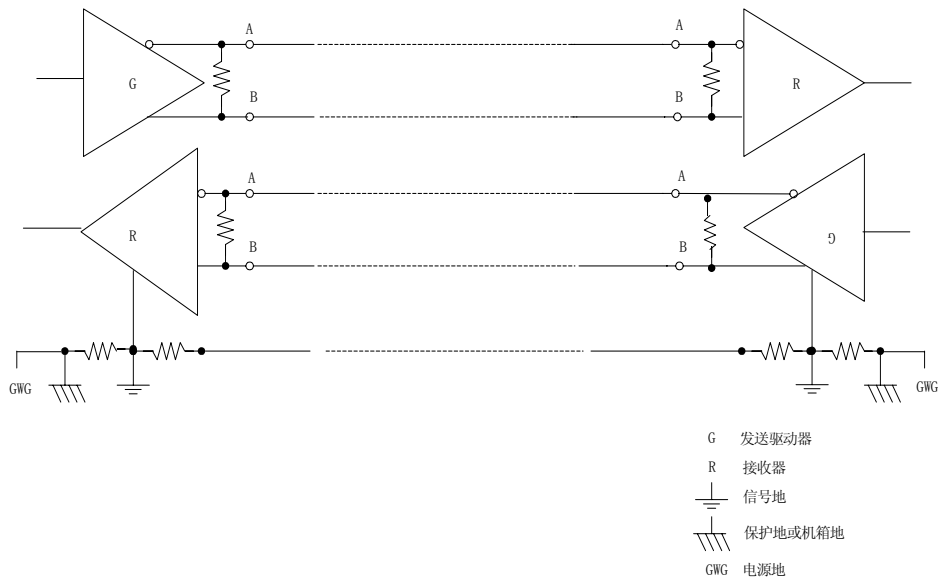

RS-422 interfaces support a maximum transmission distance of 4000 feet (about 1219 meters) and a maximum transmission rate of 10 Mb/s. Where, the length of the balanced twisted pair is in inverse proportion to the transmission rate, and the maximum transmission distance can be achieved only at the rate of 100 Kb/s. The maximum transmission rate can be achieved only within a very short distance. In general, a twisted pair as long as 100 meters can have a maximum transmission rate of 1 Mb/s. RS-422 needs a terminating resistor, while its resistance is equal to the characteristic impedance of the transmission cable. The terminating resistor is not required for short-distance transmission within 300 meters. The terminating resistor is connected to the farthest end of the transmission cable.

The pinout of the eView MT5000/4000 RS-485 (4-wire) is shown as follows:

Pin No.	Pin Name	Description
1	RX-	Data receiving signal cable A
6	RX+	Data receiving signal cable B
4	TX-	Data transmission signal cable A
9	TX+	Data transmission signal cable B
5	GND	Grounding signal cable

13.4 RS-485

Since RS-485 is developed on the basis of RS-422, many electrical specifications of the RS-485 are similar to those of the Rs-422. Both of them adopt balanced transmission mode and the transmission cables have to be configured with terminating resistors. RS-485 supports 2-wire and 4-wire modes. The 2-wire mode supports real multipoint bidirectional communication, where the "Enable" signal controls the transmission and receiving of data, as shown in the figure below:

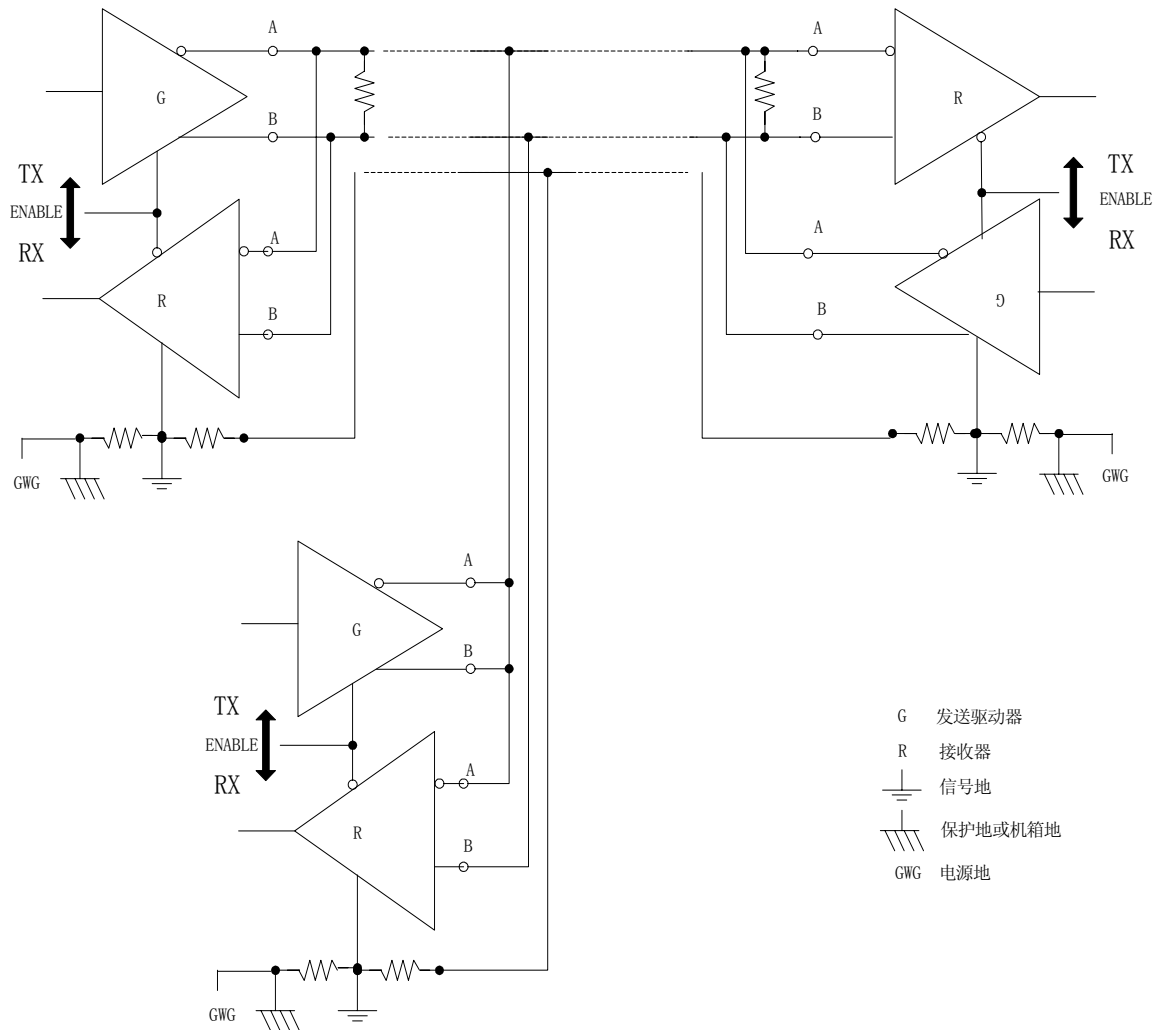

Electrical characteristics of the RS-485 are as follows: Logic "1" is indicated by the voltage difference of + (2~6)V between two cables; logic "0" is indicated by the voltage difference of - (2~6)V between two cables. RS-485 supports a maximum transmission rate of 10 Mbps. RS-485 interface adopts a combination of balanced drivers and differential receivers to enhance its capability of preventing common-mode interference, featuring better noise suppression and anti-interference performance. The standard maximum transmission distance is 4000 feet, but it can achieve an actual distance of 3000 meters. In addition, the bus of the RS-232 interface can be connected with only one receiver, that is, the single station capability. However, the bus of the RS-485 can be connected with a maximum of 128 receivers, that is, the multi-station capability. Therefore, the user can set up an equipment network with a single RS-485 interface. Since the RS-485 interface has excellent noise suppression and anti-interference performance, long transmission distance, and multi-station capability, it is widely applied. Because the half-duplex network established through the RS-485 interface needs two connection cables, the RS-485 interface adopt shielded twisted pairs for transmission cables.

Pinout of the eView MT5000/4000 RS-485 (2-wire) is shown as follows:

Pin No.	Pin Name	Description
1	RX-	Data receiving/transmission signal cable A
6	RX+	Data receiving/transmission signal cable B
5	GND	Grounding signal cable

Chapter 14 Connection of eView MT5000/4000 with Common PLCs

14.1 OMRON PLC



Connection of OMRON C Series PLC with MT5000/4000 Touch Screen

- EV5000 software setting:

Item	Recommended Setting	Optional Setting	Precaution
PLC Type	OMRON CPM2AH	OMRON	
COM	COM0/COM1	RS232/RS485	
Data Bits	7	7 or 8	Must be the same as the COM port settings of the PLC
Stop Bits	2	1 or 2	Must be the same as the COM port settings of the PLC
Bits per Second	9600	9600/19200/38400/57600/115200	Must be the same as the COM port settings of the PLC
Parity	Even parity	Even parity/odd parity/none	Must be the same as the COM port settings of the PLC
PLC Station No.	0	0-255	Must be the same as the COM port settings of the PLC

- ◆ PLC software setting:

Set the communication protocol of the COM port to Hostlink.

Please refer to related PLC programming software user manual of OMRON

Reference website: [HTTP://oeiweb.omron.com/oei/TechManuals-PLC.htm](http://oeiweb.omron.com/oei/TechManuals-PLC.htm)

- Operable address range:

PLC Address Type	Operable Range	Format	Description
IR	0-65535	DDD(BB)	I/O and internal relay
HR	0-65535	DDD(BB)	Holding relay
AR	0-65535	DDD(BB)	Auxiliary relay
LR	0-65535	DDD(BB)	Link relay
TC	0-255	DDD	Timer/counter register
DM	0-9999	DDD	Data register

Note: D indicates decimal notation, B indicates bit code, and the value range is 0 ~15.

The operable range in the above table indicates the operable range of the MT5000/4000 touch screen. The actual range of the PLC may be broader or narrower than this range.

The operable range in the above table indicates the operable range of the MT5000/4000 touch screen. The actual range of the PLC may be broader or narrower than this range.

- Detailed wiring diagram:

Note: The CPU of CPM1/CPM1A series does not provide standard serial ports and has to be configured with OMRON CPM1-CIF01 (RS232) communication adapters or OMRON CPM1-CIF11 (RS422) communication adapters to establish the link with the touch screen through the Host-Link. The CPU of CPM2A PLC provides RS-232 interface and it can be connected with the touch screen directly; it can also be configured with CPM1-CIF01 (RS232) communication adapters or OMRON CPM1-CIF11 (RS422) communication adapters to establish a link. For hardware descriptions, refer to manuals provided by OMRON.

1. CPU

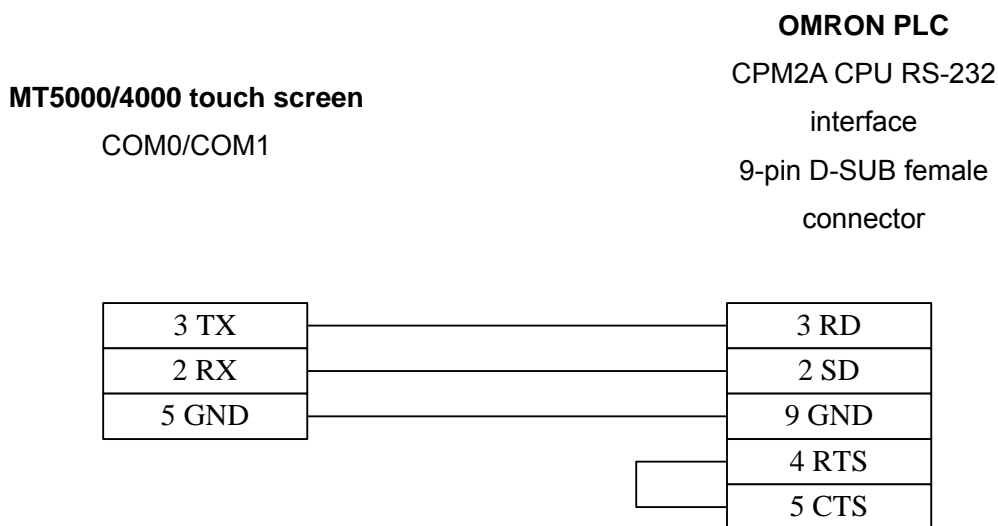

2. Communication module CPM1-CIF01

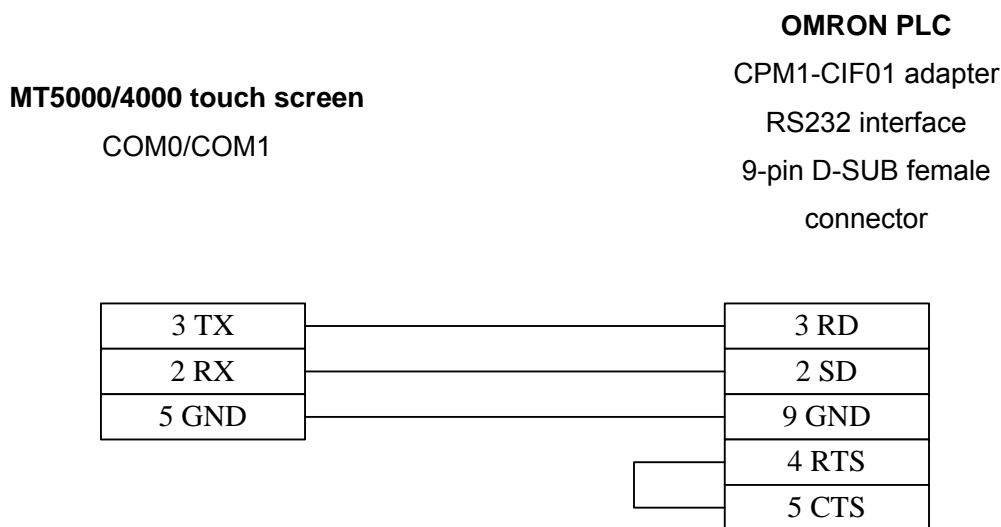

Note: Set the mode setting switch of the CPM1-CIF01 adapters to the Host Link communication mode.

3. Communication module CPM1-CIF11

MT5000/4000 touch screen
COM0/COM1

OMRON PLC
CPM1-CIF11 adapter
RS422 interface
5-pin terminal block



Connection of OMRON CQM Series PLC with eView MT5000/4000 Touch Screen

- EV5000 software setting:

Item	Recommended Setting	Optional Setting	Precaution
PLC Type	OMRON	OMRON	
COM	COM0/COM1	RS232/RS485	
Data Bits	7	7 or 8	Must be the same as the COM port settings of the PLC
Stop Bits	2	1 or 2	Must be the same as the COM port settings of the PLC
Bits per Second	9600	9600/19200/38400/ 57600/115200	Must be the same as the COM port settings of the PLC
Parity	Even parity	Even parity/odd parity/none	Must be the same as the COM port settings of the PLC
PLC Station No.	0	0-255	Must be the same as the COM port settings of the PLC

◆ PLC software setting:

Set the communication protocol of the COM port to Hostlink.

Refer to related PLC programming software user manual of OMRON.

Reference website: [HTTP://oeiweb.omron.com/oei/TechManuals-PLC.htm](http://oeiweb.omron.com/oei/TechManuals-PLC.htm)

● Operable address range:

PLC Address Type	Operable Range	Format	Description
IR	0-65535	DDD(BB)	I/O and internal relay
HR	0-65535	DDD(BB)	Holding relay
AR	0-65535	DDD(BB)	Auxiliary relay
LR	0-65535	DDD(BB)	Link relay
TC	0-255	DDD	Timer/counter register
DM	0-9999	DDD	Data register

Note: D indicates decimal notation, B indicates bit code, and the value range is 0 ~15.

The operable range in the above table indicates the operable range of the MT5000/4000 touch screen. The actual range of the PLC may be broader or narrower than this range.

● Detailed wiring diagram:

Note: OMRON CQM series of PLCs covers CQM1 and CPM1H series. Where, CQM1-CPU11 and CQM1H-CPU11 do not provide standard serial ports and have to be configured with OMRON CPM1-CIF01 (RS232) communication adapters or OMRON CPM1-CIF11 (RS422) communication adapters to establish the link with the touch screen through the Host-Link. Other CPUs of CQM series provide RS-232 interface and it can be connected with the touch screen directly; they can also be configured with CPM1-CIF01 (RS232) communication adapters or OMRON CPM1-CIF11 (RS422) communication adapters to establish a link. Where, CPU51/61 of the CQM1H series support serial communication module CQM1H-SCB41. For hardware descriptions, refer to manuals provided by OMRON.

1. CPU

<p>eView MT5000/4000 touch screen COM0/COM1</p>	<p>OMRON PLC CQM1/1H CPU RS-232 interface 9-pin D-SUB female connector</p>
--	---

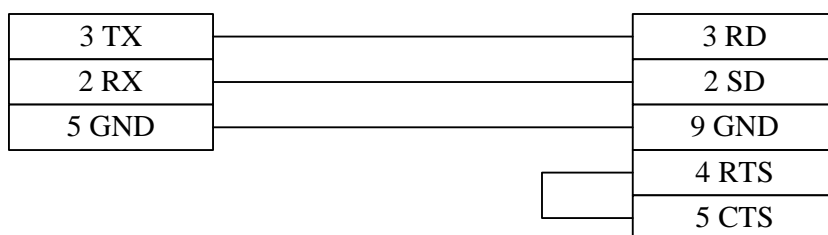

Note: The following CPUs can be connected with the touch screen directly: CQM1-CPU21/41/42/43/44 and CQM1H-CPU21/51/61. For hardware settings, refer to the technical manuals provided by OMRON.

2. Communication module CPM1-CIF01

<p>eView MT5000/4000 touch screen COM0/COM1</p>	<p>OMRON PLC CPM1-CIF01 adapter RS-232 interface 9-pin D-SUB female connector</p>
--	--

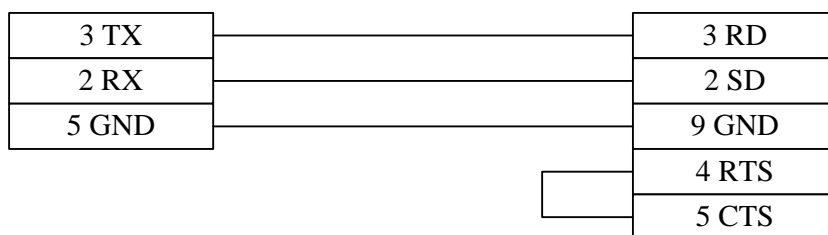

Note: Set the mode setting switch of the CPM1-CIF01 adapters to the Host Link communication mode.

3. Communication module CPM1-CIF11

eView MT5000/4000
touch screen
COM0/COM1

OMRON PLC
CPM1-CIF11 adapter
RS-422 interface
5-pin terminal block



4. Communication module CPM1H-SCB41

eView MT5000/4000 touch
screen
COM0/COM1

OMRON PLC
CPM1H-SCB41 communication
module
RS-232 interface
9-pin D-SUB female connector

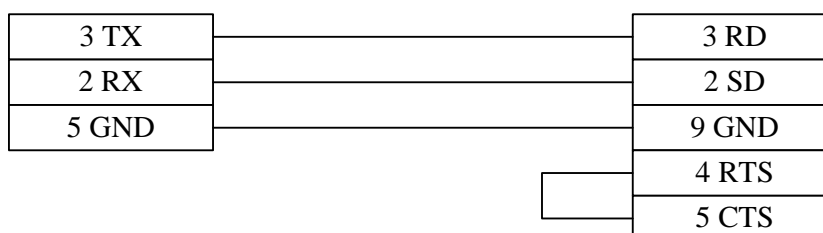

eView MT5000/4000 touch
screen
COM0/COM1

OMRON PLC
CPM1H-SCB41 communication
module
RS-422 interface
9-pin D-SUB female connector



Note: Only CQM1H-CPU51/61 support SCB41 communication module. For hardware settings, refer to the technical manuals provided by OMRON.

Connection of OMRON C200H/HS/ALPHA Series PLC with eView MT5000/4000 Touch Screen

- EV5000 software setting:

Item	Recommen	Optional Setting	Precaution
PLC Type	OMRON	OMRON	
COM	COM0/COM 1	RS232/RS485	
Data Bits	7	7 or 8	Must be the same as the COM port settings of the PLC
Stop Bits	2	1 or 2	Must be the same as the COM port settings of the PLC
Bits per Second	9600	9600/19200/38400/ 57600/115200	Must be the same as the COM port settings of the PLC
Parity	Even parity	Even parity/odd parity/none	Must be the same as the COM port settings of the PLC
PLC Station No.	0	0-255	Must be the same as the COM port settings of the PLC

- ◆ PLC software setting:

Set the communication protocol of the COM port to Hostlink.

Refer to related PLC programming software user manual of OMRON.

Reference website: [HTTP://oeiweb.omron.com/oei/TechManuals-PLC.htm](http://oeiweb.omron.com/oei/TechManuals-PLC.htm)

- Operable address range:

PLC Address	PLC Address	Operable Range	Format
IR	0-65535	DDD(BB)	I/O and internal
HR	0-65535	DDD(BB)	Holding relay
AR	0-65535	DDD(BB)	Auxiliary relay
LR	0-65535	DDD(BB)	Link relay
TC	0-255	DDD	Timer/counter
DM	0-9999	DDD	Data register

Note: D indicates decimal notation, B indicates bit code, and the value range is 0 ~15.

The operable range in the above table indicates the operable range of the MT5000/4000 touch

screen. The actual range of the PLC may be broader or narrower than this range.

- Detailed wiring diagram:

Note: OMRON C200H series PLCs include C200H, C200HS and ALPHA series. Where, ALPHA series consist of such models as C200HX/HG/HE. C200H series PLCs can be connected with the touch screen through the HOSTLink protocol with the RS-232 interface on the CPU. They can also be configured with various compatible HOSTLink communication modules provided by OMRON to connect with the touch screen. Please pay attention to software and hardware settings. For hardware description, refer to manuals provided by OMRON.

1. CPU (C200H/HS/ALPHA series PLC)

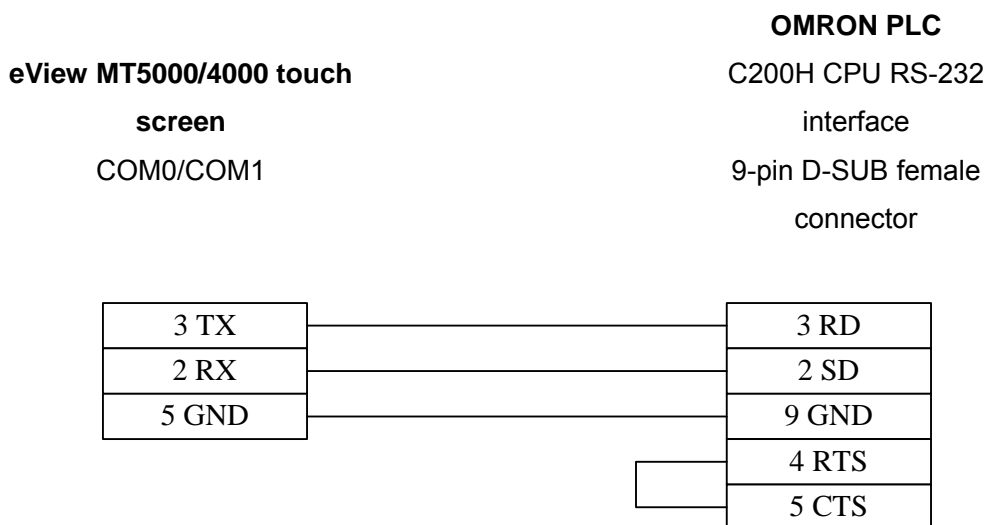

Note: The wiring method of SRM1 series PLCs is the same as that shown in the above figure. In the CPUs of the C200H series PLCs, there are Dial in-line Package (DIP) switches for parameter setting. Please pay attention to parameter settings. For detailed hardware settings, refer to the technical manuals provided by OMRON.

2. Communication module (C200H-LK201, 3G2A6-LK201 communication module RS232)

<p>eView MT5000/4000 touch screen COM0/COM1</p>	<p>OMRON PLC LK201 adapter RS-232 interface 25-pin D-SUB female connector</p>
--	--

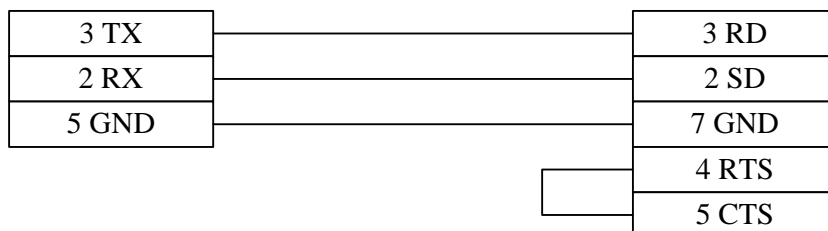

Note: Please pay attention to the setting of four DIP switches on the module. For indications of these DIP switches, refer to the technical manual of communication modules of OMRON. The wiring method of the CPUs of the C series PLCs developed at an earlier stage, like C20H/C28H/C40H CPU, is the same as that shown in the above figure.

3. Communication module (C200H-LK202, 3G2A6-LK202 communication module RS422)

<p>eView MT5000/4000 touch screen COM0/COM1</p>	<p>OMRON PLC LK202 adapter RS-422 interface 9-pin D-SUB female connector</p>
--	---

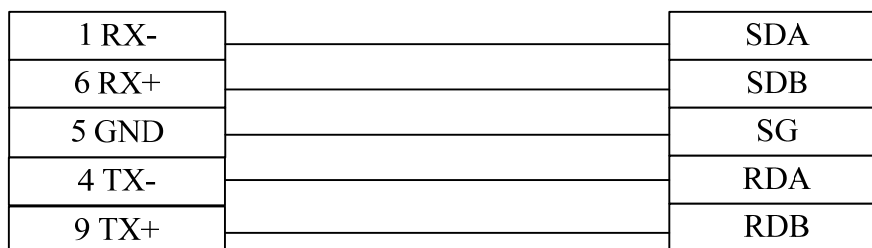

4. Communication module (C200HW-COM02/03/04/05/06 communication module RS 232)

<p>eView MT5000/4000 touch screen COM0/COM1</p>	<p>OMRON PLC C200HW-COM communication module RS-232 interface 9-pin D-SUB female connector</p>
--	--

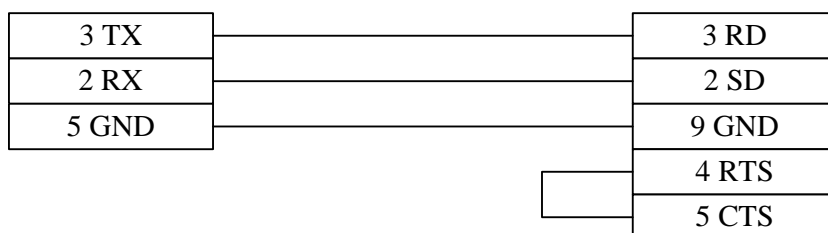

5. Communication module (C200HW-COM03/06 communication module RS 422)

<p>eView MT5000/4000 touch screen COM0/COM1</p>	<p>OMRON PLC C200HW-COM communication module RS-422 interface 9-pin D-SUB female connector</p>
--	--

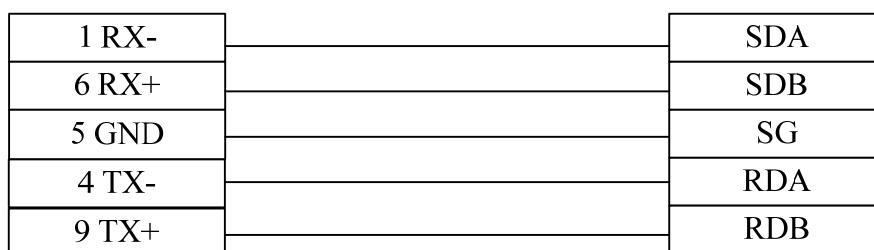

Note: C200HW-COM communication module supports only the C200H ALPHA series of CPUs. Pay attention to the settings of DIP switches. For hardware settings, refer to the technical manuals provided by OMRON.

- Operable address range of CJ series of PLCs:

PLC Address	Operable	Format	Description
CIO	0-65535	DDD	Internal relay
H	0-65535	DDD	Holding relay
A	0-959	DDD	Auxiliary relay

T	0-4095	DDD	Timer node
C	0-4095	DDD	Counter node
W	0-511	DDD	Workspace register
D	0-32767	DDD	Data register
EM	0-C	DDD	Extended data

14.2 Mitsubishi PLC



Connection of MITSUBISHI FX Series PLC with eView MT5000/4000 Touch Screen

- EV5000 software setting:

Item	Recommended Setting	Optional Setting	Precaution
PLC Type	MITSUBISHI FX2n	MITSUBISHI FX2n	Select corresponding PLC type according to different PLCs
COM	COM0/COM1	RS232/RS485	
Data Bits	7	7 or 8	Must be the same as the COM port settings of the PLC
Stop Bits	1	1 or 2	Must be the same as the COM port settings of the PLC
Bits per Second	9600	9600/19200/38400/57600/115200	Must be the same as the COM port settings of the PLC
Parity	Even parity	Even parity/odd parity/none	Must be the same as the COM port settings of the PLC
PLC Station No.	0	0-255	Must be the same as the COM port settings of the PLC

Note: MITSUBISHI FX2n is applicable only to FX2n series of PLCs, and MITSUBISHI FX0n/FX2 is applicable to such models as FX0n/ FX1N/FX2. MITSUBISHI FX0n/FX2/FX2n COM is applicable only to the circumstance where the connection is made through the extended communication BD. It supports PLC station No. only when the connection is made through the communication module. It is not required to set the PLC station No. in other circumstances.

- PLC software setting:

Please refer to related PLC programming software user manual of MITSUBISHI.

Reference website: [HTTP://www.mitsubishi-automation.com](http://www.mitsubishi-automation.com)

◆ Operable address range:

PLC Address	Operable Range	Format	Description
X	0-377	OOO	External input node
Y	0-377	OOO	External output node
M	0-7999	DDD	Internal auxiliary node
SM	8000-9999	DDD	Special auxiliary node
T_bit	0-255	DDD	Timer node
C_bit	0-255	DDD	Counter node
T_word	0-255	DDD	Timer buffer
C_word	0-255	DDD	Counter buffer
C_dword	200-255	DDD	Counter buffer (double)
D	0-7999	DDD	Data register
SD	8000–9999	DDD	Special data register

Note: D indicates decimal notation, O indicates octal notation, and the value range is 0 ~7.

The operable range in the above table indicates the operable range of the MT5000/4000 touch screen. The actual range of the PLC may be broader or narrower than this range.

● Detailed wiring diagram:

Note: MITSUBISHI FX series PLCs include such models as FX0/FX0s/FX0n/FX1s/FX1n/FX2nc/FX2n. All of them can be connected with the eView touch screen either through the programming COM port in the CPU or through the communication interface board 232BD or 485BD. When BD module is used, select such PLC types as MITSUBISHI FX0n/FX2/FX2n COM and pay attention to the settings of the communication format register D8120. Set the b9 and b8 of BFM#0 to 0. For detailed hardware description, refer to the technical manuals provided by MITSUBISHI.

1. CPU

eView MT5000/4000 touch screen
COM0/COM1

MITSUBISHI PLC
FX series CPU RS-422 interface
8-pin DIN round female connector

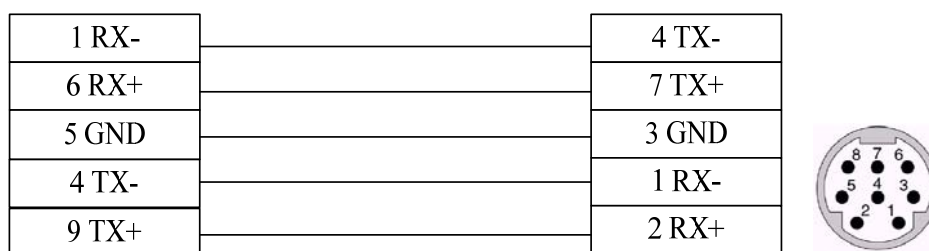

Pin assignment of 8-pin DIN round female connector

2. Communication module RS232BD

eView MT5000/4000 touch screen
COM0/COM1

MITSUBISHI PLC
FX series RS-232 BD module
RS-232 interface
9-pin D-SUB female connector

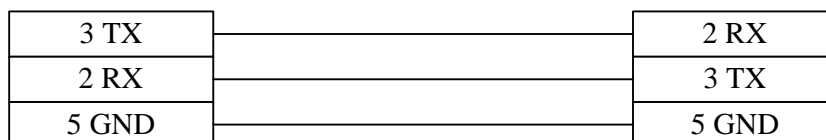

3. Communication module RS485BD

eView MT5000/4000
touch screen
COM0/COM1

MITSUBISHI PLC
FX series RS-485 BD
module
RS-422 interface
5-pin terminal block

1 RX-		SDB
6 RX+		SDA
5 GND		SG
4 TX-		RDB
9 TX+		RDA

Connection of Mitsubishi FX3U Series PLC with MT5000/4000 Touch Screen

◆EV5000 software setting:

Item	Recommended Setting	Optional Setting	Precaution
PLC Type	Mitsubishi FX3U		
COM	RS-232	RS232	
Data Bits	7	7 or 8	Must be the same as the COM port settings of the controller
Stop Bits	1	1 or 2	Must be the same as the COM port settings of the controller
Bits per Second	9600	9600/19200/38400/ 57600/115200	Must be the same as the COM port settings of the controller
Parity	Even parity	Even parity/odd parity/none	Must be the same as the COM port settings of the controller
PLC Station No.	0		Must be the same as the COM port settings of the controller

◆ Operable address range:

Bit/Word	PLC Address Type	Operable Range	Format	Description
bit	T	0 - 511	DDD	
bit	C	0 - 199	DDD	
bit	M	0 - 7999	DDDD	
bit	D_bit	0.0 - 7999.F	DDDDH	
Bit	X	0 - 377	OOO	
bit	Y	0 - 377	OOO	
bit	S	0 - 4095	DDDD	
bit	SM	8000-9999	DDDD	Corresponding PLC software does not contain this register
word	R_word	0 - 32767	DDDDD	
Word	D_word	0 - 7999	DDDD	
Word	C_word	0 - 199	DDD	
Word	T_word	0 - 511	DDD	
word	SD_word	8000-9999	DDDD	Corresponding PLC software does not contain this register
Dword	C_dword	200 - 255	DDD	

- Detailed wiring diagram:

1. CPU

<p>eView MT5000/4000 touch screen COM0/COM1</p>	<p>MITSUBISHI PLC FX series CPU RS-422 interface 8-pin DIN round female connector</p>
--	--

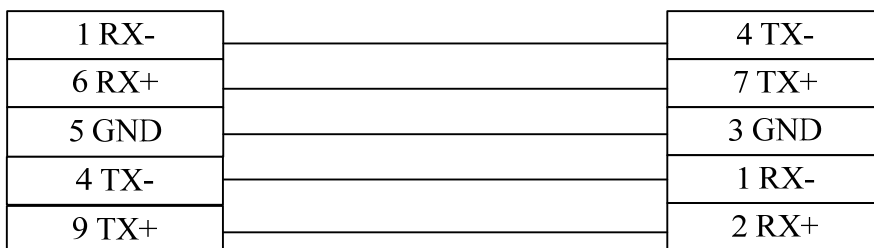

Pin assignment of 8-pin DIN round female connector

2. Communication module RS232BD

<p>eView MT5000/4000 touch screen COM0/COM1</p>	<p>MITSUBISHI PLC FX series RS232BD module RS-232 interface 9-pin D-SUB female connector</p>
--	---

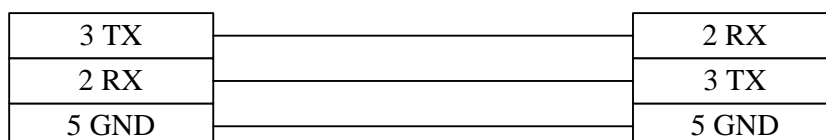

3. Communication module RS485BD

eView MT5000/4000
touch screen
COM0/COM1

MITSUBISHI PLC
FX series RS485BD
module
RS-422 interface
5-pin terminal block

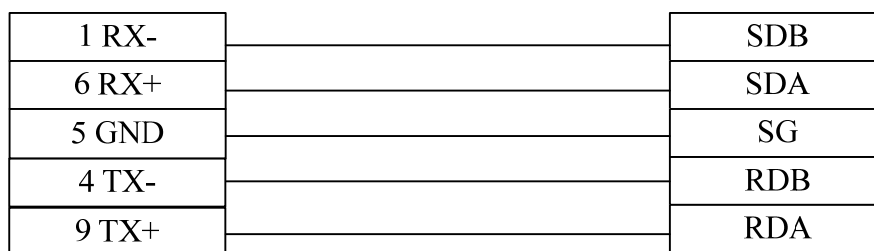

Connection of MITSUBISHI Q Series PLC with eView MT5000/4000 Touch Screen

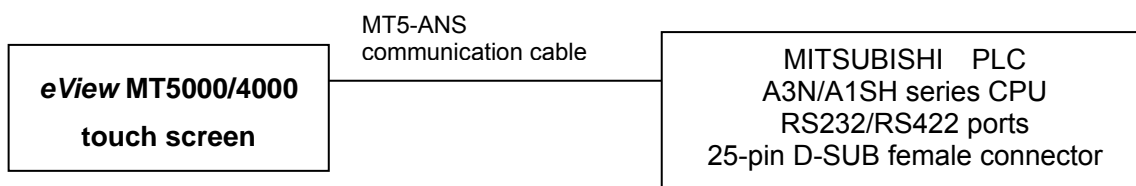

- EV5000 software setting:

Item	Recommended Setting	Optional Setting	Precaution
PLC Type	MITSUBISHI Melsec Q	MITSUBISHI Melsec Q	Select corresponding PLC type according to different PLCs
COM	COM0/COM1	RS232/RS485	
Data Bits	8	7 or 8	Must be the same as the COM port settings of the PLC
Stop Bits	1	1 or 2	Must be the same as the COM port settings of the PLC
Bits per Second	9600	9600/19200/38400/ 57600/115200	Must be the same as the COM port settings of the PLC

Parity	Odd parity	Even parity/odd parity/none	Must be the same as the COM port settings of the PLC
PLC Station No.	0	0-255	Must be the same as the COM port settings of the PLC

◆ PLC software setting:

Please refer to related PLC programming software user manual of MITSUBISHI. ,

Reference website: [HTTP://www.mitsubishi-automation.com](http://www.mitsubishi-automation.com)

◆ Operable address range:

PLC Address Type	Operable Range	Format	Description
DX	0-77F	hhh	External input node
DY	0-77F	hhh	External output node
M	0-8191	dddd	Internal input auxiliary node
L	0-2047	dddd	Lock relay
F	0-1023	dddd	Alarm
V	0-1023	dddd	Marginal relay
B	0-7FF	hhh	Link relay
TC	0-511	ddd	Timer coil
SS	0-511	ddd	Holding timer node
SC	0-511	ddd	Holding timer coil
CS	0-511	ddd	Counter node
CC	0-511	ddd	Counter coil
SB	0-3FF	hhh	Special link relay
S	0-2047	dddd	Single-step relay
DX	0-7FF	hhh	Direct access input
DY	00-7FF	hhh	Direct access output
TS	0-511	ddd	Timer node
W	0-7FF	hhh	Link register
TN	0-511	ddd	Current value of timer
SN	0-511	ddd	Current value of holding

			timer
CN	0-511	ddd	Current value of counter
R	0-32767	dddddd	File register
SW	0-3FF	hhh	Special register
Z	0-3FF	d	Index register
ZR	0-3FF	hhhh	File register
D	0-3FF	dddddd	Data register

Note: D indicates decimal notation, O indicates octal notation, and the value range is 0 ~7. The operable range in the above table indicates the operable range of the MT5000/4000 touch screen. The actual range of the PLC may be broader or narrower than this range.

- Detailed wiring diagram:

1. CPU

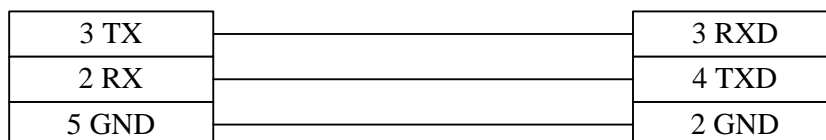

2. Communication module



eView MT5000/4000
touch screen
COM0/COM1

MITSUBISHI PLC
Q series QJ71C24
RS232 interface
9-pin D-SUB male
connector

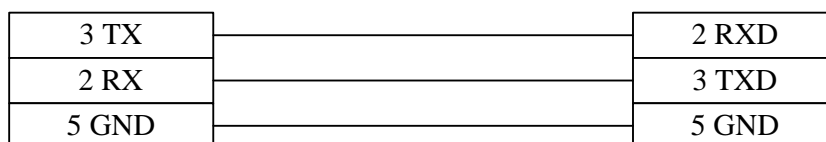

14.3 KOYO PLC



Koyo Electronics

Connection of KOYO Direct Logic Series PLC with eView MT5000/4000 Touch Screen

- EV5000 software setting:

Item	Recommended Setting	Optional Setting	Precaution
PLC Type	KOYO DIRECT		
COM	COM0/COM1	RS232/RS485	Set it according to the type of COM port actually in use
Data Bits	8	7 or 8	* Data bits for this protocol are set to 8 in a fixed manner
Stop Bits	1	1 or 2	Must be the same as the COM port settings of the PLC
Bits per Second	9600	9600/19200/38400/ 57600/115200	Must be the same as the COM port settings of the PLC
Parity	Odd parity	Even parity/odd parity/none	Must be the same as the COM port settings of the PLC
PLC Station No.	1	1-90 *	Set this parameter according to the recommended settings

- PLC software setting:

1. The security password function must be disabled.
2. The COM port must adopt K sequence protocol.
3. Set the switch of the CPU with working mode setting switch to the TERM state.

For other settings, refer to related PLC programming software user manual provided by Koyo Electronics.

Reference website: [Http://www.automationdirect.com](http://www.automationdirect.com)

- Operable address range:

PLC Address Type	Operable Range	Format	Description
X	0-32767	OOO	External input node
Y	0-32767	OOO	External output node
C	0-32767	OOO	Internal auxiliary node
T	0-32767	OOO	Timer node
CT	0-32767	OOO	Counter node
V	0-32767	OOOO	Data register

Note: "O" indicates octal notation.

Presently, EV5000 does not support some PLC address types. They can be translated into the addresses actually supported.

The operable range in the above table indicates the operable range of the MT5000/4000 touch screen. The actual range of the PLC may be broader or narrower than this range.

- Detailed wiring diagram:

Note: KOYO Direct Logic series PLCs cover DL05, DL105, DL205, DL305 and DL405 series. The CPUs of all these series can be connected with the eView MT5000/4000 touch screen through the K sequence serial communication protocol and by the RS-232/RS-422 interface on the CPUs.

Where, DL240/DL250 and DL405 series of PLCs can be connected with the touch screen through data communication modules. For related software and hardware settings, refer to the technical manuals provided by Koyo Electronics.

1. CPU (DL05/DL105/DL230/DL240/DL250/DL350/DL450 RS232 Port)

<p>eView MT5000/4000 touch screen COM0/COM1</p>	<p>KOYO PLC Direct Logic series RS-232 interface 6-pin RJ-11 female connector</p>
--	--

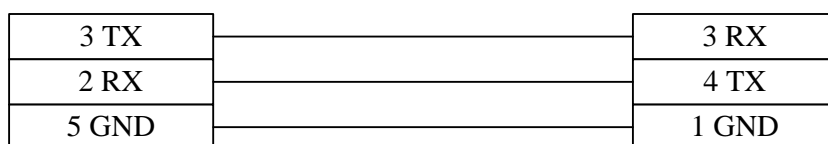

Note: Port1 & Port2 of the DL05 series, Port1 & Port2 of the DL240 series, Port1 of the DL250 series, Port1 of the DL350 series, and Port2 of the DL450 series are all RJ-12 hardware interfaces. The wiring method for them is the same as that shown in the above figure. Please note that the address of some ports is 1 invariably, but the address of some other ports has to be set. Make sure the communication protocol of the port is set to K sequence.

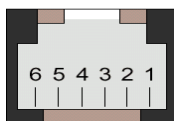

Pin assignment of RJ-11 6-pin Female Connector

2. CPU (DL250 CPU Port2 RS232)

<p>eView MT5000/4000 touch screen COM0/COM1</p>	<p>KOYO PLC DL250 CPU RS-232 port2 15-pin SVGA female connector</p>
--	--

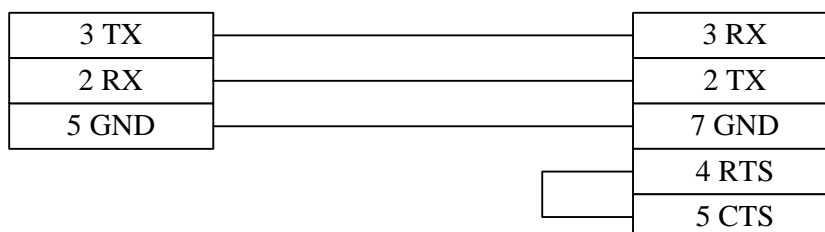

Note: Port2 of the DL250 CPU combines RS-232 electrical interface and RS-422 electrical interface. Please pay attention to the setting of the type during use.

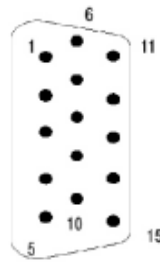

Pin Array of 15-pin SVGA D-SUB Female Connector

3. CPU (DL250 CPU Port2 RS422)

eView MT5000/4000 touch
screen
COM0/COM1

KOYO PLC
DL250 CPU
RS-422 port2
15-pin SVGA female
connector

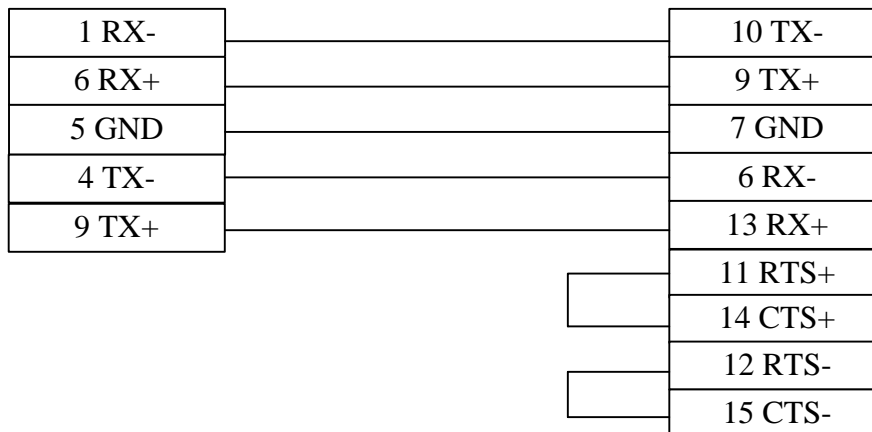

Note: Port2 of the DL250 CPU combines RS-232 electrical interface and RS-422 electrical interface. Please pay attention to the setting of the type during use.

4. CPU (DL430/DL440/DL450 CPU Port0 RS232)

**eView MT5000/4000 touch
screen**
COM0/COM1

KOYO PLC
DL405 series CPU
RS-232 interface0
15-pin D-SUB female connector

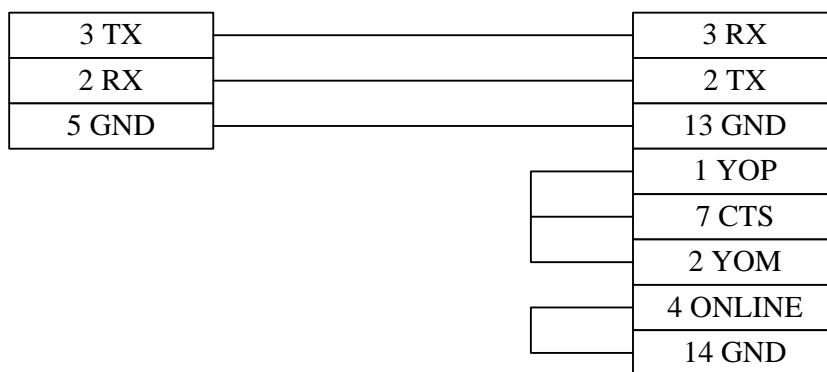

5. CPU (DL430/DL440/DL450 CPU Port1 & DL350 CPU Port2 RS232)

**eView MT5000/4000 touch
screen**
COM0/COM1

KOYO PLC
DL305/405 series CPU
RS-232 interface
25-pin D-SUB female connector

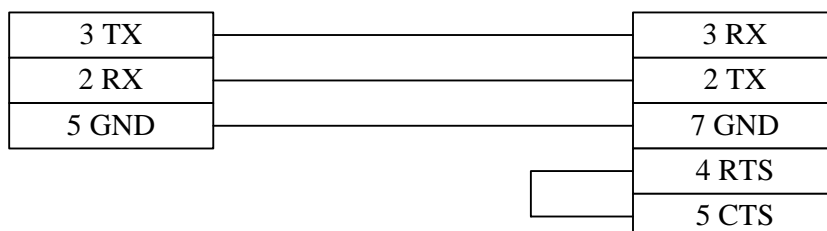

6. CPU (DL430/DL440/DL450 CPU Port1 & DL350 CPU Port2 RS422)

**eView MT5000/4000 touch
screen
COM0/COM1**

KOYO PLC
DL305/DL405 series CPU unit
RS-422 interface
25-pin D-SUB female connector

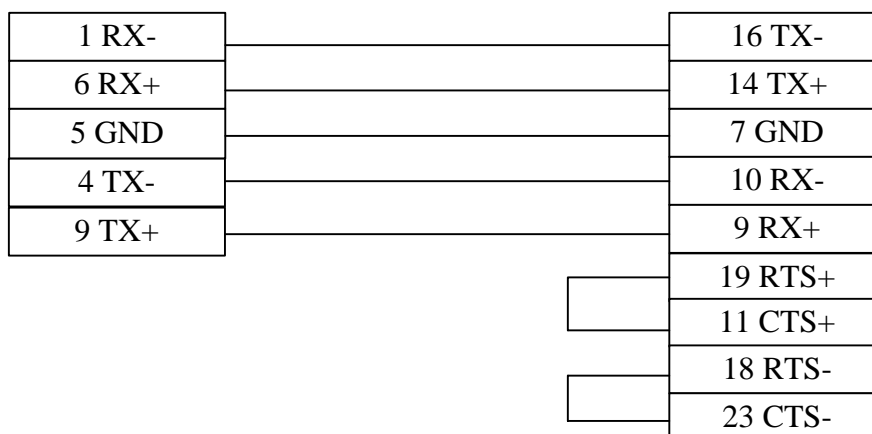

7. CPU (DL450 CPU Port3 RS422)

**eView MT5000/4000 touch
screen
COM0/COM1**

KOYO PLC
DL405 series CPU unit
RS-422 interface3
25-pin D-SUB female
connector



8. Data communication unit (D2-DCM module of DL205 series, D4-DCM module of DL405 series, RS232)

eView MT5000/4000 touch screen
COM0/COM1

KOYO PLC
DL205/405 series DCM unit
RS-232 interface
25-pin D-SUB female connector

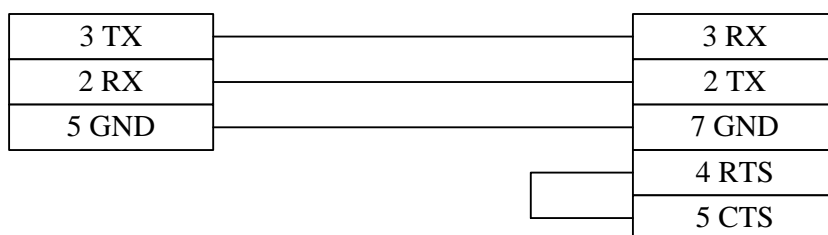

Note: Among all PLCs in the DL205 series, only DL240/DL250 CPU supports D2-DCM unit. All PLCs of the DL405 series support D4-DCM unit. Please pay attention to the settings of the DIP switch. It must be set to the DirectNET Slave mode. In addition, pay attention to the setting of the communication address. For details, refer to hardware manuals provided by Koyo Electronics.

9. Data communication unit (D2-DCM module of DL205 series, D4-DCM module of DL405 series, RS422)

eView MT5000/4000 touch screen
COM0/COM1

KOYO PLC
DL205/DL405 series DCM unit
RS-422 interface
25-pin D-SUB female connector

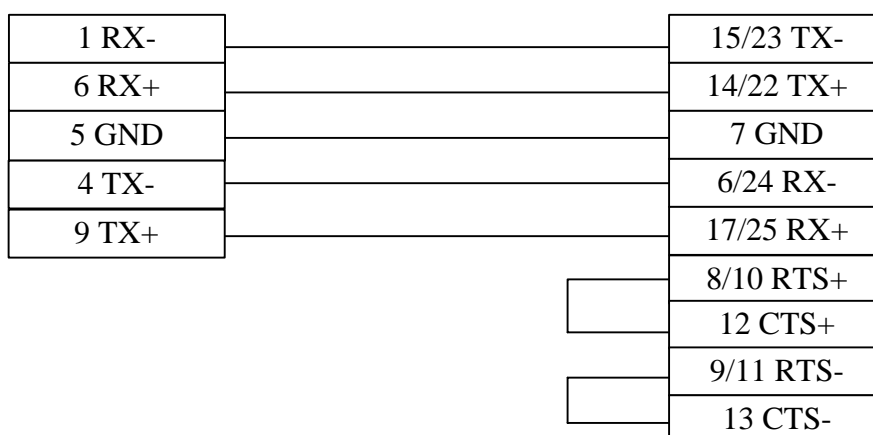

Note: Among all PLCs in the DL205 series, only DL240/DL250 CPU supports D2-DCM unit. All PLCs of the DL405 series support D4-DCM unit. Please pay attention to the settings of the DIP switch. It must be set to the DirectNET Slave mode. In addition, pay attention to the setting of the

communication address. For details, refer to hardware manuals provided by Koyo Electronics.

14.4 Allen-Bradley PLC



Rockwell Automation

Connection of Allen-Bradley Micrologix Series PLC with eView MT5000/4000 Touch Screen

- EV5000 software setting:

Item	Recommended Setting	Optional Setting	Precaution
PLC Type	AB DF1		
COM	COM0/COM1	RS232/RS485	
Data Bits	8	7 or 8	Data bits for this protocol are set to 8 in a fixed manner
Stop Bits	1	1 or 2	Must be the same as the COM port settings of the PLC
Bits per Second	19200	9600/19200/38400/ 57600/115200	Must be the same as the COM port settings of the PLC
Parity	None	Even parity/odd parity/none	Must be the same as the COM port settings of the PLC
PLC Station No.	1	0-255	Adopt the recommended settings, without the need of manual settings by the user

Note: In communication parameter settings of Micrologix PLC, set DF1 to the full-duplex mode and set it to be free of hardware handshake signals.

- PLC software setting:

Please refer to related PLC programming software user manual of ROCKWELL.

Reference website: [HTTP://www.ab.com](http://www.ab.com)

- Operable address range:

PLC Address Type	Operable Range	Format	Description
I1	0-4096	DDD (DD)	External input node
O0	0-4096	DDD (DD)	External output node

B3/10/11/12/13	0-4096	DDD (DD)	Internal auxiliary node
T4SV	0-254	DDD	Set value register of timer
T4PV	0-254	DDD	Actual value register of timer
C5SV	0-254	DDD	Set value register of counter
C5PV	0-254	DDD	Actual value register of counter
F8	0-254	DDD	Floating data register (double word)
N7/10/11/12/13/14/15	0-254	DDD	Data register

Note:

- 1) D indicates decimal notation, and the DD after the bracket indicate the value range of 0 ~15. When the address is less than 10, add a 0 before the number. For example, write 8 as 08.
- 2) The operable range in the above table indicates the operable range of the MT5000/4000 touch screen. The actual range of the PLC may be broader or narrower than this range.

- Detailed wiring diagram:

Note: Allen-Bradley Micrologix series PLCs include three series of Micrologix1000, Micrologix1200 and Micrologix1500. All of them can be connected with the eView MT5000/4000 touch screen through the serial port on their respective CPUs and by the DF1 serial communication protocol. They can also be connected with the touch screen through the AIC+ communication module provided by Allen-Bradley. For related software and hardware settings, refer to the technical manuals provided by ROCKWELL.

1. CPUMicrologix1000/1200/1500

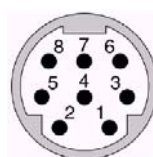
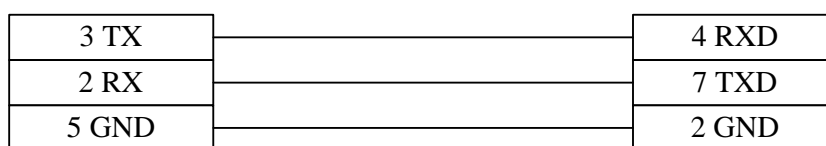

Mini Din 8 Pin Port

Pin assignment of 8-pin DIN round female connector

2. Communication module AIC+ (part No. 1761-NET-AIC) RS232

eView MT5000/4000 touch screen
COM0/COM1

Allen-Bradley PLC
Micrologix series AIC+ communication module
RS-232 interface
9-pin D-SUB female connector

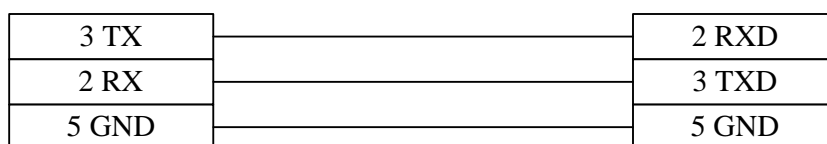

eView MT5000/4000 touch screen
COM0/COM1

Allen-Bradley PLC
Micrologix series AIC+ communication module
RS-232 interface
8-pin DIN round female connector

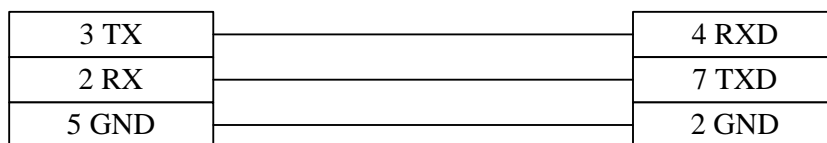

Connection of Allen-Bradley SLC500 Series PLC with eView MT5000/4000 Touch Screen

- EV5000 software setting:

Item	Recommended Setting	Optional Setting	Precaution
PLC Type	AB DF1	AB DF1/AB DH485	Select different protocols for different ports
COM	COM0/COM1	RS232/RS485	
Data Bits	8	7 or 8	Data bits for this protocol are set to 8 in a fixed manner
Stop Bits	1	1 or 2	Must be the same as the COM port settings of the PLC
Bits per Second	19200	9600/19200/38400/57600/115200	Must be the same as the COM port settings of the PLC
Parity	None	Even parity/odd parity/none	Must be the same as the COM port settings of the PLC

PLC Station No.	1	0-31	Adopt the recommended value for DF1 protocol
-----------------	---	------	--

Note: If the DF1 communication protocol is selected, the DF1 in the PLC communication parameters must be set to full-duplex mode, check mode set to CRC, and hardware handshaking disabled. It is not required to set PLC station No. If the DH485 communication protocol is selected, the PLC station No. must be set, and the human-machine station No. must be different from the PLC station No.

- PLC software setting:

Please refer to related PLC programming software user manual of ROCKWELL.

Reference website: [HTTP://www.AB.com](http://www.AB.com)

- Operable address range:

PLC Address Type	Operable	Format	Description
I1	0-4096	DDD(DD)	External input node
O0	0-4096	DDD(DD)	External output node
B3/10/11/12/13	0-4096	DDD(DD)	Internal auxiliary node
T4SV	0-254	DDD	Set value register of
T4PV	0-254	DDD	Actual value register of
C5SV	0-254	DDD	Set value register of
C5PV	0-254	DDD	Actual value register of
F8	0-254	DDD	Floating data register
N7/10/11/12/13/14/1	0-254	DDD	Data register

Note:

- 1) D indicates decimal notation, and the DD after the bracket indicate the value range of 0 ~15. When the address is less than 10, add a "0" before the number. For example, write 8 as 08.
- 2) The operable range in the above table indicates the operable range of the MT5000/4000 touch screen. The actual range of the PLC may be broader or narrower than this range.

- Detailed wiring diagram:

Note: Allen-Bradley SLC500 series PLCs includes SLC5/01, SLC5/02, SLC5/03, SLC5/04 and SLC5/05 series of CPUs. Where, SLC5/01 and SLC5/02 series do not provide RS-232 interface and cannot communication with the touch screen directly through the DF1 protocol. Instead, they have to be configured with communication module 1747-KE and connected with the touch screen through the DF1 interface on the module. SLC5/03, SLC5/04 and SLC5/05 can be connected with

the touch screen through the DF1 interface on the CPUs. In addition, all types of CPUs can be connected with the eView touch screen through the DH485 interface on the CPUs. For related software and hardware settings, refer to the technical manuals provided by ROCKWELL.

1. CPU (SLC5/03, SLC5/04, SLC5/05 CPU DF1 Port)

<p>eView MT5000/4000 touch screen COM0/COM1</p>	<p>Allen-Bradley PLC SLC500 series CPU RS-232 interface 9-pin D-SUB female connector</p>
--	---

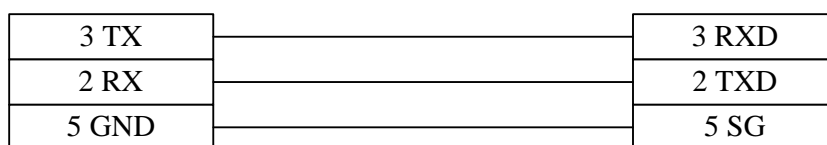

2. CPU (SLC5/01, SLC5/02, SLC5/03, SLC5/04, SLC5/05 CPU DH485 Port)

<p>eView MT5000/4000 touch screen COM0/COM1</p>	<p>Allen-Bradley PLC SLC500 series CPU DH485 interface RJ-45 female connector</p>
--	--

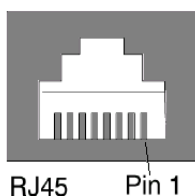
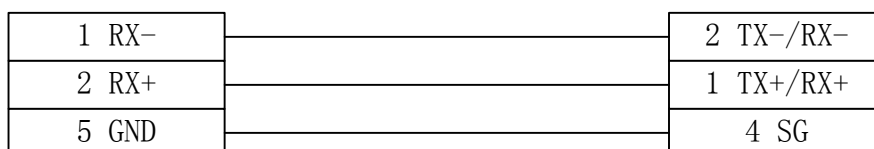

Pin assignment of 8-pin RJ-45 female connector

3. Communication module (1747-KE DF1 Port)

**eView MT5000/4000 touch
screen**
COM0/COM1

Allen-Bradley PLC
1747-KE module
DF1 RS-232 interface
9-pin D-SUB female
connector

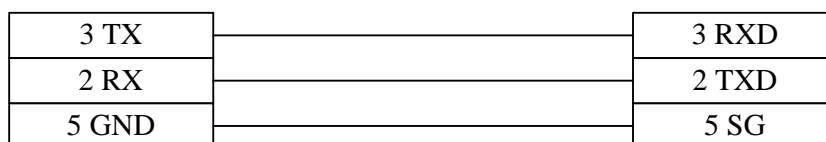

14.5 MODICON PLC



Schneider Electric

**Connection of MODICON Compact (A/E984)/Momentum/Quantum Series PLC with
MT5000/4000 Touch Screen**

- EV5000 software setting:

Item	Recommended Setting	Optional Setting	Precaution
PLC Type	Modbus RTU		
COM	COM0/COM1	RS232/RS485	
Data Bits	8	7 or 8	Data bits for this protocol are set to 8 in a fixed manner
Stop Bits	1	1 or 2	Must be the same as the COM port settings of the PLC
Bits per Second	9600	9600/19200/38400/ 57600/115200	Must be the same as the COM port settings of the PLC
Parity	Even parity	Even parity/odd parity/none	Must be the same as the COM port settings of the PLC

PLC Station No.	1	1-247*	Must be the same as the COM port settings of the PLC
-----------------	---	--------	--

Note: In fact, the maximum setting range of the DIP switch on the Quantum series of PLCs is 1-64.

- PLC software setting:

Set the communication protocol of the COM port to Modbus RTU mode.

Please refer to related PLC programming software user manual of Schneider Electric.

Reference website: [HTTP://www.modicon.com](http://www.modicon.com)

- Operable address range:

PLC Address Type	Operable Range	Format	Description
0x	1-9999	DDDD	System internal/external output node
1x	1-9999	DDDD	System internal/external input node
3x	1-9999	DDDD	Analog input data register
4x	1-9999	DDDD	Data register

Note:

- 1) D indicates decimal notation. If it is necessary to operate the double word variable, select 2 in the corresponding component address properties dialog box.
- 2) The operable range in the above table indicates the operable range of the MT5000/4000 touch screen. The actual range of the PLC may be broader or narrower than this range.

- Detailed wiring diagram:

Note: Modicon Compact/Momentum/Quantum series PLCs can be connected with the eView touch screen through the communication port on the CPUs and by the Modbus RTU protocol. Where, the 171 CCS 960 XX in the Compact (A/E 984) series does not support Modbus serial port and cannot communicate with the touch screen directly; instead, it can be connected with the touch screen through the communication module 171 JNN 210 32. For detailed settings, refer to the technical manuals provided by Schneider Electric.

1. CPU (Compact/Momentum series PLC RS232)

<p>eView MT5000/4000 touch screen COM0/COM1</p>	<p>Modicon PLC Compact/Momentum series CPU COM port 8-pin RJ-45 female connector</p>
--	---

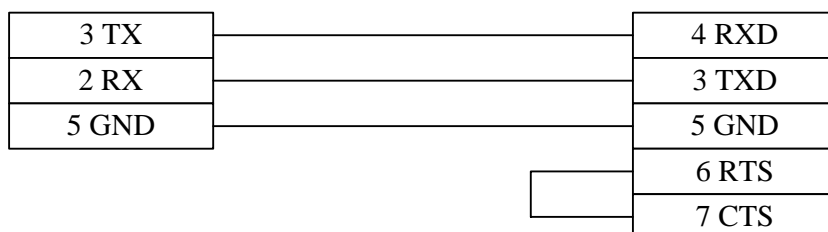

Note: Two Modbus serial ports of the CPU E984 – 258/265/275/285 in Compact series and the COM1 of the CPU 171 CCS 700/760/780 in the Momentum series are all RJ-45 hardware interfaces. The wiring diagram is shown in the above figure. For related software and hardware settings, refer to the technical manuals provided by Schneider Electric.

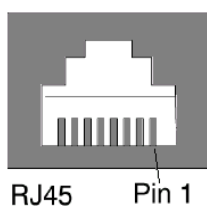

Pin assignment of 8-pin RJ-45 female connector

2. CPU (Momentum series PLC RS485)

<p>eView MT5000/4000 touch screen COM0/COM1</p>	<p>Modicon PLC Momentum series CPU COM port 8-pin RJ-45 female connector</p>
--	---

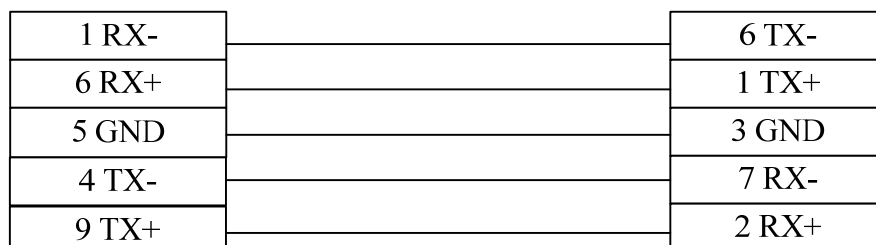

3. CPU (Compact / Quantum series PLC RS485)

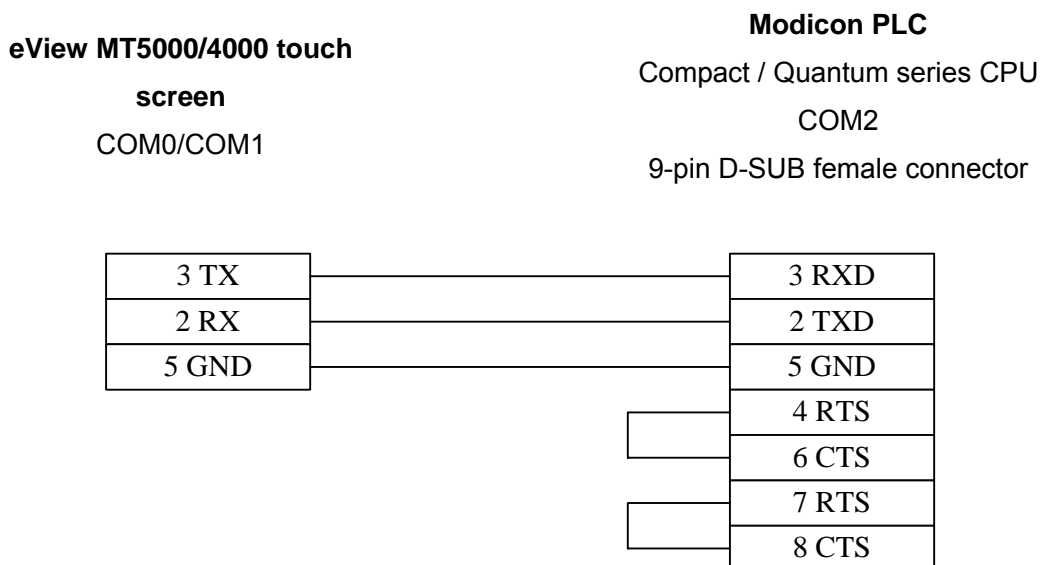

Note: Modbus serial ports of the CPU A984 and E984 241/245/251/255 of the Compact series, and the Modbus serial ports of the Quantum 140CPU series are all 9-pin RS-232 hardware interfaces. Where, A984-131/141 and E984-241/251 of the Compact series and the 140CPU 434/534 of the Quantum series have two Modbus ports. The wiring diagram is shown in the above figure. For related software and hardware settings, refer to the technical manuals provided by Schneider Electric.

4. Communication module (172 JNN 210 32 applicable to Momentum series)

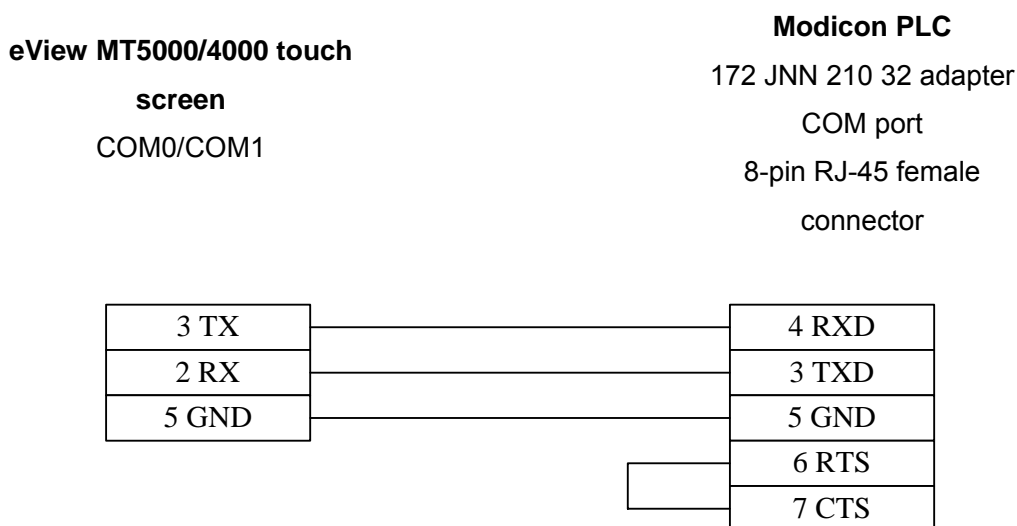

eView MT5000/4000 touch screen
COM0/COM1

Modicon PLC
172 JNN 210 32 adapter
COM port
8-pin RJ-45 female connector



Note: When the 172 JNN 210 32 adapter is configured with CPU 171CCS 780 or 171 CCC 780, the RS-485 port on the adapter becomes unavailable. For related software and hardware settings, refer to the technical manuals provided by Schneider Electric.

5. Communication module (NOM 21X 00 applicable to Quantum series PLC RS232)

eView MT5000/4000 touch screen
COM0/COM1

Modicon PLC
NOM 21X 00 series adapter
COM port
9-pin D-SUB female connector

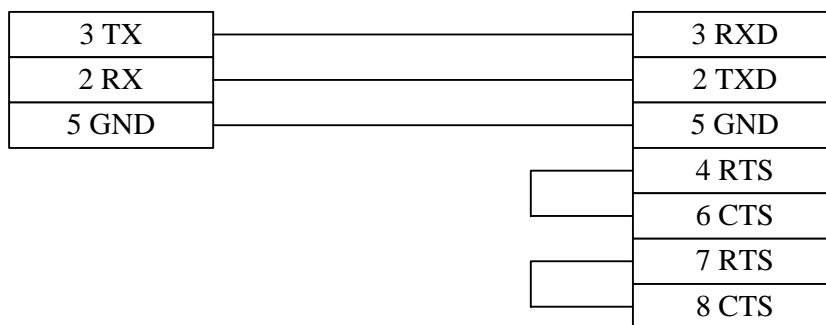

14.6 FACON PLC



Connection of FACON FB Series PLC with eView MT5000/4000 Touch Screen

- EV5000 software setting:

Item	Recommended Setting	Optional Setting	Precaution
PLC Type	FACON FB		
COM	COM0/COM1	RS232/RS485	
Data Bits	7	7 or 8	Must be the same as the COM port settings of the PLC
Stop Bits	1	1 or 2	Must be the same as the COM port settings of the PLC
Bits per Second	9600	9600/19200/38400/ 57600/115200	Must be the same as the COM port settings of the PLC
Parity	Even parity	Even parity/odd parity/none	Must be the same as the COM port settings of the PLC
PLC Station No.	1	0-255	Must be the same as the COM port settings of the PLC

- ◆ PLC software setting:

Please refer to related PLC programming software user manuals.

Reference website: [HTTP://www.fatek.com](http://www.fatek.com)

- Operable address range:

PLC Address Type	Operable Range	Format	Description
X	0-9999	DDD	External input node
Y	0-9999	DDD	External output node
M	0-9999	DDD	Internal auxiliary node
S	0-9999	DDD	Sequence control node
T	0-9999	DDD	Timer node
C	0-9999	DDD	Counter node
HR	0-9999	DDD	Data register
DR	0-9999	DDD	Data register
TMR	0-9999	DDD	Timer buffer
CTR	0-9999	DDD	Counter buffer

Note: D indicate decimal notation. The operable range in the above table indicates the operable range of the MT5000/4000 touch screen. The actual range of the PLC may be broader or narrower than this range.

• **Detailed wiring diagram:**

Note: FACON FB series of PLCs cover two series of MA and MC and such models as FBE –20/28/40MA, FBE –20/28/40MC and FBN –19/26/36MCT. Where, MA series standard CPUs provide one HCMOS serial port, and MC series provide three serial ports (1 HCMOS & 1 RS-232 & 1 RS-485). MA series of CPUs have to be connected with the touch screen only after converting HCMOS into RS-232/RS-485 through the commutation interface module FB-DTBR or FB-DTBR-E.

1. CPU

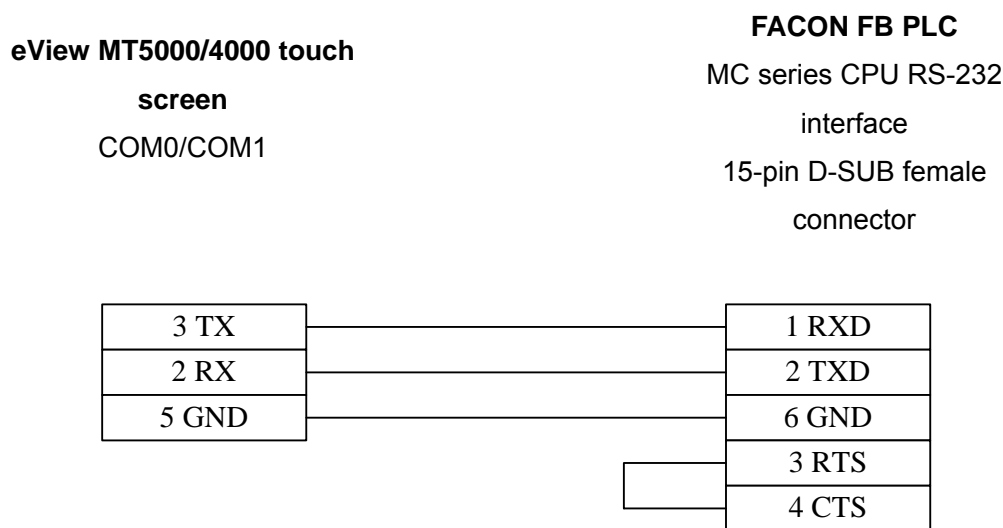

2. Communication module FB-DTBR/DTBR-E

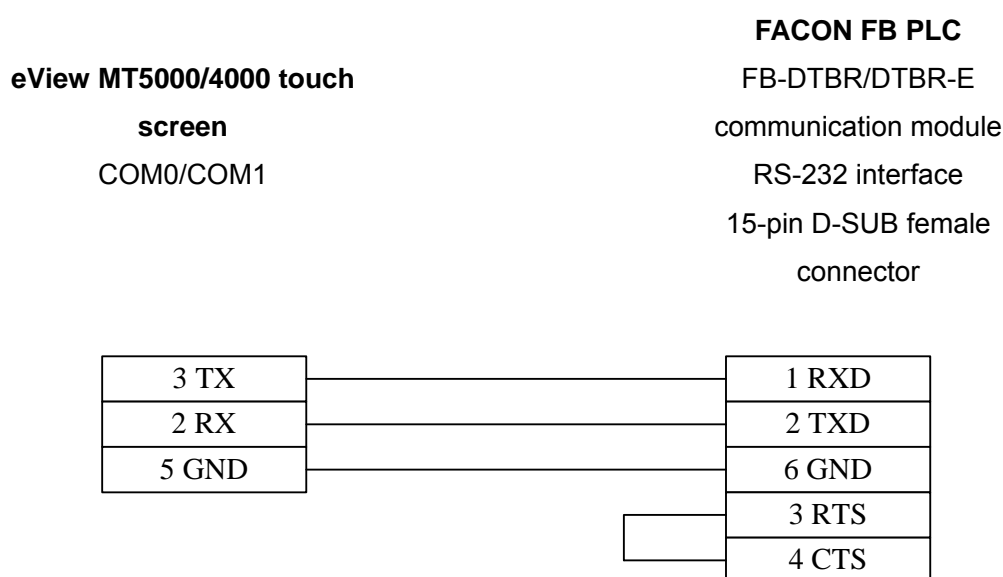

3. Communication module FB-DTBR/DTBR-E

**eView MT5000/4000 touch
screen**
COM0/COM1

FACON FB PLC
FB-DTBR/DTBR-E
communication module
RS-232 interface
9-pin D-SUB female
connector

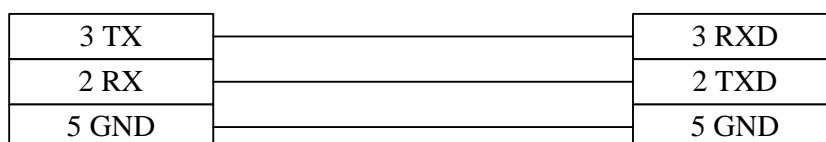

4. Communication module FB-DTBR/DTBR-E

**eView MT5000/4000 touch
screen**
COM0/COM1

FACON FB PLC
FB-DTBR/DTBR-E
communication module
RS-485 port
3-pin terminal block

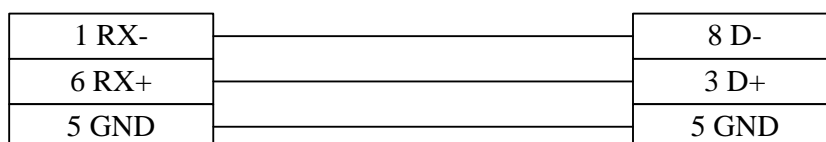

14.7 SIEMENS PLC



Connection of SIEMENS S7200 Series PLC with eView MT5000/4000 Touch Screen

- EV5000 software setting:

Item	Recommended Setting	Optional Setting	Precaution
PLC Type	SIEMENS S7/200		
COM	COM0/COM1	RS232/RS485	
Data Bits	8	7 or 8	Data bits for this protocol

			are set to 8 in a fixed manner
Stop Bits	1	1 or 2	Must be the same as the COM port settings of the PLC
Bits per Second	9600	9600/19200/38400/ 57600/115200	Must be the same as the COM port settings of the PLC
Parity	Even parity	Even parity/odd parity/none	Must be the same as the COM port settings of the PLC
PLC Station No.	2	0-255	Must adopt the recommended settings

◆ PLC software setting:

Set PLC address to 2.

Please refer to related PLC programming software user manual of SIEMENS.

Reference website: [Http://www.siemens.com/s7-200](http://www.siemens.com/s7-200)

● Operable address range:

PLC Address Type	Operable Range	Format	Description
I	0-4095.7	DDDO	External input node
Q	0-4095.7	DDDO	External output node
M	0-4095.7	DDDO	Internal auxiliary node
VW	0-5120	DDDD	Data register

Note: D indicates decimal notation, O indicates octal notation, and the value range is 0 ~7. Note that the start bit of the VW address must be an even number.

If it is necessary to operate the double word variable, select 2 in the corresponding component address properties dialog box.

The operable range in the above table indicates the operable range of the MT5000/4000 touch screen. The actual range of the PLC may be broader or narrower than this range.

● Detailed wiring diagram:

Note: SIEMENS S7-200 series PLCs cover such models as CPU212, CPU214, CPU215, CPU216,

CPU221, CPU222, CPU224 and CPU226. All of them can be connected with the eView touch screen through the programming communication port (PPI port) on the CPUs. Where, CPU226 has two communication ports: either one can be used to connect the touch screen, but the communication parameters for them have to be set separately. While connecting PLC directly with the touch screen through the CPU, pay attention to the setting of communication parameters in the software. For detailed settings, refer to the technical manuals provided by SIEMENS.

1. CPU

eView MT5000/4000 touch screen	SIEMENS PLC
COM0/COM1	S7-200 series CPU
485	PPI COM port
	485

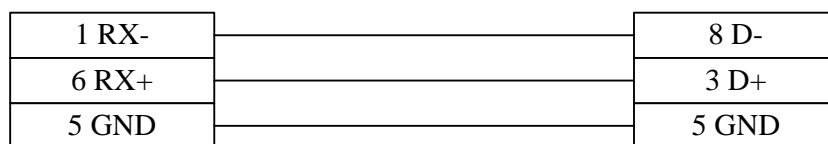

Connection of SIEMENS S7300 Series PLC with eView MT5000/4000 Touch Screen

- EV5000 software setting:

Item	Recommended Setting	Optional Setting	Precaution
PLC Type	SIEMENS S7/300 HMI adapter	SIEMENS S7/300 HMI adapter SIEMENS S7/300 PC adapter	Select corresponding type according to different communication adapters*
COM	COM0/COM1	RS232/RS485	
Data Bits	8	7 or 8	Data bits for this protocol are set to 8 in a fixed manner
Stop Bits	1	1 or 2	Must be the same as the COM port settings of the PLC
Bits per Second	9600/19200	9600/19200/38400/ 57600/115200	Must be the same as the COM port settings of the PLC

Parity	Odd parity	Even parity/odd parity/none	Must be the same as the COM port settings of the PLC
Human-machine station No.	0	0-255	It is not required to set this protocol
PLC Station No.	2	0-255	Must adopt recommended settings
Multiple human-machine interconnection	Disabled	Disabled/Master/Slave	Applicable only to multiple human-machine interconnection
Human-machine interconnection rate	38400	38400/115200	Applicable only to multiple human-machine interconnection
PLC timeout constant	3.0	1.5-5.0	Adopt default settings
PLC packet	0	0-10	Recommended value range: 0-10

Note: The part number of SIEMENS S7/300 HMI adapter is 6ES7972-0CA10-0XA0, and that of SIEMENS S7/300 PC adapter is 6ES7972-0CA23-0XA0. When a PC adapter is used, the baud rate (bits per second) can be set to 19200 or 38400 only, depending on the setting of the DIP switch on the adapter. For details, refer to the product catalogue of SIEMENS.

- PLC software setting:

It is required to create data block DB10.

For creation procedures, please refer to related PLC programming software user manual of SIEMENS.

Reference website: [Http://www.aut.sea.siemens.com/s7-300](http://www.aut.sea.siemens.com/s7-300)

- Operable address range:

PLC类型选择为: PC adapter

PLC 地址类型	可操作范围	格式	说明
I	0-4095.7	DDDO	外部输入节点
Q	0-4095.7	DDDO	外部输出节点
M	0-4095.7	DDDO	内部辅助节点
DB10-DB60	0-8192	DDDD	数据寄存器
DB108bit-DB298bit	0-8192.7	DDDD	数据位

PLC类型选择为: HMI adapter

PLC 地址类型	可操作范围	格式	说明
I	0-4095.7	DDDO	外部输入节点
Q	0-4095.7	DDDO	外部输出节点
M	0-4095.7	DDDO	内部辅助节点
DB10	0-8192	DDDD	数据寄存器

Note:

- 1) D indicates decimal notation, O indicates octal notation, and the value range is 0 ~7. Please note that VB10 is DB10, and the start bit of the VB10 address must be an even number.
- 2) If it is necessary to operate the double word variable, select 2 in the corresponding component address properties dialog box.
- 3) The operable range in the above table indicates the operable range of the MT5000/4000 touch screen. The actual range of the PLC may be broader or narrower than this range.

- Detailed wiring diagram:

Note: SIEMENS S7-300 series PLCs cover such models as CPU312, CPU313, CPU314, CPU315, CPU316, and CPU318. All of them can be connected with the eView touch screen through the HMI adapter or PC adapter provided by SIEMENS. Presently, MT5000 series of touch screens do not support CP340 and CP341 communication modules of SIEMENS. When the PLC communicates with S7-300, it is necessary to create the data block DB10. MT5000 series exchange data with the S7-300 through the DB10. When using an adapter, pay attention to the setting of the DIP switch, and it is necessary to define the data format as byte when creating the DB10. For detailed settings, refer to the technical manuals of SIEMENS.

1. HMI adapter 6ES7972-0CA10-0XA0

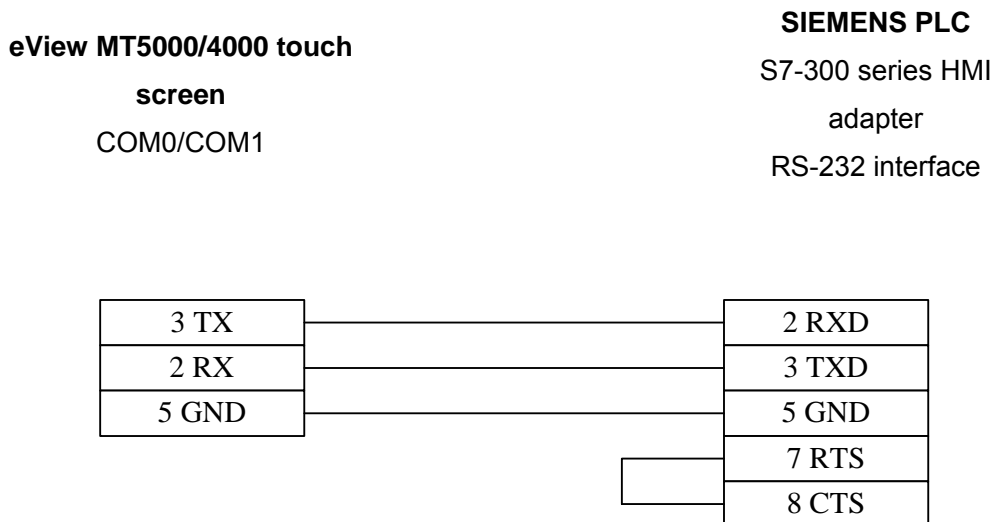

2. PC adapter 6ES7972-0CA23-0XA0

eView MT5000/4000 touch screen
COM0/COM1

SIEMENS PLC
S7-300 series PC adapter
RS-232 interface

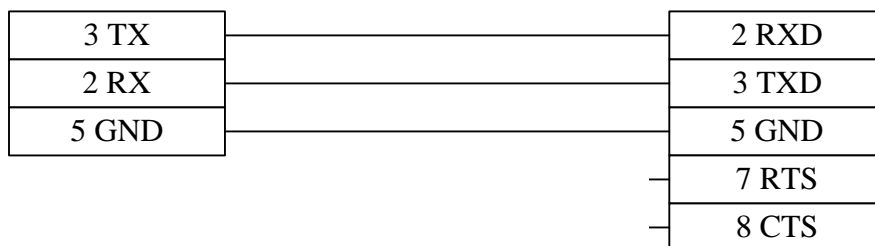

3. MPI adapter MT5-S7-300

eView MT5000/4000 touch screen
COM0/COM1

SIEMENS PLC
eView compatible PMI adapter
MT5-S7-300 RS-232 interface

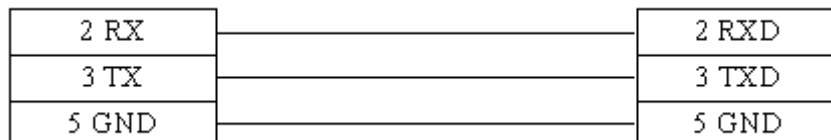

14.8 LG PLC



LG Industrial Systems

Connection of LG Master K Series PLC with eView MT5000/4000 Touch Screen

- EV5000 software setting:

Item	Recommended Setting	Optional Setting	Precaution
PLC Type	LG MASTER-K Cnet	LG MASTER-K300S CPU / LG MASTER-K Cnet/ LG MODBUS RTU	Select different PLC type according to different PLCs
COM	COM0/COM1	RS232/RS485	
Data Bits	8	7 or 8	Must be the same as the

			COM port settings of the PLC
Stop Bits	1	1 or 2	Must be the same as the COM port settings of the PLC
Bits per Second	38400	9600/19200/38400/ 57600/115200	Must be the same as the COM port settings of the PLC
Parity	None	Even parity/odd parity/none	Must be the same as the COM port settings of the PLC
PLC Station No.	0	0-31	Must be the same as the COM port settings of the PLC

Note: In the case of Master-K 80S series, set LG MASTER-K300S CPU. The “Bits per second” must be set to 38400. The user can also set LG MASTER-K Cnet, but shall pay attention to the setting of the DIP switch. Only Cnet protocol supports PLC station No.

- PLC software setting:

Please refer to related PLC programming software user manual of LG Industrial Systems.

Reference website: [Http://www.lgis.com](http://www.lgis.com).

- Operable address range:

PLC Address Type	Operable Range	Format	Description
P	0-255F	DDD(H)	Input/output node
K	0-255F	DDD(H)	Holding node
M	0-255F	DDD(H)	Internal auxiliary node
L	0-255F	DDD(H)	Link relay node
F	0-255F	DDD(H)	Special relay node
T/C	0-255	DDD	Timer/counter node
D	0-9999	DDD	Data register

Note: D indicates decimal notation, H indicates hexadecimal notation, and the value range is 0 ~ F. It supports T and C nodes only when LG K10S1 is adopted.

The operable range in the above table indicates the operable range of the MT5000/4000 touch screen. The actual range of the PLC may be broader or narrower than this range.

- Detailed wiring diagram:

Note: LG Master K series PLCs cover independent type and substrate type. Where, the independent type covers LG Master K 10S1/10S/30S/60S/80S series of CPUs, and the substrate type covers LG Master K200S/300S/1000S series of CPUs. They all can be connected with the eView touch screen through the communication port on their respective CPUs. In addition, Master K80S/200S/300S/1000S series of CPUs can be connected through the extended Cnet module. Please note that different PLC types must be set in the touch screen software when different PLC CPUs are adopted. When Cnet protocol is used, pay attention to the setting of communication protocols. For setting methods, refer to operating instructions provided by LG Industrial Systems.

1. CPU (K10S1/K10S/K30S/K60S/K80S/K200S/K300S/K1000S RS232)

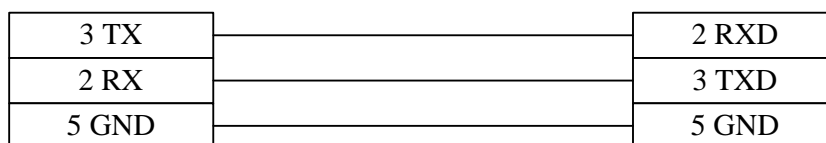

Note: When K10S1 is used, the “Bits per second” in the touch screen software must be set to 9600. When K10S/K30S/K60S/K100S are used, the PLC type must be set to LG K60S and the “Bits per second” to 9600. When K80S/K200S/K300S/K1000S are used, the PLC type must be set to LG MASTER-K300S CPU and the “Bits per second” to 38400. Where, K10S1/K10S provide 6-pin mini DIN round interface.



6-Pin Mini DIN Interface

2. CPU (K80S/K200S/K300S/K1000S Cnet RS232)

**eView MT5000/4000 touch
screen**
COM0/COM1

LG Master K PLC
Master K series
CPU RS-232 interface
9-pin D-SUB female
connector

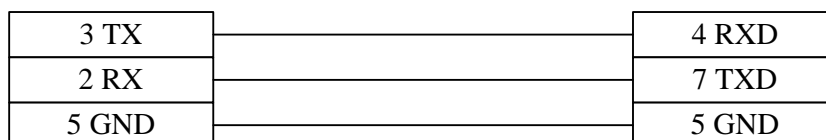

Note: When the Cnet communication mode of K80S/K200S/K300S/K1000S is used, set the PLC type to LG MASTER-K Cnet. The setting of communication parameters must be consistent with that of the touch screen.

3. CPU (LG Master K200S CPU K3P-07BS RS422)

**eView MT5000/4000 touch
screen**
COM0/COM1

LG Master K PLC
Master K200 series CPU
RS-422 interface
5-pin terminal block

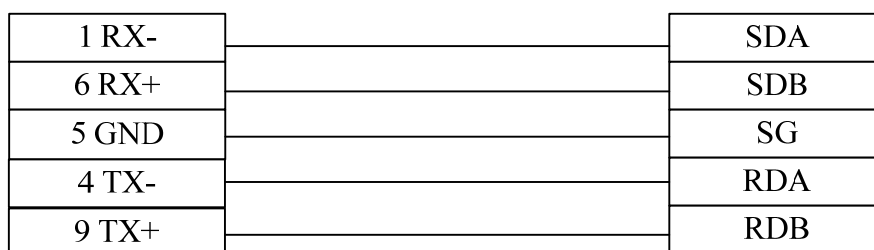

Note: Only K200S CPU K3P-07BS provides built-in RS-422/485 port. Set the PLC type to LG MASTER-K Cnet, and pay attention to the setting of communication parameters.

4. Communication module (G7L-CUEB / G6L-CUEB / G4L-CUEA / G3L-CUEA Master K Cnet RS232)

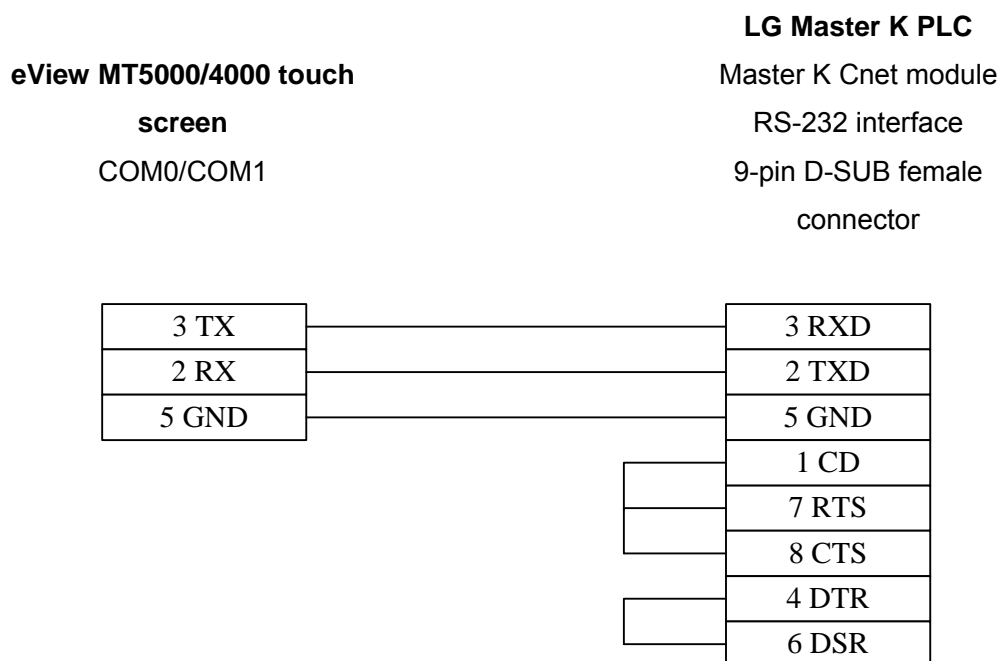

5. Communication module (G7L-CUEC / G6L-CUEC / G4L-CUEA / G3L-CUEA Master K Cnet RS422)

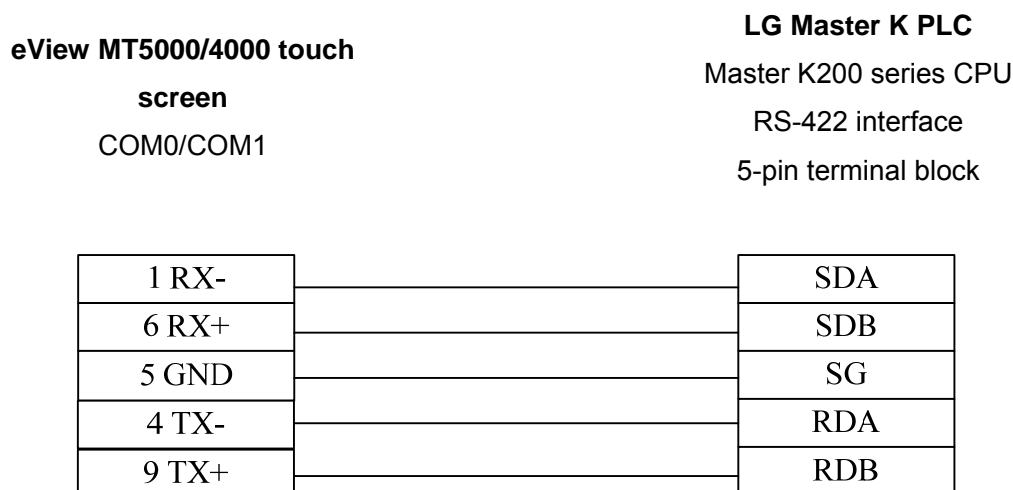

Note: When the Cnet module is used, the PLC type must be set to LG MASTER-K Cnet. Pay attention to the setting of communication parameters. It is necessary to use the Cnet Frame Editor software provided by LG to set the parameters. Set the mode switch on the communication module to position 3.

14.9 Matsushita PLC



Matsushita Electric

Connection of NAIS FP Series PLC with eView MT5000/4000 Touch Screen

- EV5000 software setting:

Item	Recommended Setting	Optional Setting	Precaution
PLC Type	Matsushita FP		
COM	COM0/COM1	RS232/RS485	Select different types according to different ports
Data Bits	8	7 or 8	Must be the same as the COM port settings of the PLC
Stop Bits	1	1 or 2	Must be the same as the COM port settings of the PLC
Bits per Second	9600	9600/19200/38400/ 57600/115200	Must be the same as the COM port settings of the PLC
Parity	Odd parity	Even parity/odd parity/none	Must be the same as the COM port settings of the PLC
PLC Station No.	1	0-255	Must be the same as the COM port settings of the PLC *

Note: The PLC station No. for FP series is usually 1 by default. However, due to special control of FP3, its PLC station No. must be 0. Pay attention to the communication settings of the PLC during connection.

- PLC software setting:

Please refer to related PLC programming software user manual of NAIS.

Reference website: [Http://www.aromat.com](http://www.aromat.com)

- Operable address range:

PLC Address Type	Operable Range	Format	Description
X	0-9999F	DDD(H)	External input node
Y	0-9999F	DDD(H)	External output node

R	0-9999F	DDD(H)	Internal auxiliary node
L	0-9999	DDD	Link control node
T	0-9999	DDD	Timer node
C	0-9999	DDD	Counter node
SV	0-9999	DDD	Set value register of timer/counter
EV	0-9999	DDD	Actual value register of timer/counter
DT	0-9999	DDD	Data register

Note: D indicates decimal notation, H indicates hexadecimal notation, and the value range is 0 ~ F.

The operable range in the above table indicates the operable range of the MT5000/4000 touch screen. The actual range of the PLC may be broader or narrower than this range.

- Detailed wiring diagram:

Note: NAIS FP series PLCs cover FP0, FP1, FP2, FP2SH, FP10SH and FP3 series. All of them can be connected with the eView MT5000/4000 series touch screens through the programming interface or communication port on their respective CPUs. For detailed hardware settings, refer to the technical manuals provided by Matsushita Electric.

1. CPU RS232

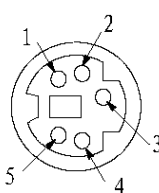
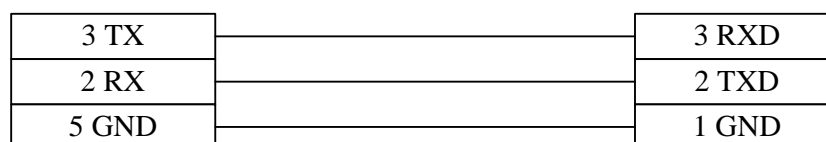
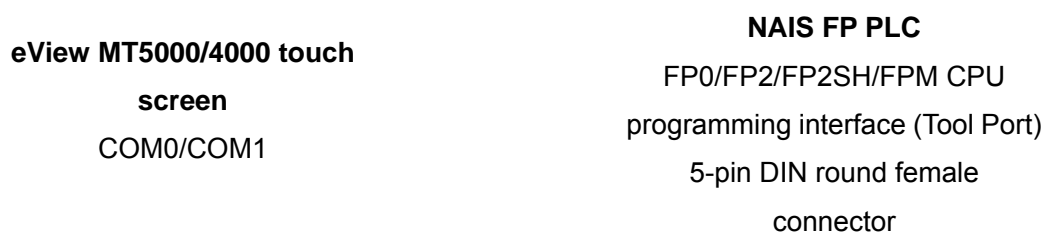

5 Pin Mini DIN Connector

**eView MT5000/4000 touch
screen
COM0/COM1**

**NAIS FP PLC
FP0 CPU RS232 COM port
3-pin terminal block**

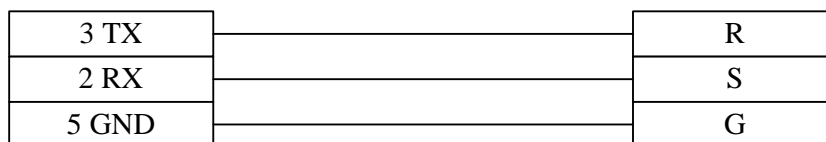

Note: In the FP0 series, only FP0-C××C×× models support RS-232 interfaces.

**eView MT5000/4000 touch
screen
COM0/COM1**

**NAIS FP PLC
FP1/FP2/FP2SH/FP10SH CPU
RS232 COM port**

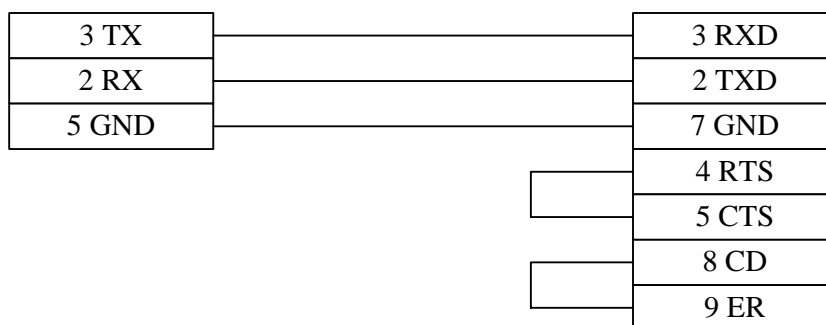

Note: In the FP1 series, only FP1-C××C models support 9-pin RS-232 interfaces. The tool port of the FP10SH can also be used to connect with the touch screen. The wiring method is shown in the above figure.

2. CPU RS422/485

**eView MT5000/4000 touch
screen
COM0/COM1**

**NAIS FP PLC
FP1 CPU RS422
programming interface
Round Hirose 8-Pin Port**



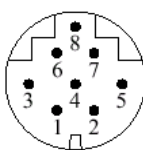

Hirose 8 Pin Port

**eView MT5000/4000 touch
screen
COM0/COM1**

**NAIS FP PLC
FP3 CPU RS422
programming interface
15-pin D-SUB female
connector**

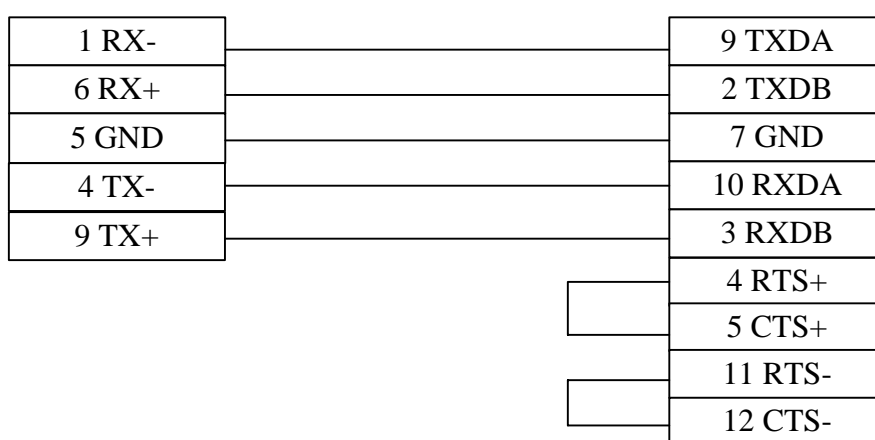

Note: For detailed software and hardware settings, refer to the technical manuals provided by Matsushita Electric.

14.10 DELTA PLC



Connection of DELTA DVP Series PLC with eView MT5000/4000 Touch Screen

- EV5000 software setting:

Item	Recommended Setting	Optional Setting	Precaution
PLC Type	DELTA DVP		
COM	COM0/COM1	RS232/RS485	
Data Bits	7	7 or 8	Must be the same as the COM port settings of the PLC

Stop Bits	1	1 or 2	Must be the same as the COM port settings of the PLC
Bits per Second	9600	9600/19200/38400/ 57600/115200	Must be the same as the COM port settings of the PLC
Parity	Even parity	Even parity/odd parity/none	Must be the same as the COM port settings of the PLC
PLC Station No.	1	0-255	Must be the same as the COM port settings of the PLC

◆ PLC software setting:

Please note that the setting of the PLC station No. must be consistent with that of the touch screen software.

Please refer to related PLC programming software user manual of Delta.

Reference website: [Http://www.deltadrivers.com](http://www.deltadrivers.com)

◆ Operable address range:

PLC Address Type	Operable Range	Format	Description
X	0-9999	OOO	External input node
Y	0-9999	OOO	External output node
M	0-9999	DDD	Internal auxiliary node
S	0-9999	DDD	Sequence control node
T	0-9999	DDD	Timer node
C	0-9999	DDD	Counter node
TV	0-9999	DDD	Timer buffer
CV	0-127	DDD	Counter buffer
CV2	232-255	DDD	Counter buffer (double word 32 bits)
D	0-9999	DDDD	Data register

Note: D indicates decimal notation, O indicates octal notation, and the value range is 0 ~7.

The operable range in the above table indicates the operable range of the MT5000/4000 touch screen. The actual range of the PLC may be broader or narrower than this range.

● Detailed wiring diagram:

Note: DELTA DVP series PLCs covers such models as DVP- 14/24/32/60ES00 and DVP-XXES01.

All of them can be connected with the eView touch screen through the programming

communication port on their respective CPUs. For detailed hardware description, refer to the technical manuals provided by Delta.

1. CPU

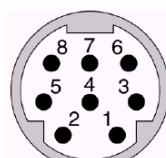
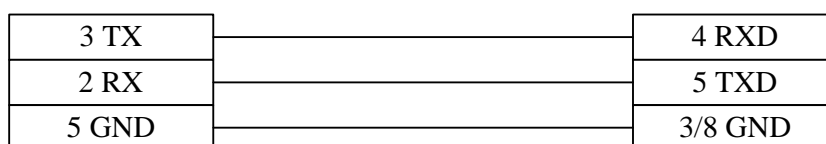

Mini Din 8-Pin Port

14.11 MODBUS RTU Controller

Connection of MODBUS RTU Controller with MT5000/4000 Touch Screen

- EV5000 software setting:

Item	Recommended Setting	Optional Setting	Precaution
PLC Type	Modbus RTU		
COM	COM0/COM1	RS232/RS485	
Data Bits	8	7 or 8	Must be the same as the COM port settings of the controller
Stop Bits	1	1 or 2	Must be the same as the COM port settings of the controller
Bits per Second	9600	9600/19200/38400 / 57600/115200	Must be the same as the COM port settings of the controller

Parity	None	Even parity/odd parity/none	Must be the same as the COM port settings of the controller
PLC Station No.	1	0-31	Must be the same as the COM port settings of the controller

◆ Controller software setting:

It is necessary to set the communication protocol of the communication port of the controller to Modbus RTU mode.

Please refer to the specifications provided by Schneider Electric related to MODBUS protocol and user manuals provided by related controller manufacturers.

Reference website: [Http://www.modicon.com](http://www.modicon.com) / [Http://www.modbus.org](http://www.modbus.org)

● Operable address range:

PLC Address Type	Operable Range	Format	Description
0x	1-9999	DDDD	System internal/external output node
1x	1-9999	DDDD	System internal/external input node
3x	1-9999	DDDD	Analog input data register
4x	1-9999	DDDD	Data register

Note: D indicate decimal notation.

If it is necessary to operate the double word variable, select 2 in the corresponding component address properties dialog box.

The operable range in the above table indicates the operable range of the MT5000/4000 touch screen. The actual range of the PLC may be broader or narrower than this range.

● Detailed wiring diagram:

Note: The eView MT5000/4000 series touch screens can communicate with the controller through the Modbus RTU protocol, so all controllers supporting the Modbus RTU protocol and serial communication can be connected with such touch screens. They support 01-05 and 16 commands of the MODBUS RTU protocol. For detailed functional commands, refer to manuals provided by Modicon. For related hardware and software settings, refer to the technical manuals provided by related controller manufacturers.

1. MODBUS port RS-232

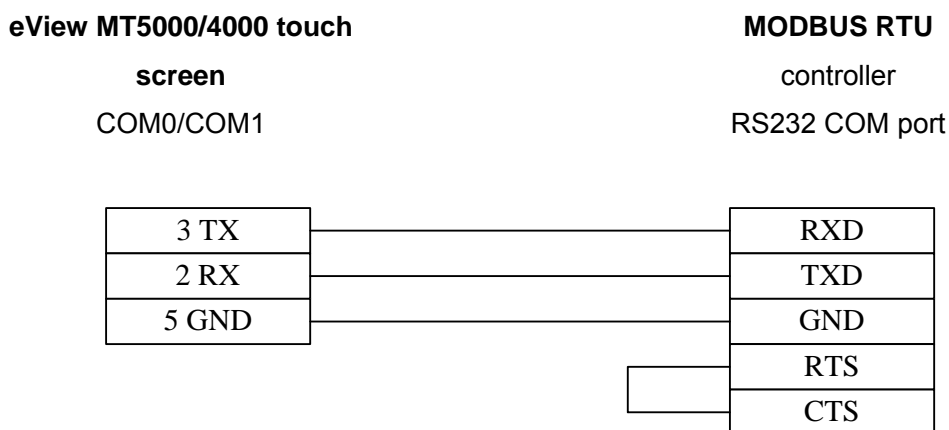

2. MODBUS Port RS422/485

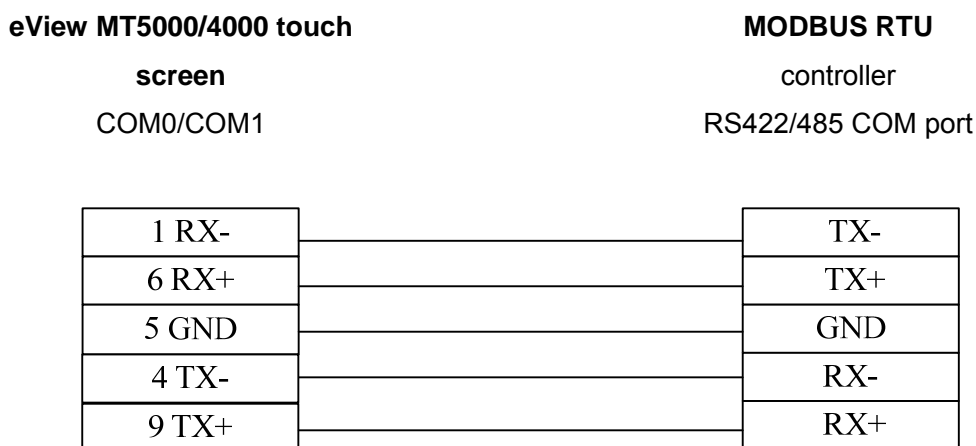

14.12 MODBUS ASCII Controller

Connection of MODBUS ASCII Controller with MT5000/4000 Touch Screen

- EV5000 software setting:

Item	Recommended Setting	Optional Setting	Precaution
PLC Type	Modbus ASCII		
COM	COM0/COM1	RS232/RS485	
Data Bits	8	7 or 8	Must be the same as the COM port settings of the controller

Stop Bits	1	1 or 2	Must be the same as the COM port settings of the controller
Bits per Second	9600	9600/19200/38400/57600/115200	Must be the same as the COM port settings of the controller
Parity	Even parity	Even parity/odd parity/none	Must be the same as the COM port settings of the controller
PLC Station No.	1	0-31	Must be the same as the COM port settings of the controller

◆ Controller software setting:

It is necessary to set the communication protocol of the communication port of the controller to Modbus ASCII mode.

Please refer to the specifications provided by Schneider Electric related to MODBUS protocol and user manuals provided by related controller manufacturers.

Reference website: [Http://www.modicon.com](http://www.modicon.com) / [Http://www.modbus.org](http://www.modbus.org)

● Operable address range:

PLC Address Type	Operable Range	Format	Description
0x	1-9999	DDDD	System internal/external output node
1x	1-9999	DDDD	System internal/external input node
3x	1-9999	DDDD	Analog input data register
4x	1-9999	DDDD	Data register

Note: D indicates decimal notation.

If it is necessary to operate the double word variable, select 2 in the corresponding component address properties dialog box.

The operable range in the above table indicates the operable range of the MT5000/4000 touch screen. The actual range of the PLC may be broader or narrower than this range.

- Detailed wiring diagram:

Note: The eView MT5000/4000 series touch screens can communicate with the controller through the Modbus ASCII protocol, so all controllers supporting the Modbus ASCII protocol and serial communication can be connected with such touch screens. They support 01-05 and 16 commands of the Modbus ASCII protocol. For detailed functional commands, refer to manuals provided by Modicon. For related hardware and software settings, refer to the technical manuals provided by related controller manufacturers.

1. MODBUS port RS-232

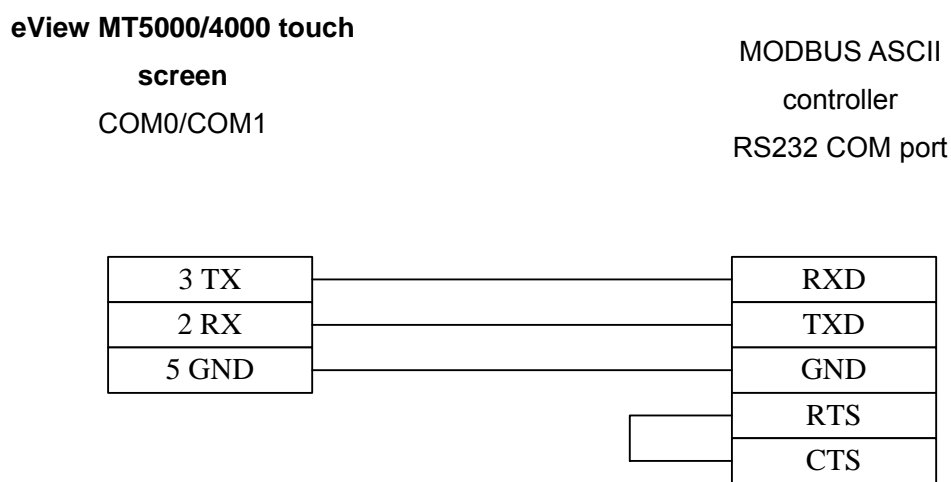

2. MODBUS port RS-422/485

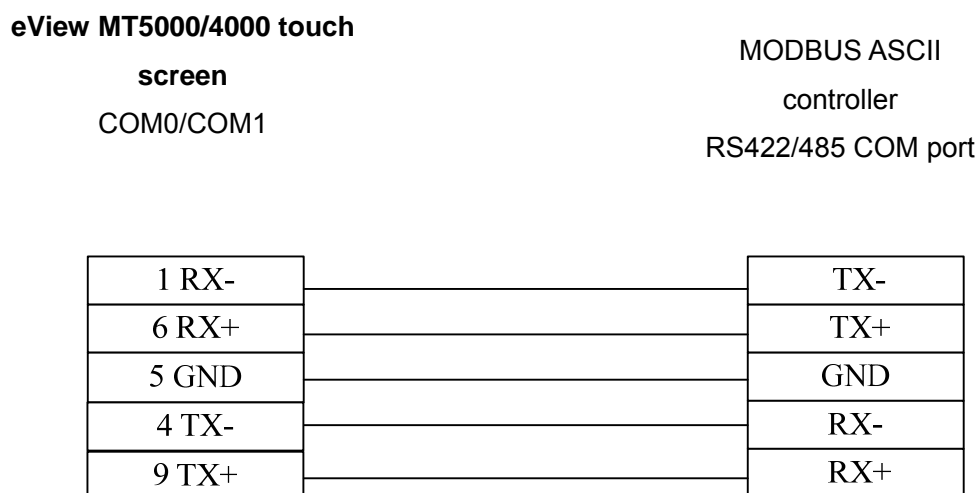

14.13 VIGOR PLC

Connection of VIGOR VB Series PLC with eView MT5000/4000 Human-machine Interfaces

- EV5000 software setting:

Item	Recommended Setting	Optional Setting	Precaution
PLC Type	VIGOR		
COM	COM0/COM1	RS232/RS485	
Data Bits	7	7 or 8	Must be the same as the COM port settings of the PLC
Stop Bits	1	1 or 2	Must be the same as the COM port settings of the PLC
Bits per Second	19200	9600/19200/38400/ 57600/115200	Must be the same as the COM port settings of the PLC
Parity	Even parity	Even parity/odd parity/none	Must be the same as the COM port settings of the PLC
PLC Station No.	0	0-255	Must be the same as the COM port settings of the PLC

- ◆ PLC software setting:

Please note that the setting of the PLC station No. must be consistent with that of the touch screen software.

- ◆ Operable address range:

PLC Address	Operable Range	Format	Description
X	0-255	OOO	External input node
Y	0-255	OOO	External output node
M	0-5119	DDD	Internal auxiliary node
SM	9000-9255	DDD	Special auxiliary node
T_bit	0-255	DDD	Timer node
C_bit	0-255	DDD	Counter node
T_word	0-255	DDD	Timer buffer
C_word	0-199	DDD	Counter buffer
CV2	200-255	DDD	Counter buffer (double)
D	0-7999	DDD	Data register
SD	9000–9255	DDD	Special data register

- Detailed wiring diagram:

1. PLC setting:

When the communication is conducted through the auxiliary interface of the programming device, no special setting is required. When the communication is conducted through the extended communication module VB-232 or VB-485, it is necessary to set the protocol of the extended communication port to “**Computer Link**”, set the station No. to 0, and set the “Bits per second” to 19200.

2. Wiring diagram:

2.1 Communication via auxiliary interface of VB programming device:

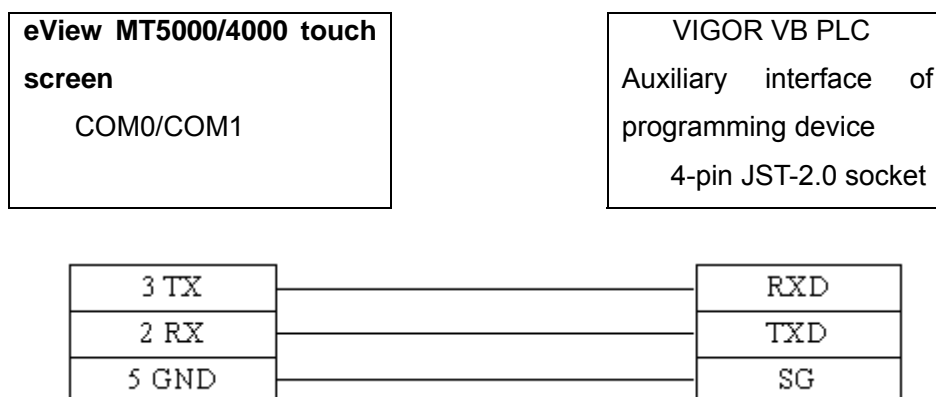

2.2 Communication via VB-232 extended port:

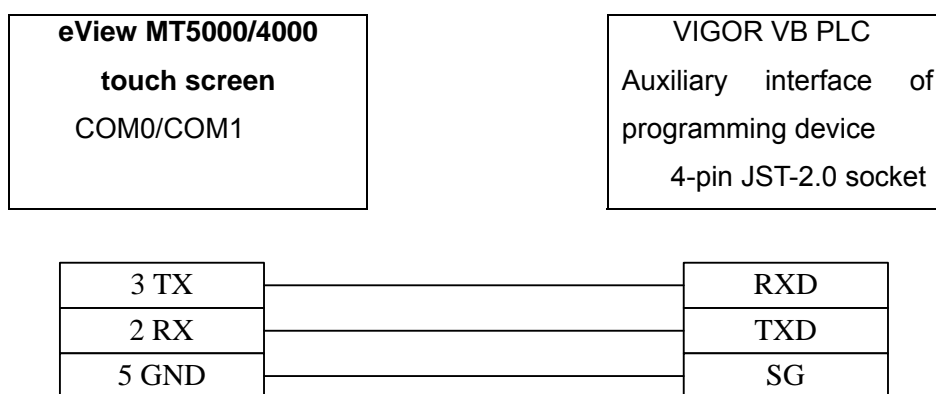

2.3 Communication via VB-485 extended port:

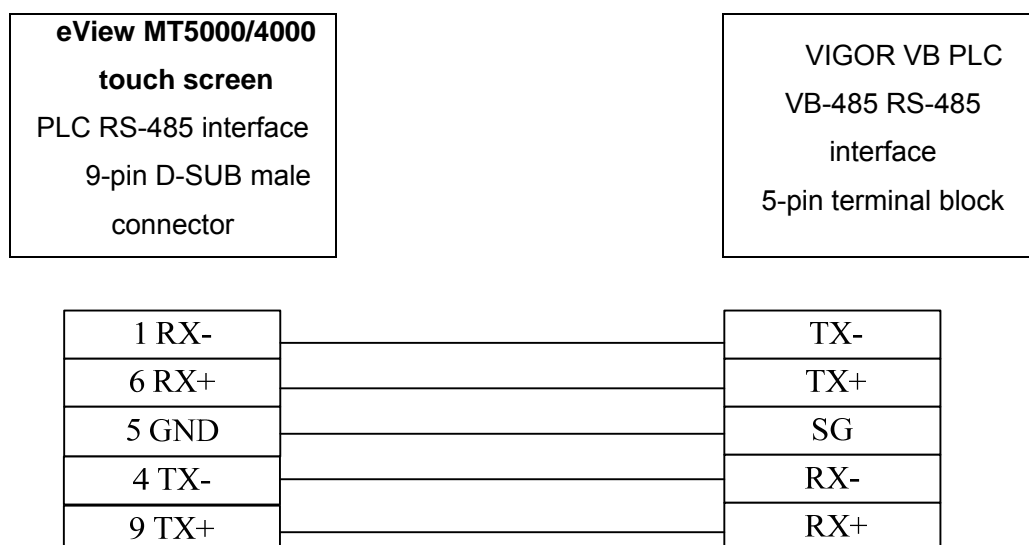

14.14 EMERSON PLC



EMERSON

Connection of EMERSON EC20 Series PLC and eView MT5000/4000 Series Human-machine Interface

- EV5000 software setting:

Item	Recommended Setting	Optional Setting	Precaution
PLC Type	Emerson (Modbus)		
COM	RS232	RS232/RS485	
Data Bits	8	7 or 8	Must be the same as the COM port settings of the controller
Stop Bits	1	1 or 2	Must be the same as the COM port settings of the controller
Bits per Second	19200	9600/19200/38400/ 57600/115200	Must be the same as the COM port settings of the controller
Parity	Even parity	Even parity/odd parity/none	Must be the same as the COM port settings of the controller
PLC Station No.	1		Must be the same as the COM port settings of the controller

◆ Controller software setting:

1. It is necessary to set the communication protocol of the communication port of the controller to

Modbus Slave mode.

Please refer to user manuals provided by EMERSON.

Reference website: <Http://www.emersonnetworkpower.com.cn>

◆ **Operable address range:**

Bit/Word	PLC Address Type	Operable Range	Format	Description
Bit	X	0-377	OOO	System internal/external output node
Bit	Y	0-377	OOO	System internal/external input node
Bit	M	0-1999	DDDD	Intermediate auxiliary register
Bit	SM	0-255	DDDD	
Bit	S	0-991	DDD	Stepping status relay
Bit	T_bit	0-255	DDD	Timer
Bit	C_bit	0-255	DDD	Counter
Word	D	0-7999	DDDD	Data register
Word	SD	0-255	DDD	
Word	Z	0-15	DD	
Word	T_word	0-255	DDD	Timer
Word	C_word	0-199	DDD	
Dword	D_double	0-3999	DDDD	Data register
Dword	SD_double	0-127	DDD	
Dword	C_double	200-255	DD	Counter

Note: O indicates octal notation.

D indicates decimal notation.

The operable range in the above table indicates the operable range of the MT5000/4000 touch screen. The actual address in the touch screen shall be 1 greater than the PLC address.

For example, to read M0 in the PLC, write the address M1 in the touch screen configuration software.

◆ Detailed wiring diagram:

1. Emerson port RS-232

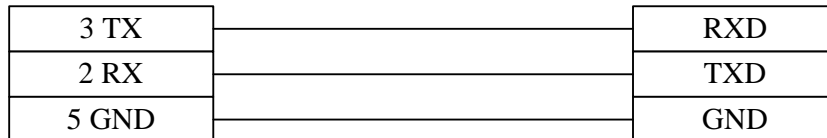

2. Emerson port 485

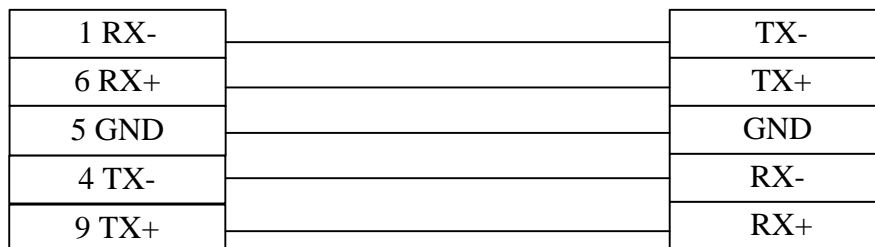
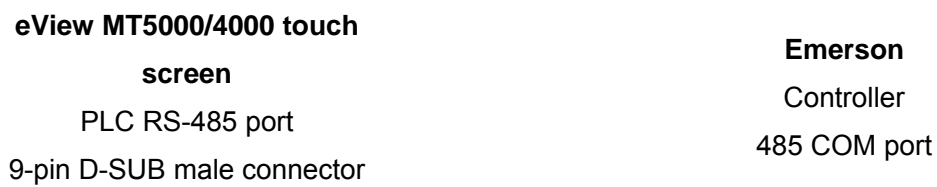

14.15 KEYENCE PLC



Connection of KEYENCE KV1000 Series PLC with MT5000/4000 Touch Screen

- EV5000 software setting:

Item	Recommended Setting	Optional Setting	Precaution
PLC Type	KEYENCE KV1000		
COM	RS232	RS232/RS485	
Data Bits	8	7 or 8	Must be the same as the COM port settings of the controller
Stop Bits	1	1 or 2	Must be the same as the COM port settings of the controller
Bits per Second	9600	9600/19200/38400/ 57600/115200	Must be the same as the COM port settings of the controller
Parity	Even parity	Even parity/odd parity/none	Must be the same as the COM port settings of the controller
PLC Station No.	0		Must be the same as the COM port settings of the controller

◆ Controller software setting:

Please refer to user manuals provided by Keyence.

Reference website: <http://china.keyence.com/>

◆ Operable address range:

Bit/Word	PLC Address Type	Operable Range	Format	Description
Bit	R	0-59915	DDDDD	Relay
Bit	CR	0-3915	DDDD	Control relay
Bit	MR	0-65535	DDDDD	Internal auxiliary relay
Bit	LR	0-65535	DDDDD	Lock relay
Bit	CTC_contact	0-3	D	CTC (High-speed counter comparator)
Word	DM	0-65534	DDDDD	Data memory
Word	CM	0-11998	DDDDD	Control memory
Word	TM	0-511	DDD	Temporary data memory
Word	EM	0-65534	DDDD	Extended data memory
Word	FM	0-32766	DDDD	Extended data memory

Note: D indicates decimal notation.

The operable range in the above table indicates the operable range of the PLC. Some register addresses are reserved by the system and cannot be used. For details, refer to Keyence KV1000 user manual.

◆ Detailed wiring diagram:



Connection of KEYENCE KV-16DT Series PLC with MT5000/4000 Touch Screen

◆ EV5000 software setting:

Item	Recommended Setting	Optional Setting	Precaution
PLC Type	KEYENCE KV-16DT		
COM	RS232	RS232/RS485	
Data Bits	8	7 or 8	Must be the same as the COM port settings of the controller
Stop Bits	1	1 or 2	Must be the same as the COM port settings of the controller
Bits per Second	9600	9600/19200/38400/ 57600/115200	Must be the same as the COM port settings of the controller
Parity	Even parity	Even parity/odd parity/none	Must be the same as the COM port settings of the controller
PLC Station No.	0		Must be the same as the COM port settings of the controller

◆ Controller software setting:

Refer to keyence KV-16DT user manual.

Reference website: <http://china.keyence.com/>

◆ **Operable address range:**

Bit/Word	PLC Address Type	Operable Range	Format	Description
Bit	Counter_contact	0-249	DDD	Relay
Bit	Timer_contact	0-249	DDD	Relay
Bit	Relay	0-17915	DDDDD	Relay
Word	Counter_current	0-249	DDD	Counter memory
Word	Counter_preset	0-249	DDD	Counter memory
Word	Timer_current	0-249	DDD	Time data memory
Word	Timer_preset	0-249	DDD	Time data memory
Word	DM	0-1999	DDDD	Data memory
Word	TM	0-31	DD	Temporary data memory

Note: D indicates decimal notation.

The operable range in the above table indicates the operable range of the PLC. Some register addresses are reserved by the system and cannot be used. For details, refer to Keyence KV-16DT user manual.

Please note that this protocol does not support batch transfer of bits or words.

◆ **Detailed wiring diagram**

MT5000/4000 touch screen

PLC RS-232 interface
9-pin D-SUB male connector

KV CPU Port

RJ-12 port

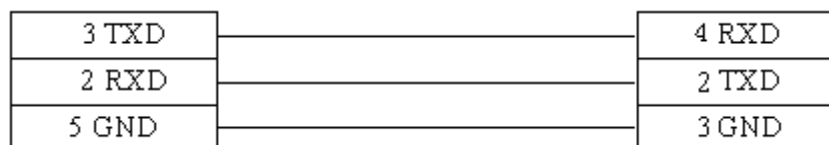

14.16 OEMAX PLC



OEMAX

Connection of OEMAX Series PLC with MT5000/4000 Touch Screen

◆ EV5000 software setting:

Item	Recommended Setting	Optional Setting	Precaution
PLC Type	OEMAX		
COM	RS232	RS232/RS485	
Data Bits	8	7 or 8	Must be the same as the COM port settings of the controller
Stop Bits	1	1 or 2	Must be the same as the COM port settings of the controller
Bits per Second	19200	9600/19200/38400/ 57600/115200	Must be the same as the COM port settings of the controller
Parity	None	Even parity/odd parity/none	Must be the same as the COM port settings of the controller
PLC Station No.	1		Must be the same as the COM port settings of the controller

◆ Controller software setting:

Refer to OEMAX PLC user manuals.

Reference website: <http://www.oemax.com/>

◆ Operable address range:

Bit/Word	PLC Address Type	Operable Range	Format	Description
Bit	R	0.0 – 127.F	DDDH	Input/output node
Bit	L	0.0 – 63.F	DDH	General register
Bit	M	0.0 – 127.F	DDDH	General register
Bit	K	0.0 – 127.F	DDDH	Holding node
Bit	TC	0 – 255	DDD	Timing register
Bit	F	0.0 – 15.F	DDH	Special register
word	R_word	0 - 127	DDD	Internal HSC
word	L_word	0 - 63	DD	General register
word	M_word	0 - 127	DDD	General register
word	K_word	0 - 127	DDD	Holding register
word	F_word	0 - 15	DD	Special register
word	SV_word	0 - 255	DDD	Timer, counter register
word	PV_word	0 - 255	DDD	Timer, counter register
word	W_word	0 - 2047	DDDD	General register

word	SR_word	0 - 511	DDD	Special register
Dword	R_Dword	0 - 127	DDD	Internal HSC
Dword	L_Dword	0 - 63	DD	General register
Dword	M_Dword	0 - 127	DDD	General register
Dword	K_Dword	0 - 127	DDD	Holding register
Dword	F_Dword	0 - 15	DD	Special register
Dword	SV_Dword	0 - 255	DDD	Timer, counter register
Dword	PV_Dword	0 - 255	DDD	Timer, counter register
Dword	W_Dword	0 - 2047	DDDD	General register
Dword	SR_Dword	0 - 511	DDD	Special register

Note: D indicates decimal notation, H indicates hexadecimal notation, and the value range is 0 ~ F.

The operable range in the above table indicates the operable range of the MT5000/4000 touch screen. The actual range of the PLC may be broader or narrower than this range.

◆ **Detailed wiring diagram:**

MT5000/4000 touch screen

PLC RS-232 interface

9-pin D-SUB male connector

OEMAX PLC series CPU

RS-232 interface

9-pin D-SUB female connector

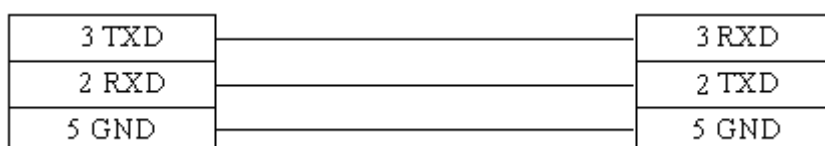

14.17 ABB (07KR51) PLC

Connection of ABB (07KR51) Series PLC with MT5000/4000 Touch Screen

◆ **EV5000 software setting:**

Item	Recommended Setting	Optional Setting	Precaution
PLC Type	ABB (07KR51)		
COM	RS-232	RS232/RS485	
Data Bits	8	7 or 8	Must be the same as the COM port settings of the controller

Stop Bits	1	1 or 2	Must be the same as the COM port settings of the controller
Bits per Second	9600	9600/19200/38400/ 57600/115200	Must be the same as the COM port settings of the controller
Parity	None	Even parity/odd parity/none	Must be the same as the COM port settings of the controller
PLC Station No.	1		Must be the same as the COM port settings of the controller

◆ **Controller software setting:**

Refer to ABB **07KR51** user manuals.

◆ **Operable address range:**

Bit/Word	PLC Address Type	Operable Range	Format	Description
bit	I	00.00 - 68.15	DDH	Input node
bit	O	00.00 - 68.15	DDH	Output node
bit	M	((0 (000.00-099.15)U(233.00-255.15)	DDDH	Internal auxiliary node
bit	S	000.00 - 125.15	DDDH	Link relay node
word	IW	00.00 – 68.15	DDH	Input register
word	OW	00.00 – 68.15	DDH	Output register
word	MW	(000.00-099.15)U(230.00-255.15)	DDDH	Internal register
word	KW	001.00 -031.15	DDH	Indirect current register
Dword	MD	000.00 – 007.15	DH	Internal double word register
Dword	KD	000.01 – 007.15	DH	Indirect double word register

Note: D indicates decimal notation, H indicates hexadecimal notation, and the value range is 0 ~ F.

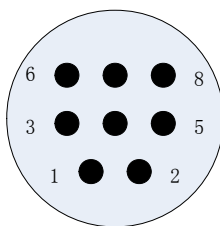

8-pin round male connector

◆ Detailed wiring diagram

ABB 07KR51 series CPU

RS-232 interface

8-pin round male connector

MT5000/4000 touch screen

PLC RS-232 interface

9-pin D-SUB male connector

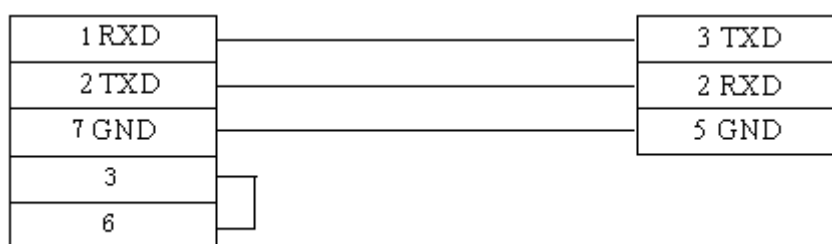

14.18 eView Master and eView Slave (Master/Slave Protocol Connection)

◆ EV5000 software setting:

Item	Recommended Setting	Optional Setting	Precaution
PLC Type	eView Master/ eView Slave		
COM	RS-232	RS232/RS485	
Data Bits	8	7 or 8	Must be the same as the COM port settings of the controller
Stop Bits	1	1 or 2	Must be the same as the COM port settings of the controller
Bits per Second	9600	9600/19200/38400/57600/115200	Must be the same as the COM port settings of the controller
Parity	Even parity	Even parity/odd parity/none	Must be the same as the COM port settings of the controller
PLC Station No.	1		Must be the same as the COM port settings of the controller

◆ **Operable address range:**

Bit/Word	PLC Address Type	Operable Range	Format	Description
bit	B	0 - 8999	DDDD	
word	W	0 - 8999	DDDD	

◆ **Detailed wiring diagram:**

MT5000 /4000 touch screen
 PLC RS-232 interface
 9-pin D-SUB male connector

MT5000/4000 touch screen
 PLC RS-232 interface
 9-pin D-SUB male connector

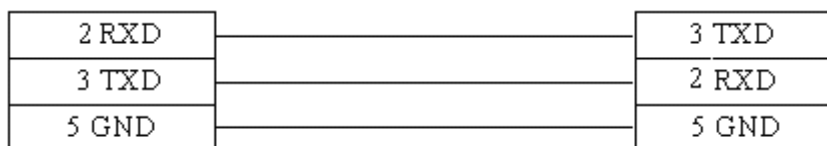

14.19 Baumuller Controller

Connection of Baumuller Controller with MT5000/4000 Touch Screen

◆ **EV5000 software setting:**

Item	Recommended Setting	Optional Setting	Precaution
PLC Type	BAUMULLER		
COM	RS485-4	RS232/RS485-4	
Data Bits	8	8	Must be the same as the COM port settings of the controller
Stop Bits	1	1	Must be the same as the COM port settings of the controller
Bits per Second	9600	9600/19200	Must be the same as the COM port settings of the controller
Parity	Even parity	Even parity	Must be the same as the COM port settings of the controller

◆ **Controller software setting:**

Refer to user manuals provided by BAUMULLER.

◆ **Operable address range:**

Bit/Word	PLC Address Type	Operable Range	Format	Description
bit	DB_BIT	0.00-255.0f	DDDH	Bit type
word	DB	0-255	DDD	Word type

Note: D indicates decimal notation, H indicates hexadecimal notation, the value range is 0 ~ F.

This is the address of the controller. When using the touch screen, pay attention to the rules for use. For details, refer to the description below:

BIT: for example, DB2_BIT, write DB2_BIT 0.F for the equipment address of the touch screen.

WORD: for example, DB2, write DB2 11 for the equipment address of the touch screen.

◆ **Detailed wiring diagram:**

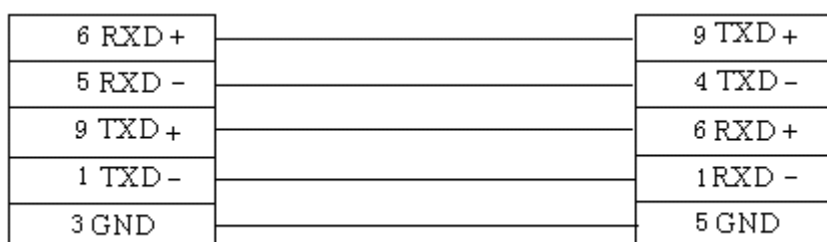

14.20 Kinco ECOSTEP CONTROLLER

Connection of Kinco ECOSTEP CONTROLLER with MT5000/4000 Touch Screen

◆ **EV5000 software setting:**

Item	Recommended Setting	Optional Setting	Precaution
PLC Type	ECOSTEP		
COM	RS 232		
Data Bits	8	8	Must be the same as the COM port settings of the controller
Stop Bits	1	1	Must be the same as the COM port settings of the controller

Bits per Second	9600	9600/19200	Must be the same as the COM port settings of the controller
Parity	None		Must be the same as the COM port settings of the controller

◆ **Controller software setting:**

Refer to the operation manuals provided by Kinco.

◆ **Operable address range:**

Bit/Word	PLC Address Type	Operable Range	Format	Description
Dword	20	Refer to operation instructions of Kinco		Word type
word	10	Refer to operation instructions of Kinco		Word type
word	8	Refer to operation instructions of Kinco		Word type

Note:

This is the address of the controller. When using the touch screen, pay attention to the rules of addressing. For details, refer to the description below:

Address type of the touch screen: Depends on the number of bits of the servo and the value can only be 20, 10 or 8.

Address of the touch screen: master address, and sub address

For example, on page 117 in the user manual for Kinco servo driver, the address is 2509, sub-address is 06, and the number of bits is 20. The addressing diagram of the touch screen is shown as follows:



◆ Detailed wiring diagram:

MT5000/4000 touch screen
 PLC RS-232 interface
 9-pin D-SUB male connector

Kinco
 Controller
 RS232 COM port

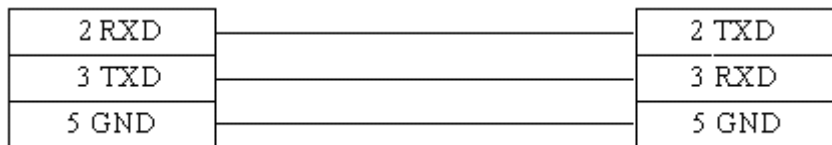

Chapter 15 Operation Instructions for EVManager

The EVManager management and configuration tool is shown in the following figure. This chapter introduces the usage of this tool.

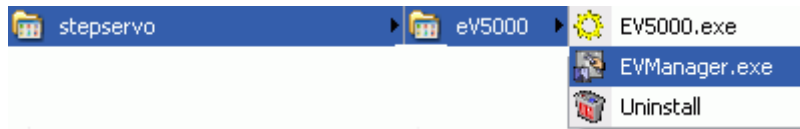

15.1 Introduction to EVManager

EVManager is the management and configuration tool for the EV5000 software. The EVManager tool consists of three operation processing modules: download, upload, and system operate.

The structural diagram is shown as follows:

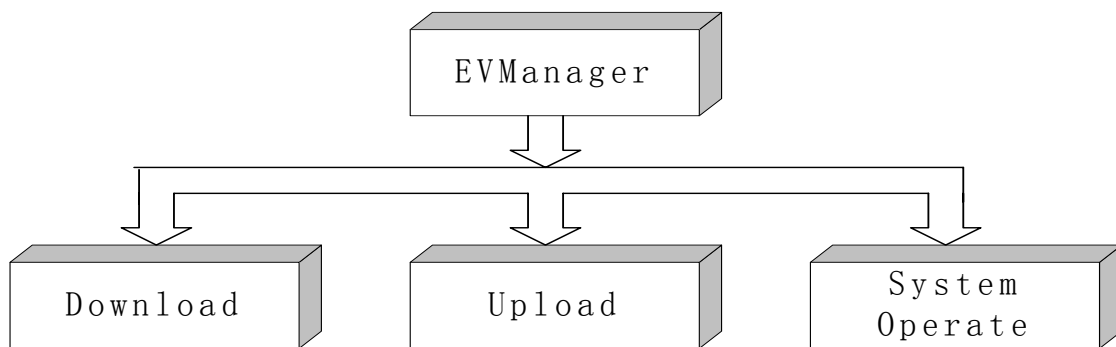

Select [**Start**]→[**Programs**]→[**stepservo**]→[**ev5000**]→[**EVManager**], the EVManager dialog box appears, as shown below:

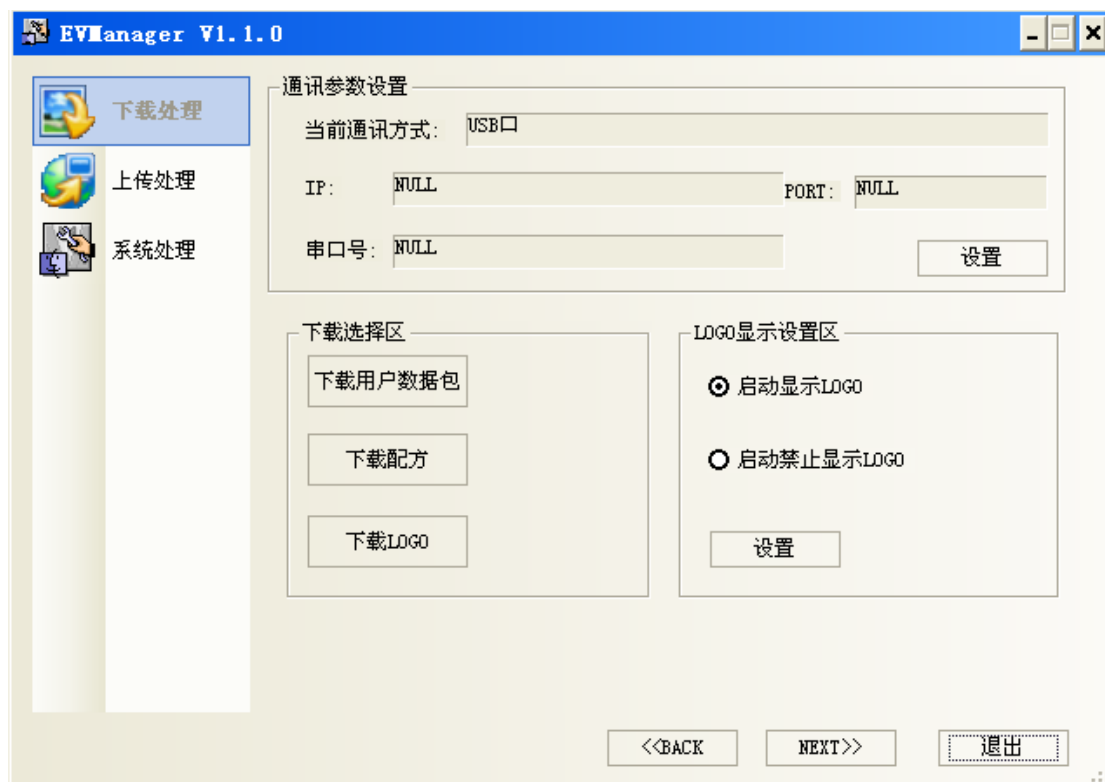

The section below will give a detailed description of different modules of the EVManager.

15.2 Download Operate

Download processing is mainly used for downloading files from a PC to the HMI panel.

Communication parameters must be properly set before downloading..

- **Communication parameter setting:** Select communication mode, the same as the **Tools→Setting** option in the configuration window. Please refer to Chapter 3 of this manual for downloading description.
- Selecting communication mode:
Click **Set**, the **Communication Parameter Setting** dialog box appears.
 - a. Download via Ethernet (Valid for MT5000 and MT4000E only)
In the setting dialogbox, select the Ethernet option, change the IP address to the IP address of the touch screen, do not modify the port number, and click **[OK]**.

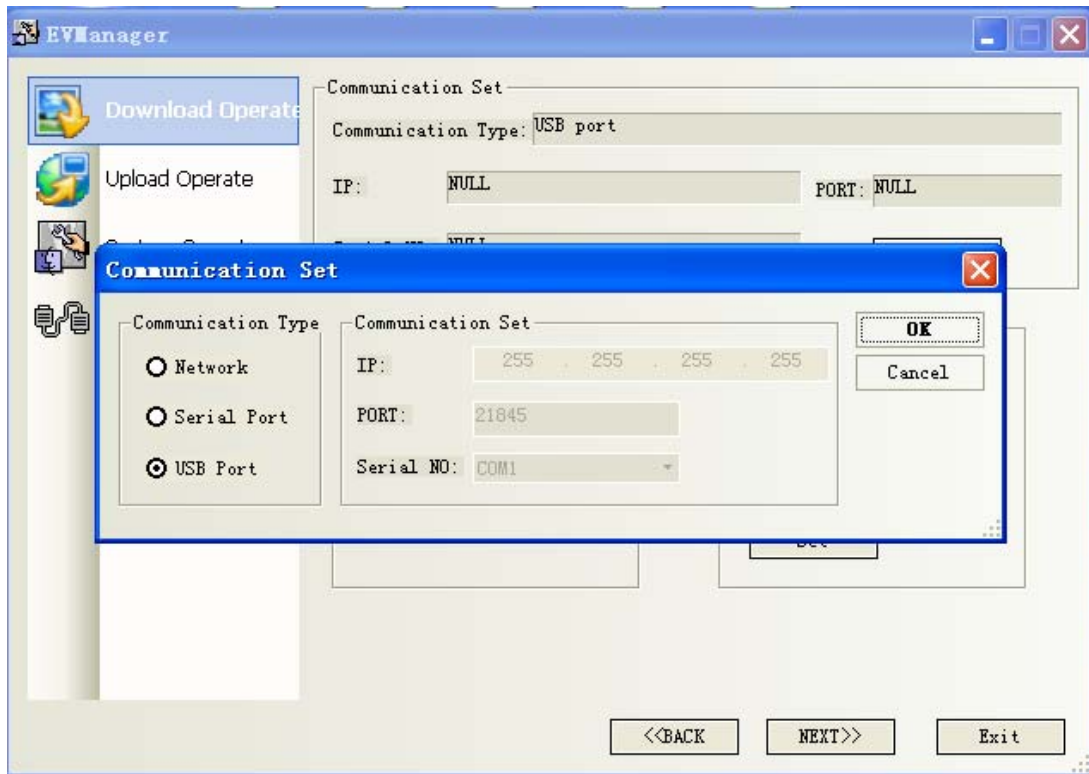

b. Download via serial port

Open the communication setting dialogbox. Select the **Serial Port** option, select the serial port number of your PC in the **Serial Port No.** drop-down list, click [OK].

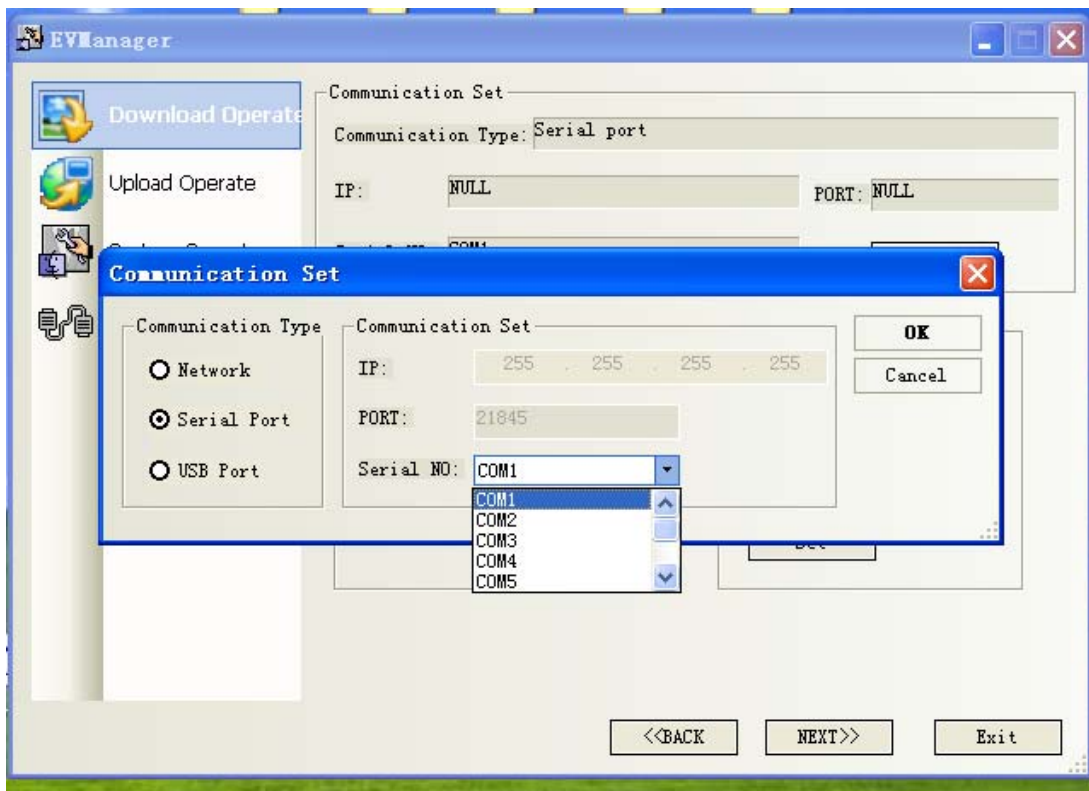

c. Download via USB port

The default downloading mode is USB. If you use the USB downloading mode, it is not necessary to set this option again.

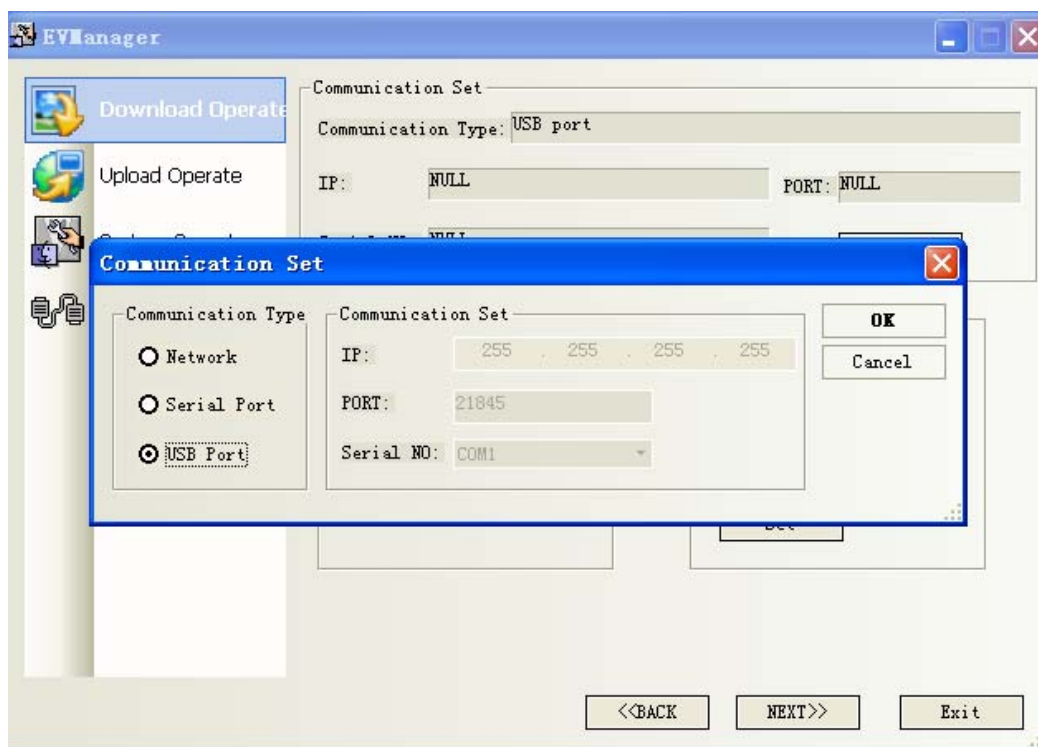

Download selecting section: The same as the downloading in the configuration edit program. Refer to the downloading described in Chapter 3.

Download User Data Files: Download compiled configuration project data files (*.pkg) to the touch panel. Click [Download User Data File]:

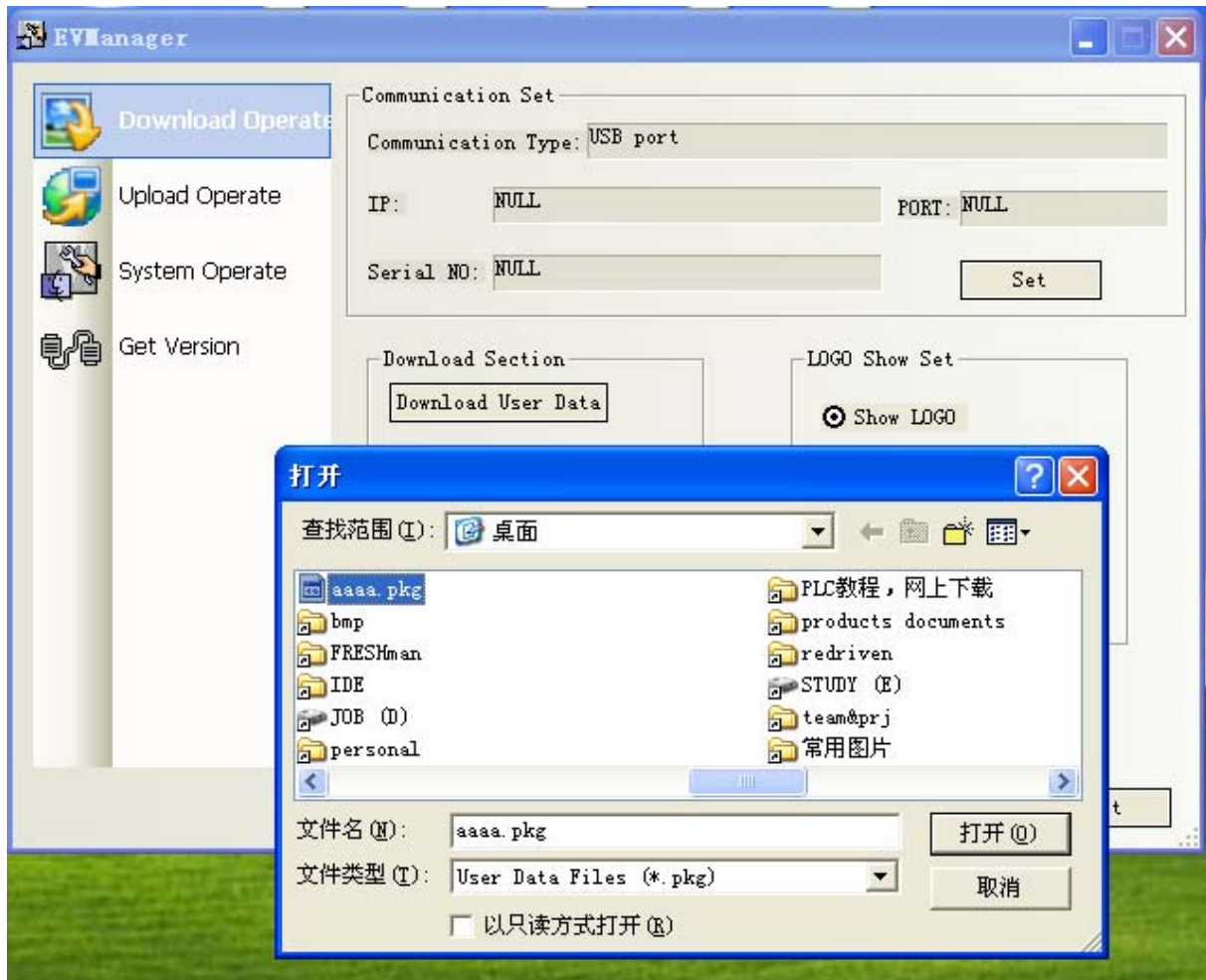

Select a compiled configuration project file (*.pkg) and click **Open**.

If your configuration project consists of multiple touch panels, as shown below:

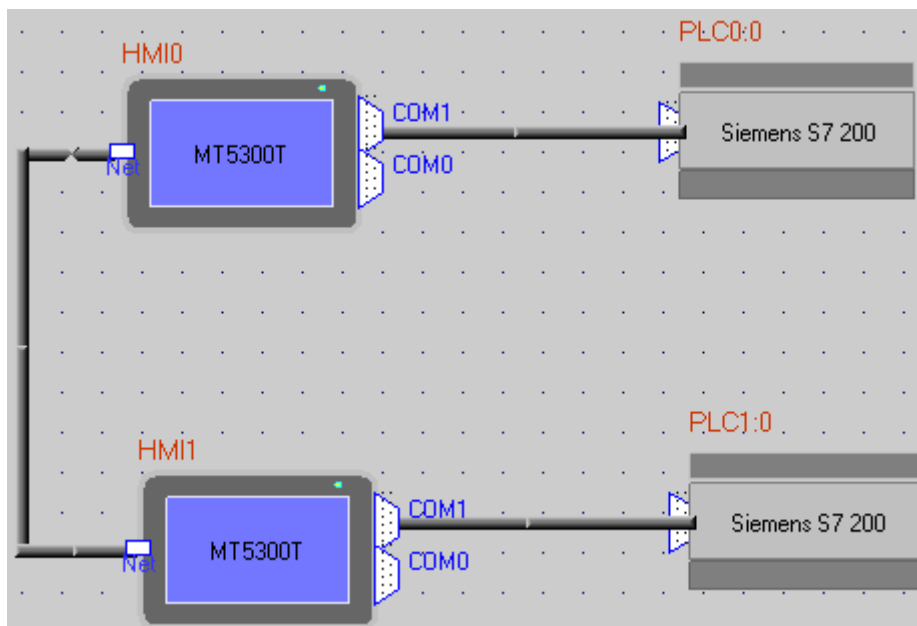

Select the HMI number corresponding to your target panel and click **Download**.

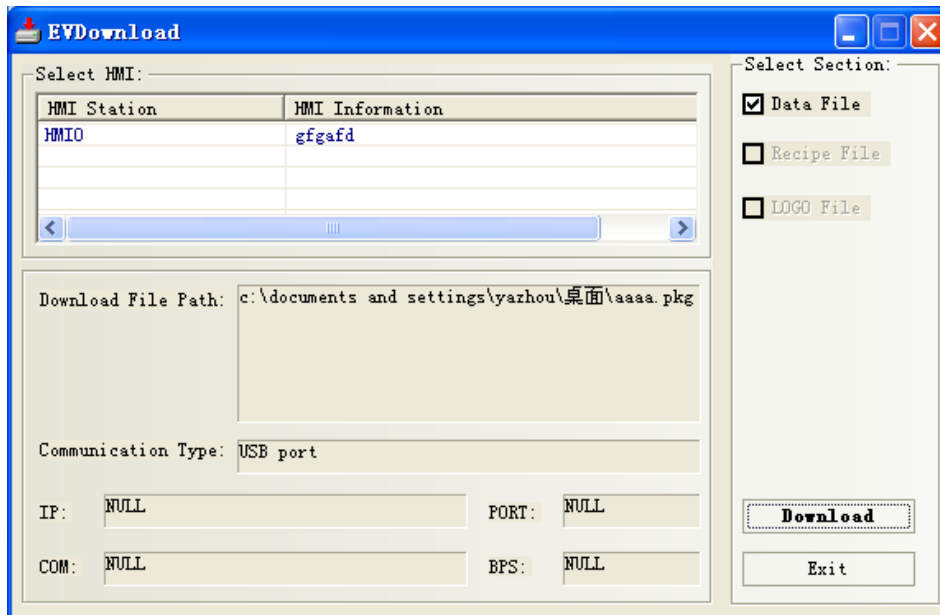

Downloading recipe:

Click **Download Recipe**, select a compiled recipe file (.rcp file), click **Open** to download the file.



Downloading LOGO

Click **Download Logo**, select a compiled configuration project in the “tar” folder, and then select the HMI.LOGO file in the HMI folder, and click **Open** to download the logo file.

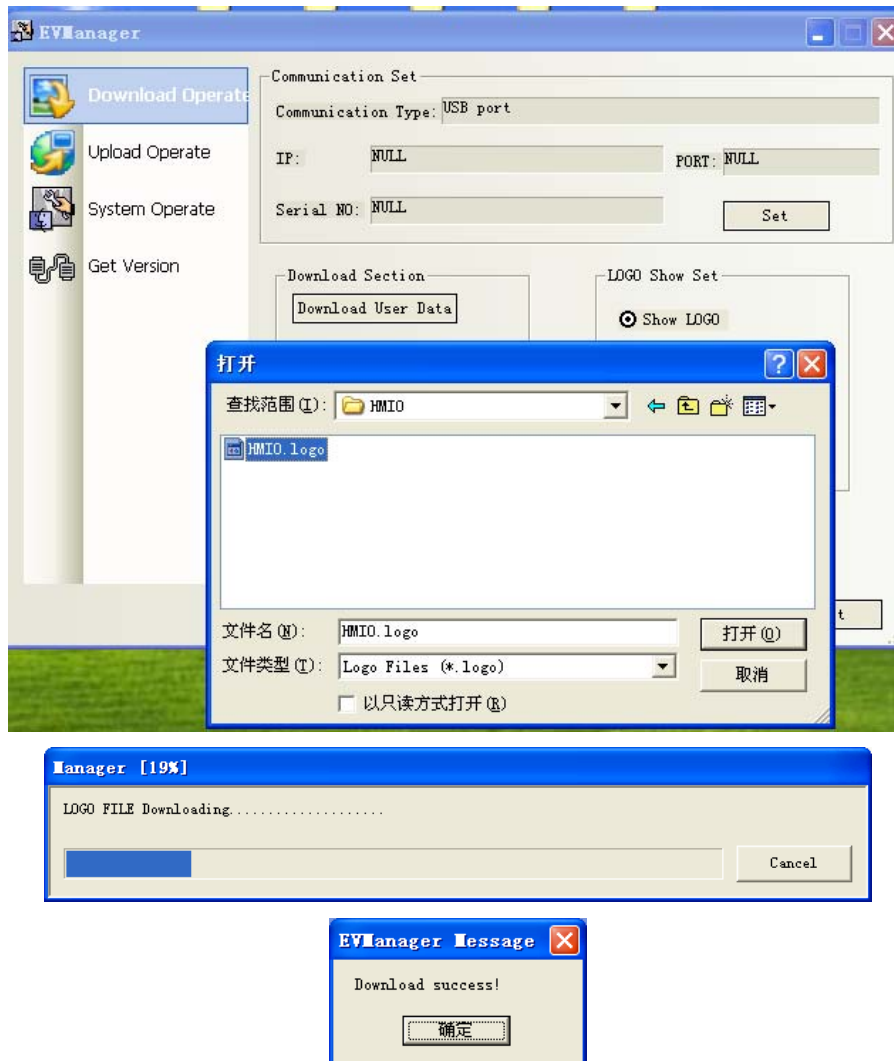

- **LOGO Show Set:** Determine whether the logo will be displayed during the power on of the panel. Changes will take effect after restarting the panel. Select **“Show logo”** and restart the panel, the logo will be displayed during power on; select **“UnShow logo”** and restart the panel, you will not see the logo during power on.

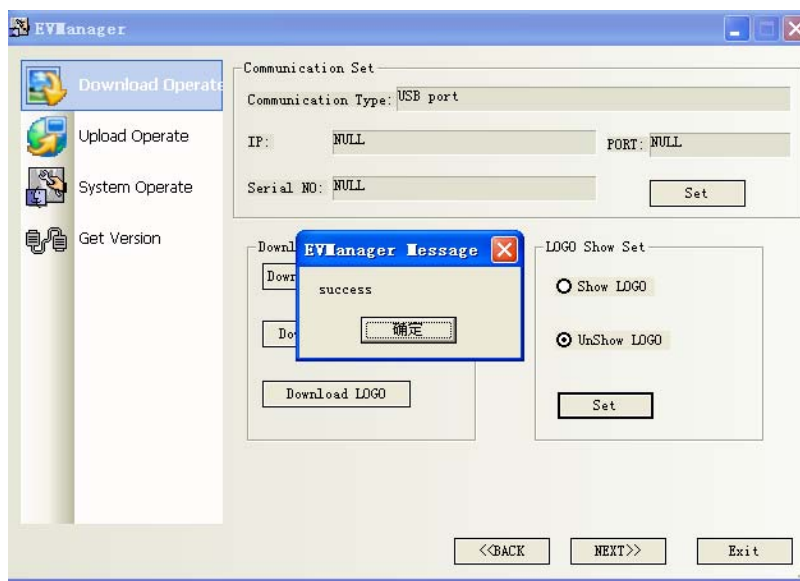

If the setting fails, an error message dialog box appears. Then, modify the settings of communication parameters again.

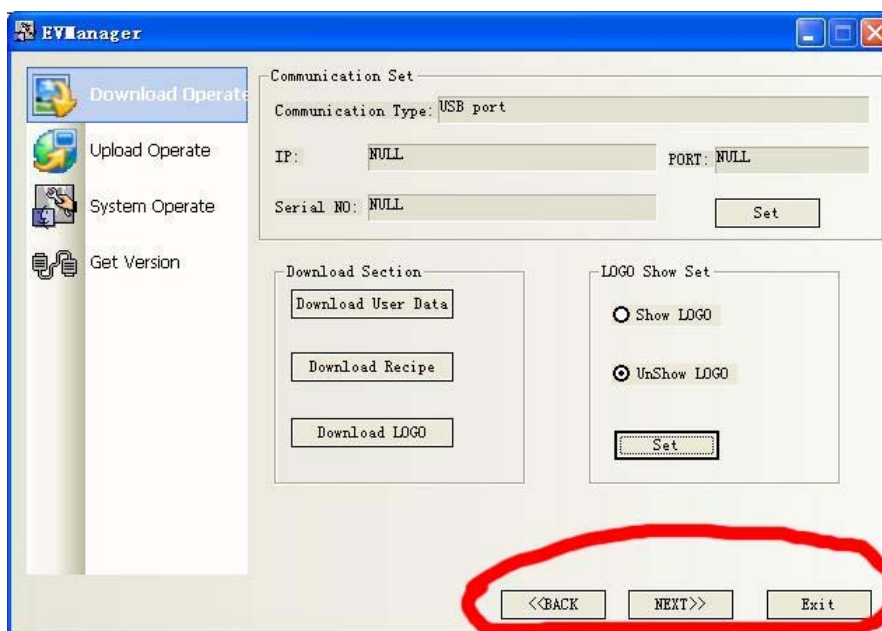

Click [BACK] and [NEXT] to switch between **Download Operate**, **Upload Operate** and **System Operate**.

15.3 Upload Operate

Upload processing is used to transfer data files from the touch screen to a PC.

Communication parameters must be properly set before uploading.

Communication parameter setting: the same as those described in downloading processing.

Upload section: in this area, the user can select the file type of uploading data

Upload user data: upload the data stored in the panel to the PC, the uploaded file will be saved as *.pkg file, the same as the user data file for downloading. Click "Upload user data" button, a dialog box appears and prompt the user to enter the HMI description, which can help the user

distinguish different panels.(Figure)

Select **Data File** (must be selected, the user can select logo file and recipe file also), click **[OK]**. Select a file saving path, enter a file name and click **Save**. The user data file is saved as *.pkg file. The **Upload Password** dialog box appears. Enter **the password** (this password can be set in the HMI attribution dialogbox, see chapter 7) and click **[OK]** to begin the uploading process.



Note: The default upload password is 888888 if it has not been set in the HMI attribution dialogbox, as the following figure shows:

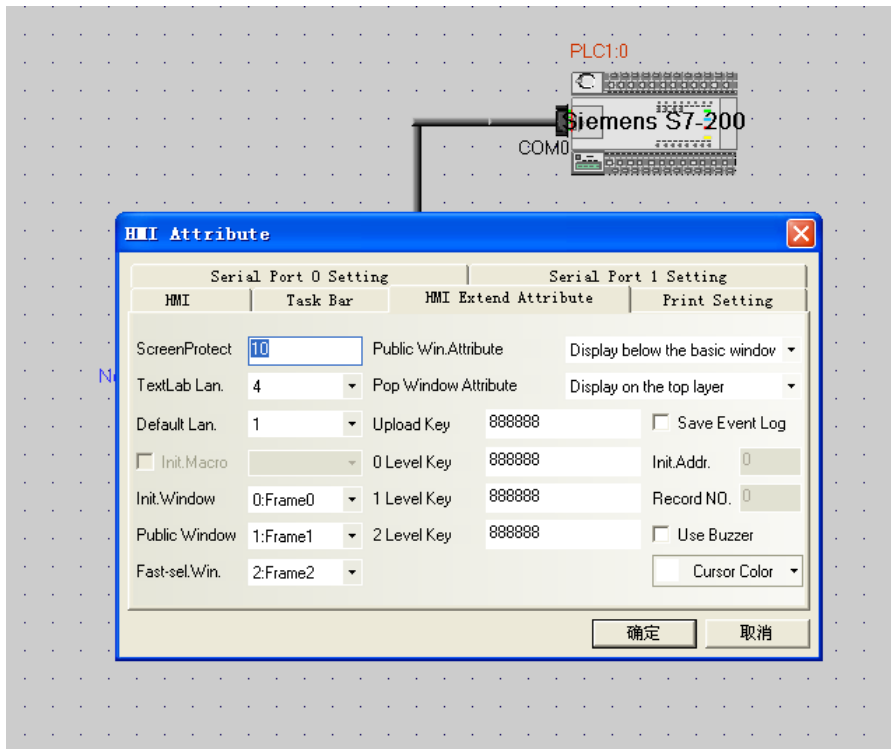

To upload the LOGO file or recipe file, select these two options. Logo and recipe file are uploaded and stored into the *.pkg file with the user data in this method.

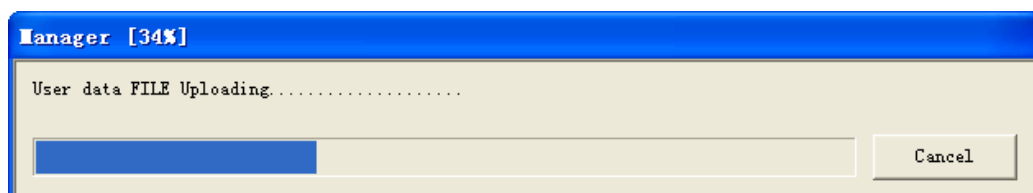
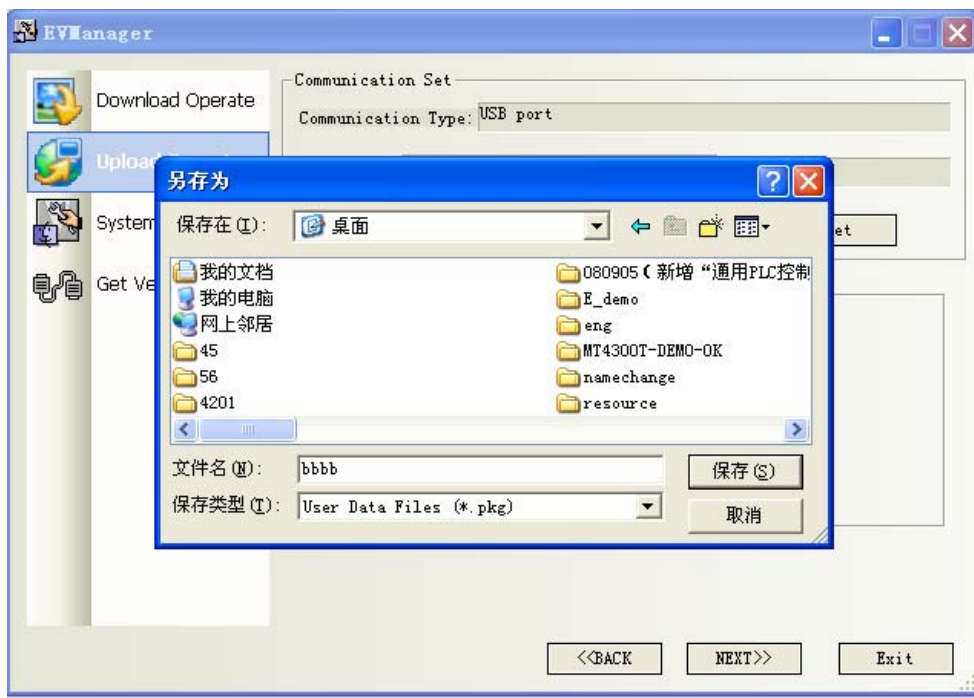
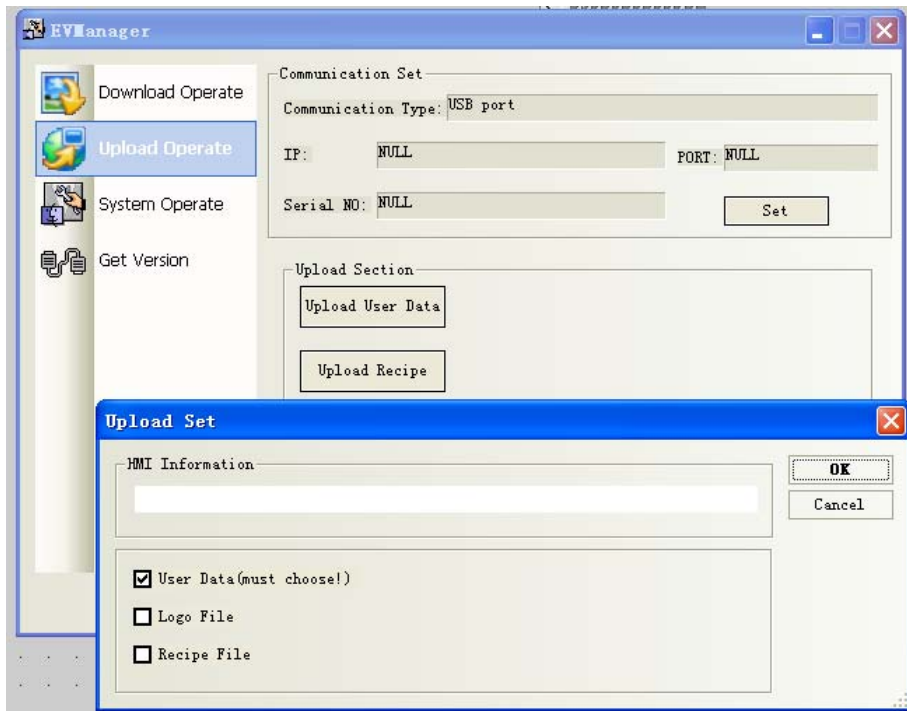



Click **Upload Recipe**, select a file saving path, enter a file name, and then click **Save**. Recipe file is uploaded and saved as a separated *.rcp file in this method.

Click **Upload LOGO**, select a file saving path, enter a file name, and then click **Save**. Logo file is uploaded and saved as a separated *.logo file in this method.

Note: The file name and file saving path of the uploaded file are determined by the user.

15.4 System Operate

System Operate is mainly used for refreshing the embedded OS files and testing.

- **Communication parameter setting:** the same as those described in download operate.
- **Get IP/PORT Information:** To obtain the IP and port number information of the touch panel (only MT5000 series support this function), click **Get** to display the IP address and port number of the target panel.

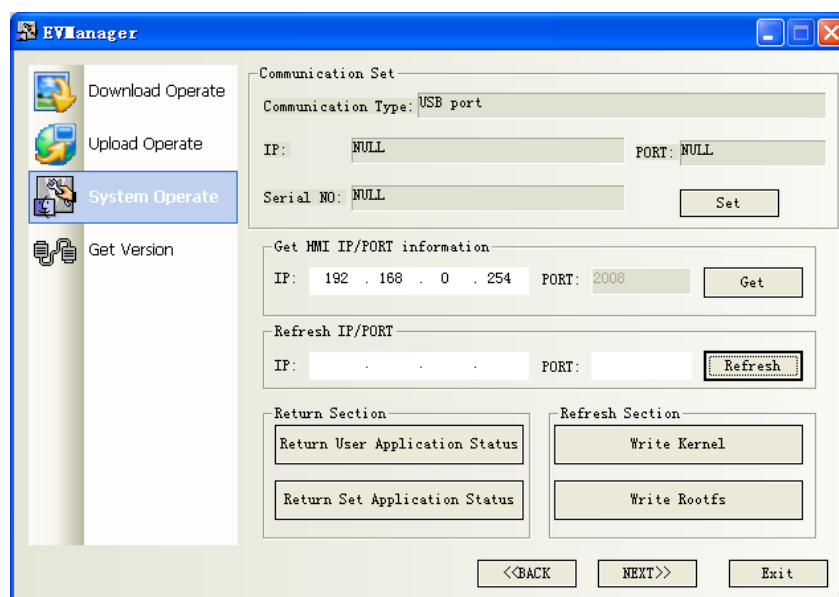

- **Update IP/PORT:** Modify the IP address and port number of the touch screen (Only MT5000 series support this function).

Enter an IP address, like 192.168.0.255. It is usually not required to modify the port number. Click **Update**, and the **Setting IP/PORT Successful** dialog box appears. Click **OK**, and the IP address of the target panel changes to 192.168.0.255.

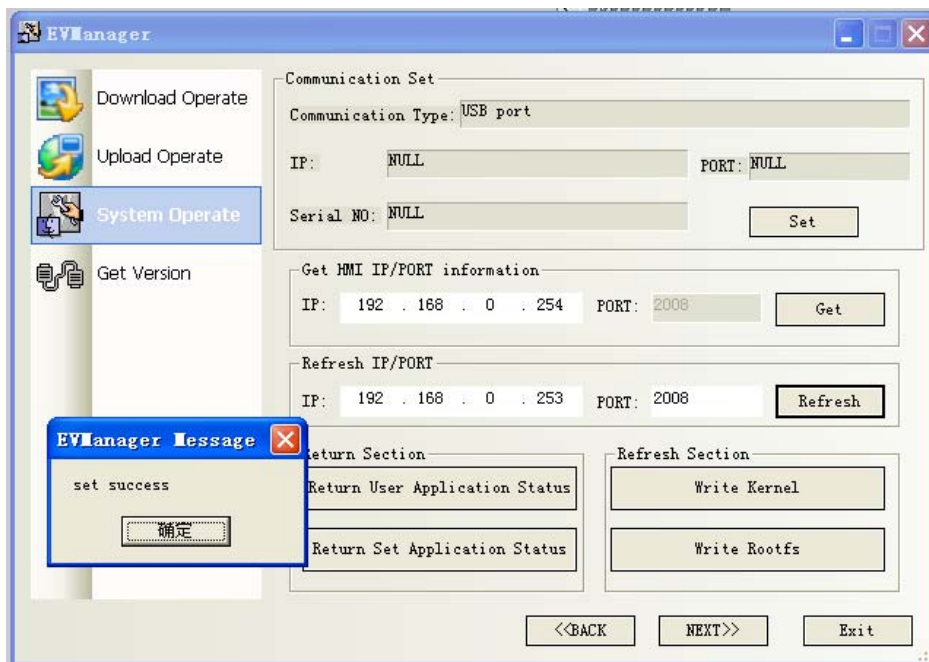

Click **Get**, and the IP address of the target screen is displayed as 192.168.0.255. It means the IP address is successfully modified.

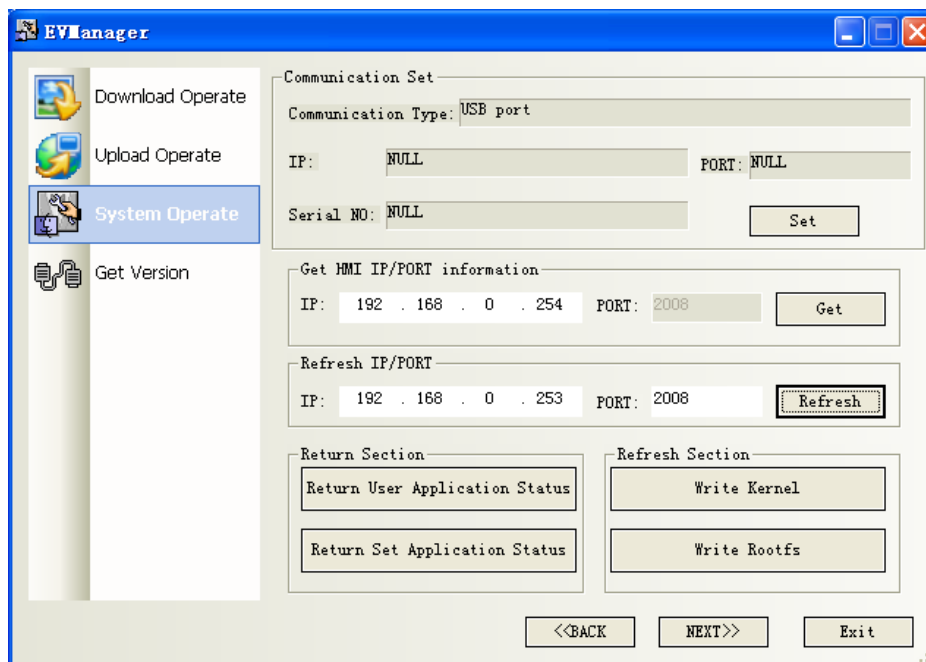

Note: To obtain IP/update IP address, the user can only select the communication mode of serial port or USB.

- **Jumping Selection Area:**

Jump to User Program Status: The target panel jumps to run the configuration program.

Jump to Setup Program Status: The target panel changes to the SETUP interface.

- **Update Operation Area:**

To update the kernel or file system of the embedded OS, the user can only select the

communication mode of serial port or network port (MT4000 series use serial port, and MT5000 series use serial port or network port). Before updating operation, switch the DIP switch 1 on the back of the target screen to **ON** and DIP switch 2 to **OFF**. After connecting and switching the DIP switch, click “Write Kernel” or “Write Rootfs” to conduct the update. The user can update any one part of the two and doesn’t need to update the two parts together all the time.



Note: After the updating OS kernel and root file system operation is conducted, the target screen restores to the factory default settings. Be cautious on such operation. This function is only available for advanced users.



Caution

Make sure the power supply of the panel is good during the OS kernel/root file system updating. Unpredictable errors may occur if power goes off during downloading. The updating operation is necessary only when the embedded OS is permanently damaged and it is strongly recommended that the user conduct this operation with the help of our technician.

Chapter 16 Use of Setup

The DIP switches on the back of the panel are shown in the following figure:

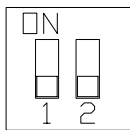

1 OFF 2 OFF

Normal working mode

1 ON 2 OFF

Firmware update and basic parameter setting mode

1 OFF 2 ON

Touch screen calibrate mode (available after updating kernel and file systems)

1 ON 2 ON

System setting (Adjusting brightness, contrast, date, and so on)

- **System Setting Mode:** In this mode, the touch screen will start a built-in system setting interface, where the user can set such parameters as IP address, brightness, contrast, and buzzer.
 - **Touch Screen Calibrate Mode:** In this mode when you touch the screen, the screen will display a “+” sign, through which you can calibrate the touch accuracy of the screen.
 - **Firmware Update and Basic Parameter Setting Mode:** In this mode the user can update firmware, set IP address, and perform other lower-level operations. In general, do not use this mode.
 - **Application (Online Operation) Mode:** This is the normal working mode of MT5000 series touch screens. The screen will display the starting picture of the downloaded project.
1. Set DIP switches 1 and 2 on the back of the touch screen to “ON” and press the [Reset] key.

The Setup interface for the eView MT4000 and MT5000 series appears.

Startup Window No.: Startup window, 0 by default. Modify the parameter only when necessary. After modification, re-download or reset the touch screen, and the modified window will appear.

Backlight Saver Time: Screen saver time, in the unit of minute. The default value is 10. No screen saver will be available when the value is set to 0. The time can be modified.

The **Setup** interface may not be able to display in full size in a single screen. In this case, click **[Next]** to enter the next page and click **[Back]** to return to the previous page.

Calibrate Time: Check whether the year, month, day, hour, minute, and second is the current time. If the time is not consistent with the current time, calibrate the time manually.

IP Address Setup: Modify the IP address and port number (PORT) of a target screen. It is necessary to reset the screen after modification.

Buzzer Disabled: Enable/disable the buzzer. After setting the option, it is necessary to reset the screen.

Adjust contrast (Contrast Up/Down) and brightness (Brightness Up/Down) to achieve the best visual effect.

Adjust contrast and brightness according to different models of HMIs:

5300L/5500L/4500L/4300L/4300S: Adjust contrast

5300S/5400S: Adjust contrast and brightness

5300T/5400T/5500T/5600T/5700T/4300T/4400T/4500T: Adjust brightness

4300C: No contrast or brightness adjustment function

2. Calibrate touch screen: Set DIP switch 1 to "OFF" and DIP switch 2 to "ON". Follow the "+" sign until you hear a click sound and the "+" sign disappears. Then, set DIP switch 1 and 2 to "OFF" and press **[Reset]**.

Chapter 17 Networking of MT5000 Series Touch Screens

17.1 Networking

17.1.1 Networking of One Touch Screen with Two PLCs of Any Brands

Communication mode of these two PLCs can be 232, 485 or 422.

It is shown in the figure below:

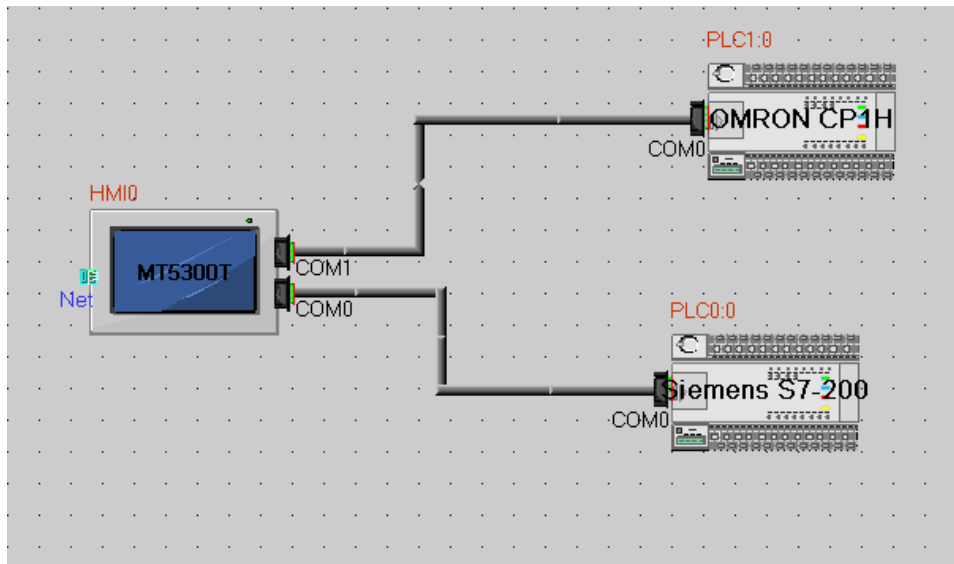

One MT5300T touch screen, with COM1 connected with a Siemens S7 200 PLC and COM0 connected with an OMRON PLC.



Caution:

1. Since COM1 is connected with a Siemens S7 200 PLC, COM1 must be set with the communication parameters of the Siemens S7 200 PLC. Since COM0 is connected with an OMRON PLC, COM0 must be set with the communication parameters of the OMRON PLC. Parameters on the right are default parameters and they will be created after the touch screen is connected with the PLC. Only an advanced user can modify these parameters; otherwise, it may cause communication errors.
2. The settings of these communication parameters depend on the internal communication parameters of the PLC, so they may vary in different situations.

Set the communication parameters of the Siemens S7 200 PLC as follows: Communication mode: RS485-2; "Bits per second": 9600; data bits: 8; parity check: even parity; stop bits: 1, as shown below:

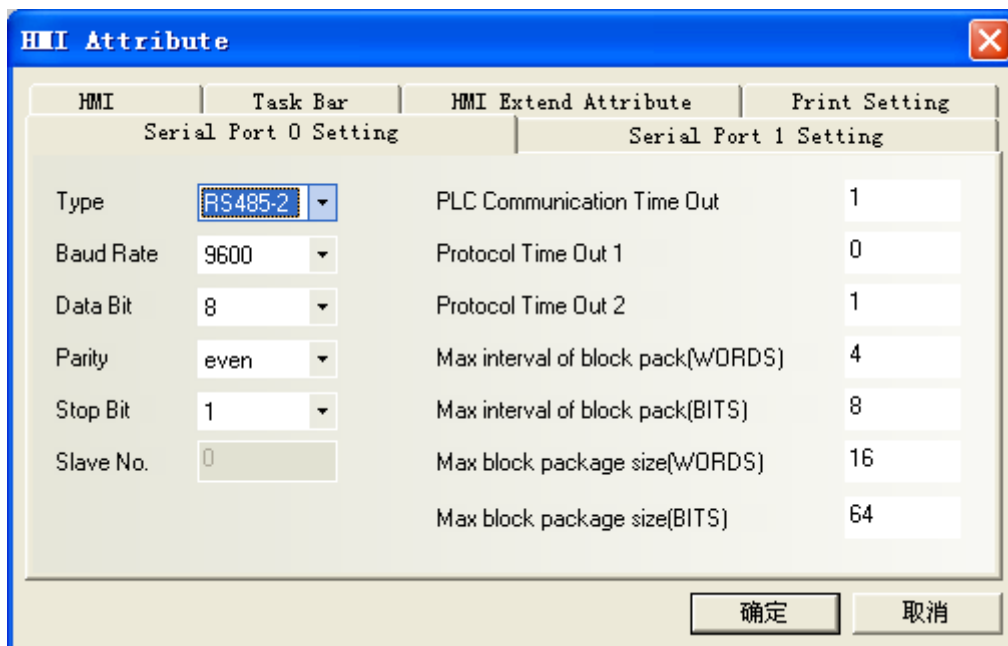

Double click the Siemens S7 200 PLC and set the PLC station No. to 2, as shown below:

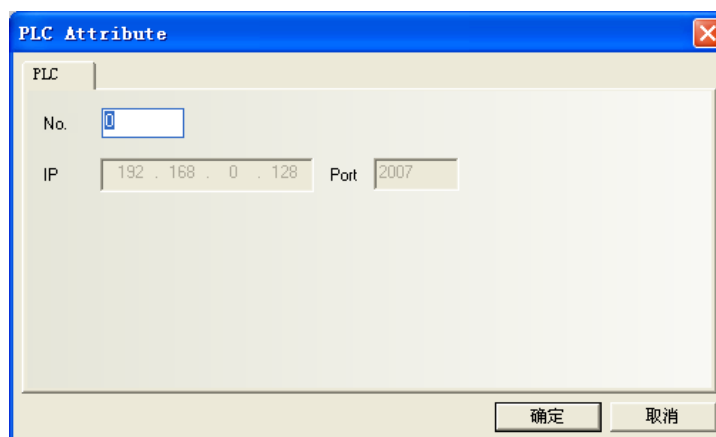

Set the communication parameters of the OMRON PLC (settings of COM0) as follows: Communication mode: RS232; "Bits per second": 9600; data bits: 7; parity check: even parity; stop bits: 2, as shown below:

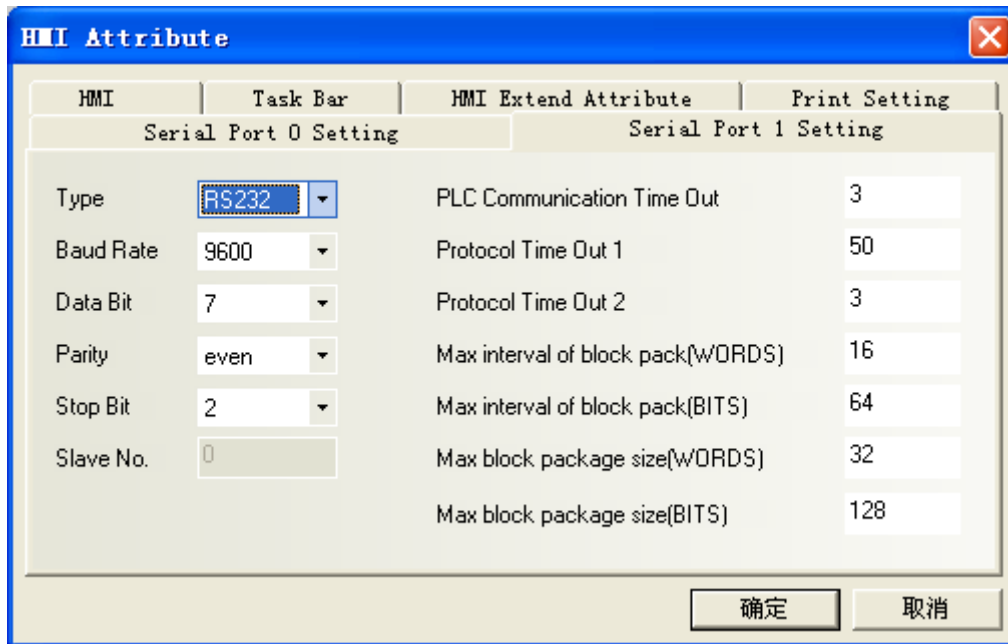

Double click the OMRON PLC and set the PLC station No. to the default value 0, as shown below:

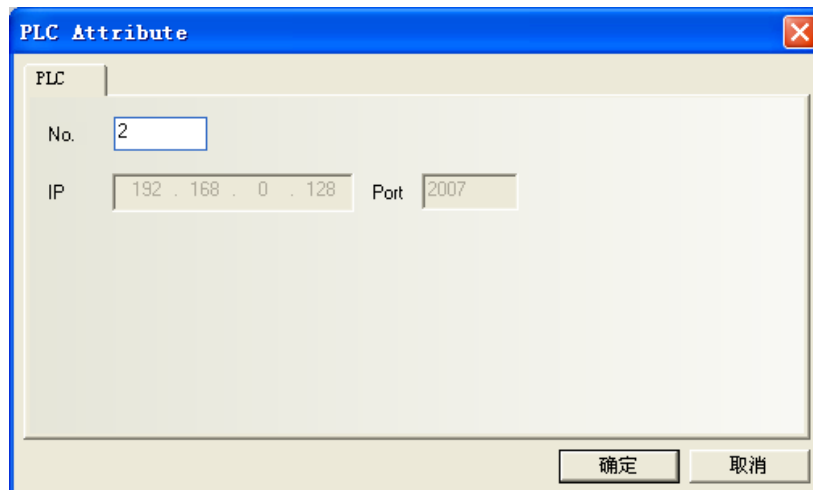

Right click on HMI0 and select the **(Edit Configuration)** menu to enter configuration window 0, as shown below:

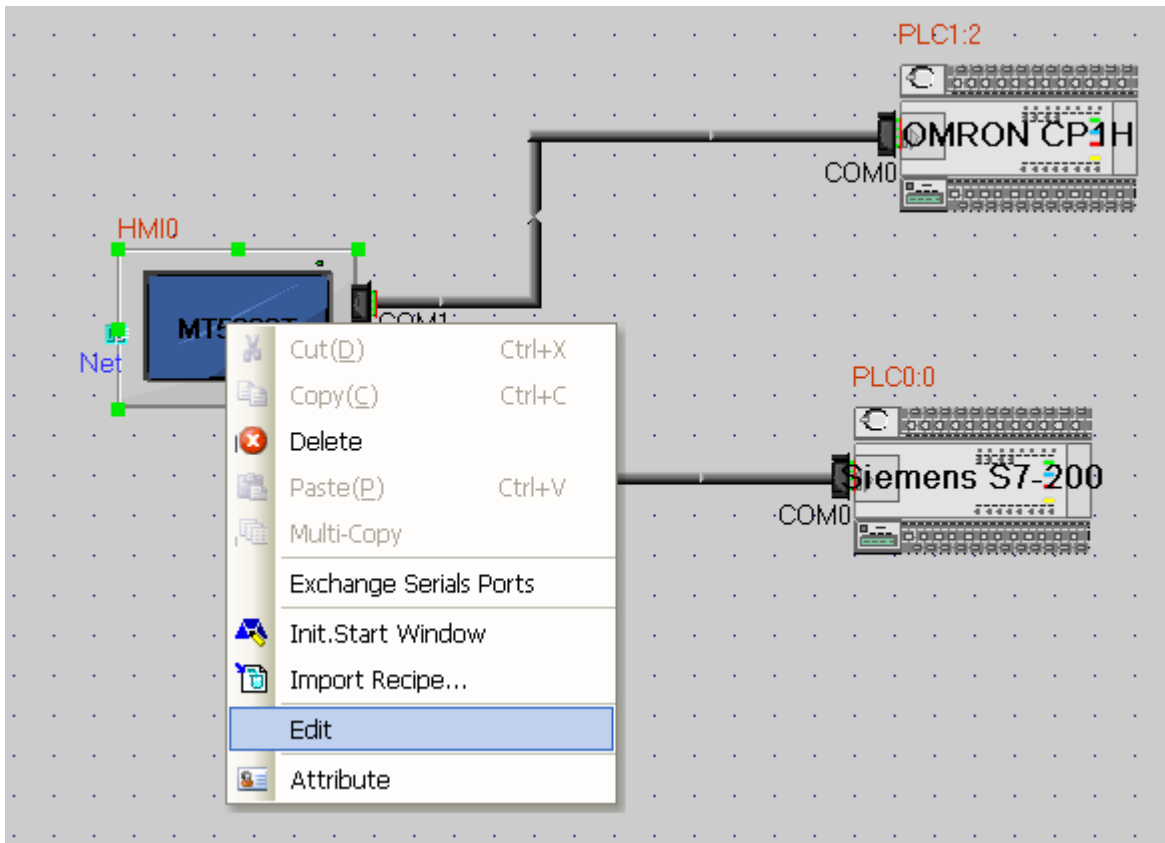

Editing configuration:

Place a bit setting component, set the PLC No. to 0, and select S7 200 address for address type.

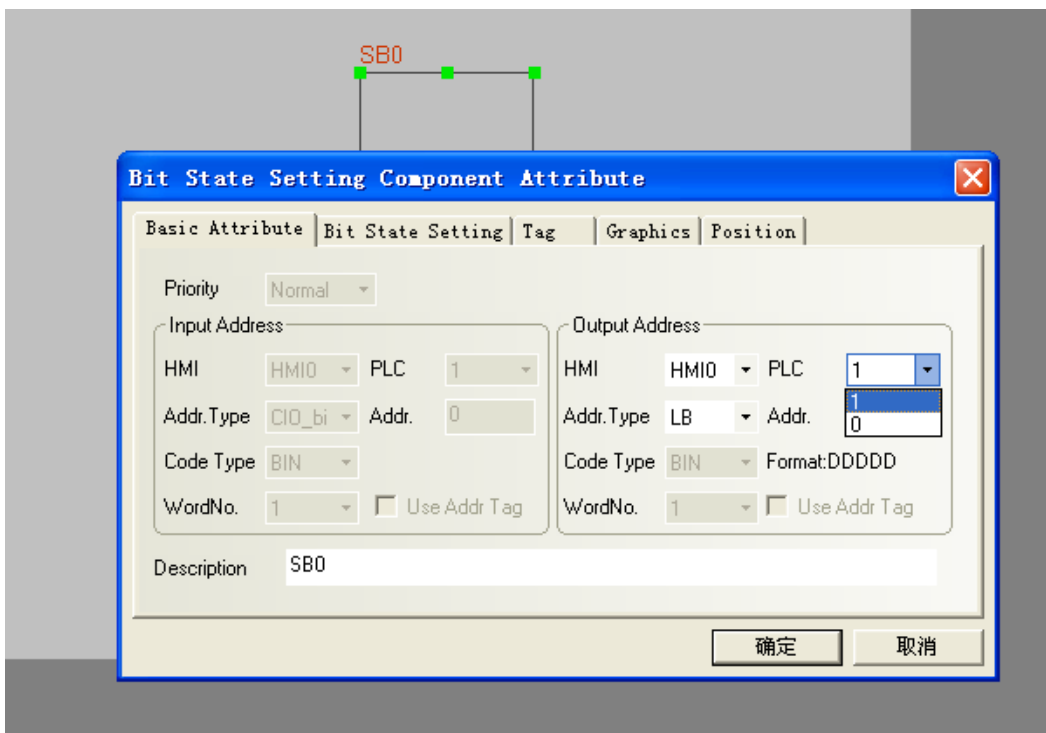

Place a bit setting component, set the PLC No. to 1, and select OMRON address for address type.

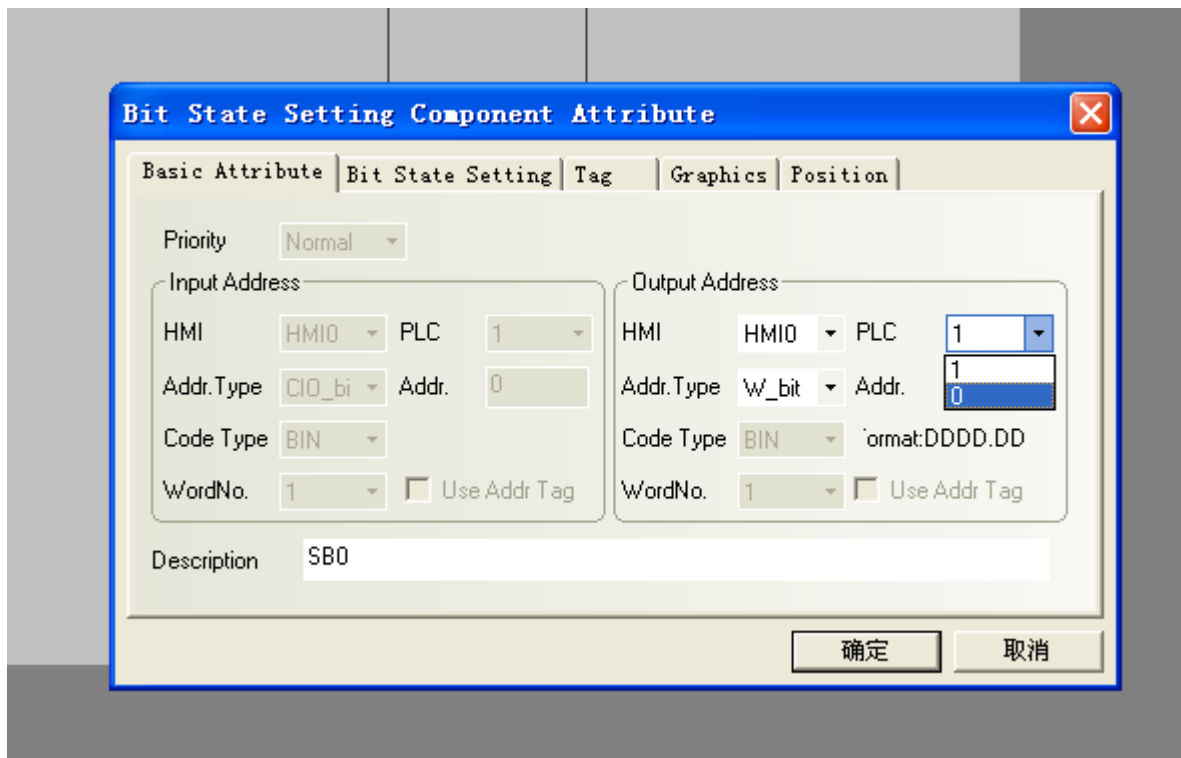

To set other components, select corresponding PLC numbers.

17.1.2 Networking of One Touch Screen with Multiple PLCs



Caution:

1. When a touch screen is connected with multiple PLCs, the communication mode can only be RS-485 instead of RS-232.
2. The same COM port must be connected with same PLCs or the PLCs supporting the same protocol.

As shown in the figure below, COM1 is connected with 2 Siemens S7 200 PLCs, and COM0 is connected with 3 MODBUS RTU PLCs, or 3 PLCs supporting the MODBUS RTU protocol (for example: LG MODBUS RTU, EMERSON MODBUS RTU, Schneider MODBUS RTU). However, during configuration, these three PLCs must select MODBUS RTU. In actual connection, the user can use PLCs supporting the MODBUS RTU protocol.

3. Setting of communication parameters: The same COM port shall have same settings no matter how many PLCs it is connected to.

Double click each PLC and modify it to be the corresponding PLC station No. As shown in the figure below: station numbers of the Siemens S7 200 PLCs are respectively 0 and 2, while the station numbers of the MODBUS RTU PLCs are respectively 1, 2 and 3.

4. Setting of PLC components: Select corresponding PLC number.

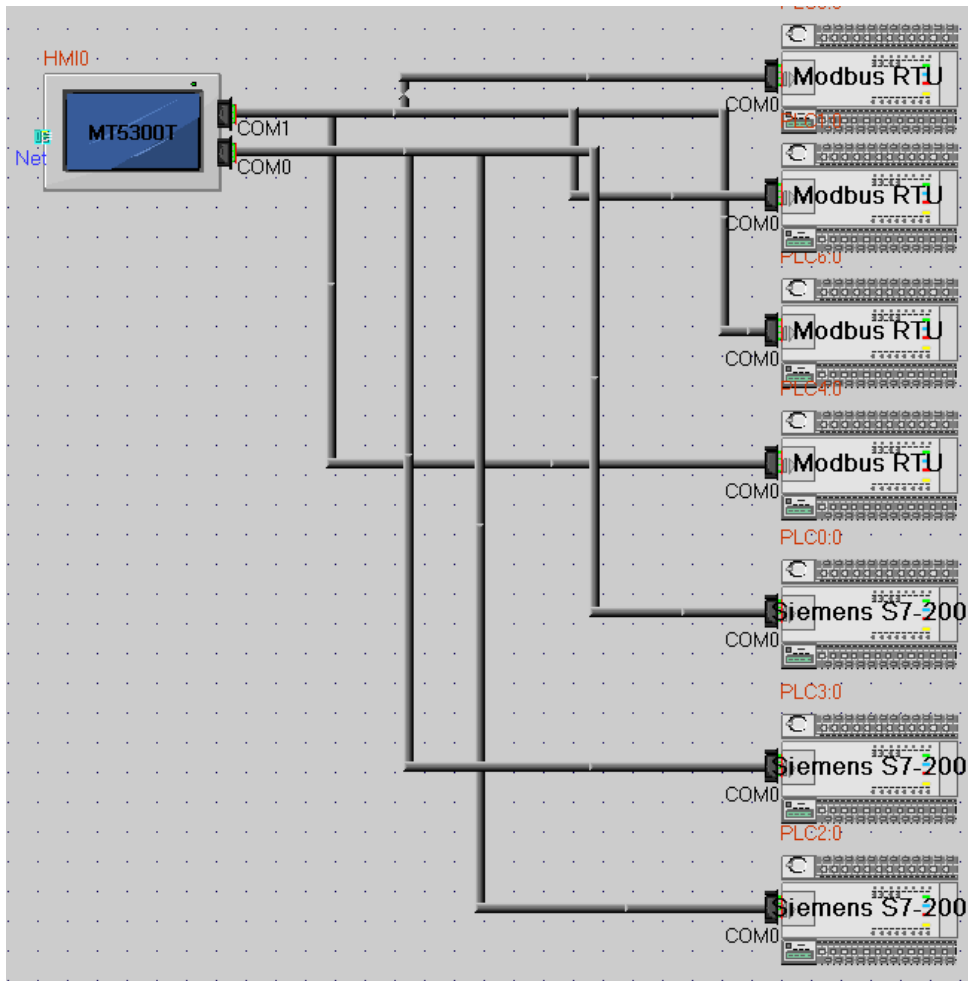

17.1.3 Networking of Multiple Touch Screens with One PLC



Caution:

1. Different types of touch screens can be connected with each other.
2. Different touch screens are connected with each other through the Ethernet.

As shown in the figure below, lead an Ethernet cable from **Communication Connection**.

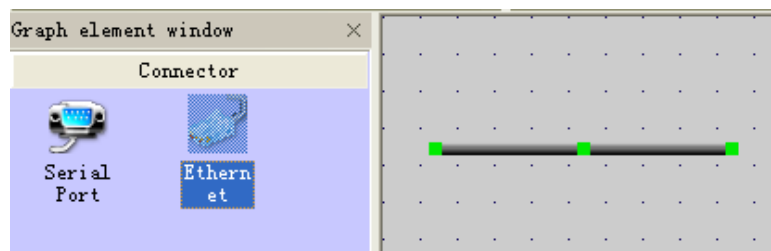

Connect the Ethernet cable to the **Net** interface of the touch screen and connect two touch screens together in this way.

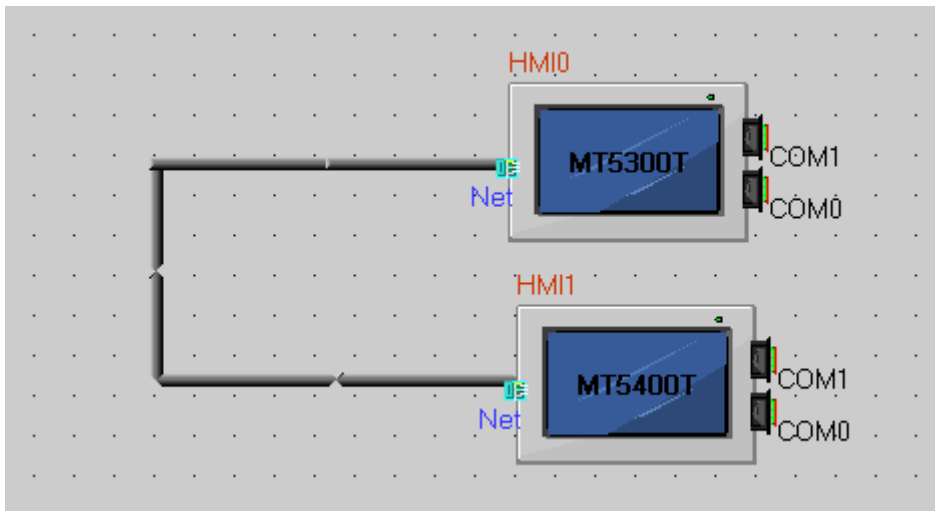

Lead another Ethernet cable from **Communication Connection** and connect it to the Net interface of a touch screen. In this way, three touch screens are connected, as shown in the figure below:

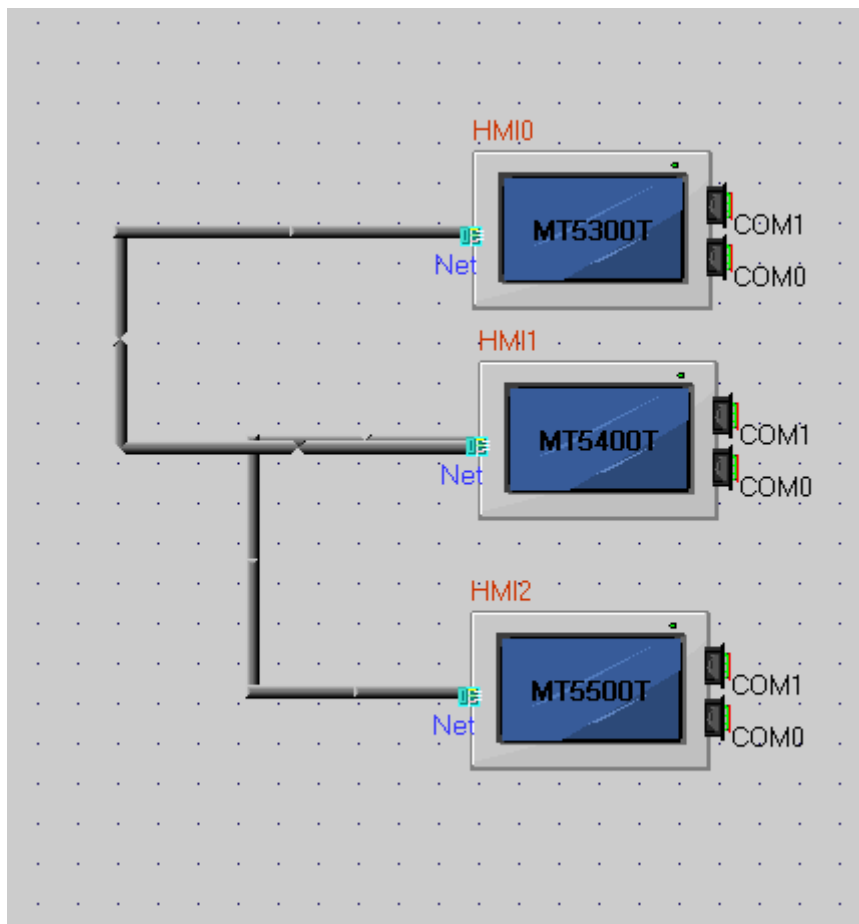

Connect the PLC with the corresponding touch screen, as shown in the figure below:

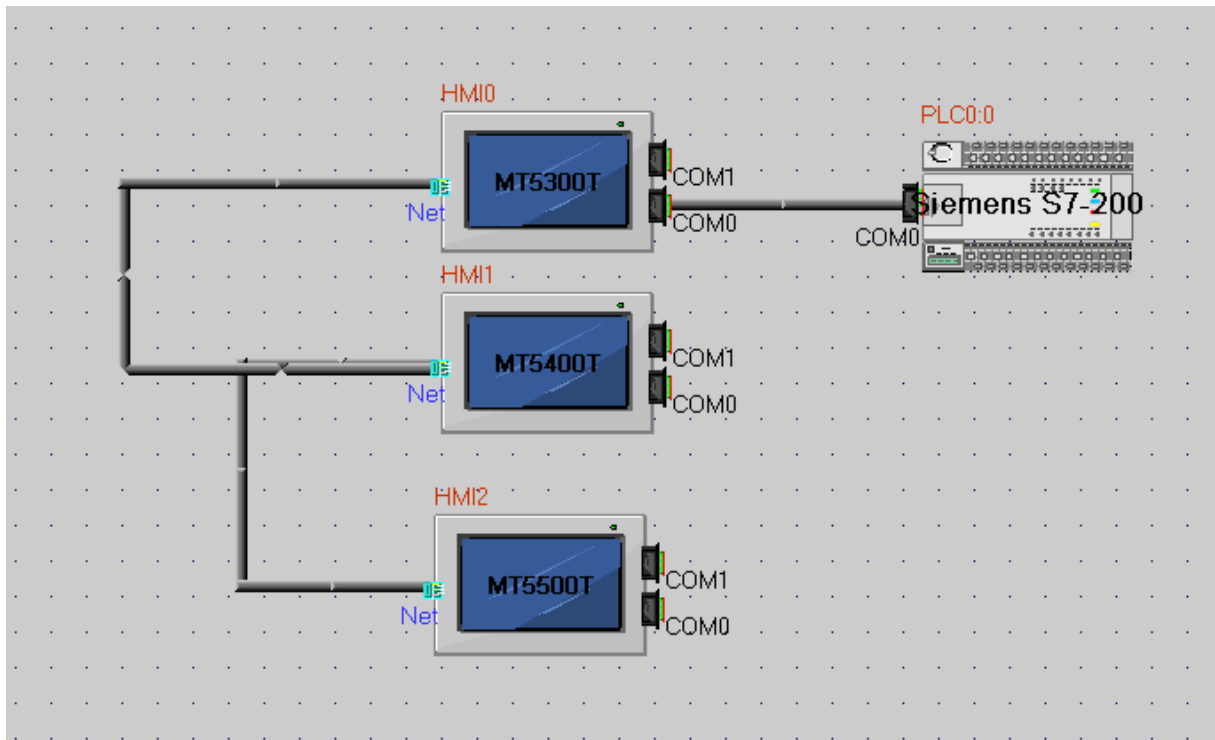

 **Caution:** Edit configuration only on the touch screen connected with the PLC. When editing PLC components, do not select the touch screen number and the PLC number, as shown in the figure below:

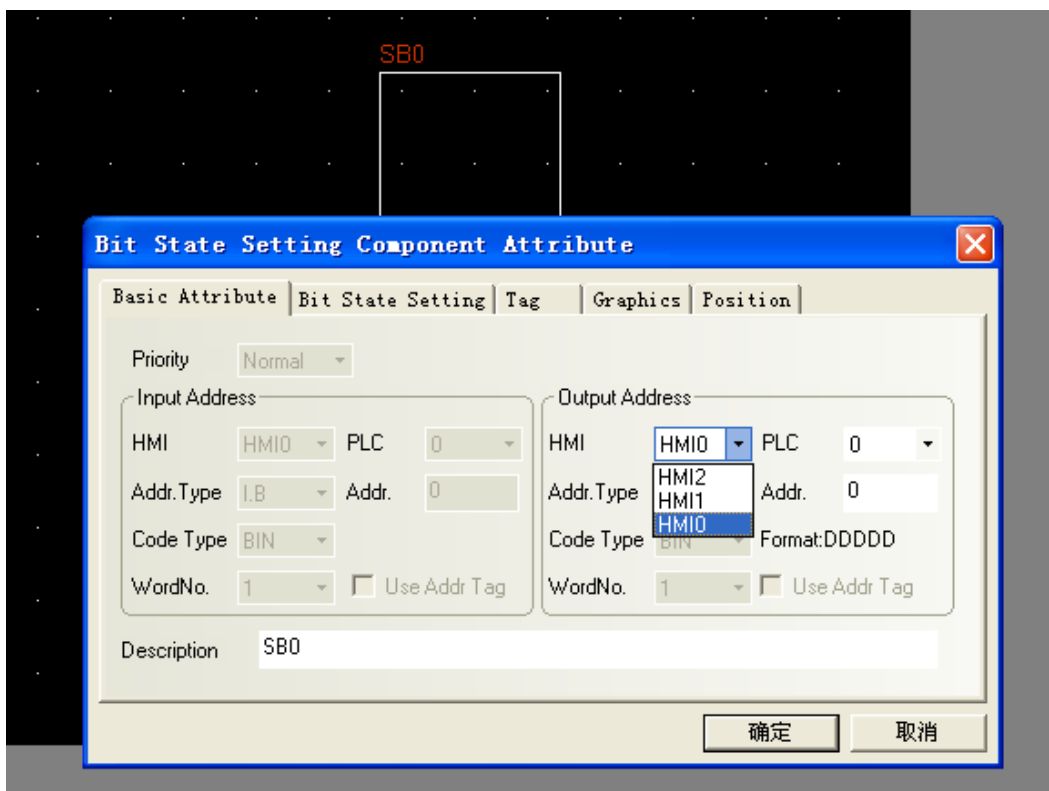

Compile the component, select the **(Offline Simulation)** mode, select the corresponding touch screen number, and click **(Simulate)** to perform offline simulation, as shown in the figure below:

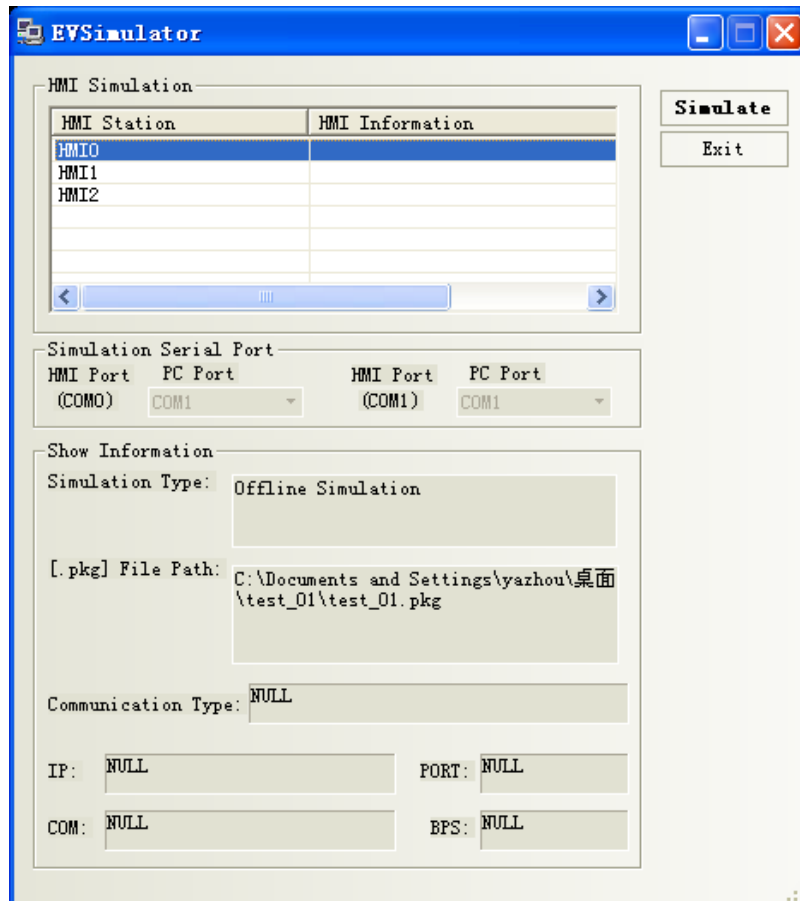

Select corresponding touch screen number and click **Download** to perform download operation.

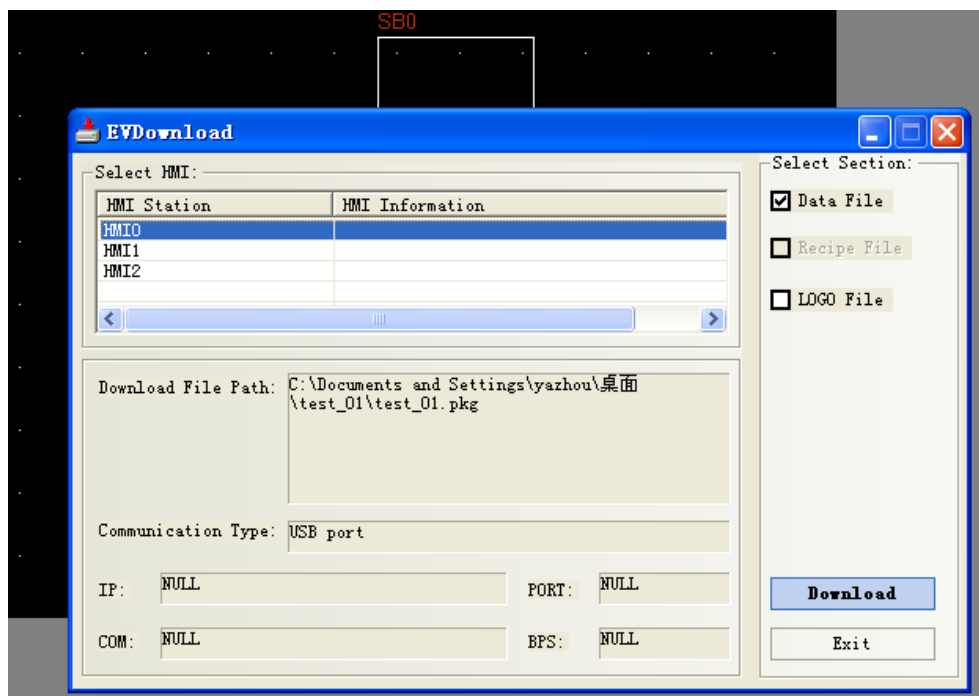

Downloading between different touch screens must be conducted via a PC. Firstly, upload from a touch screen to the PC and then download from the PC to another touch screen.

17.1.4 Networking of Multiple Touch Screens with Multiple PLCs

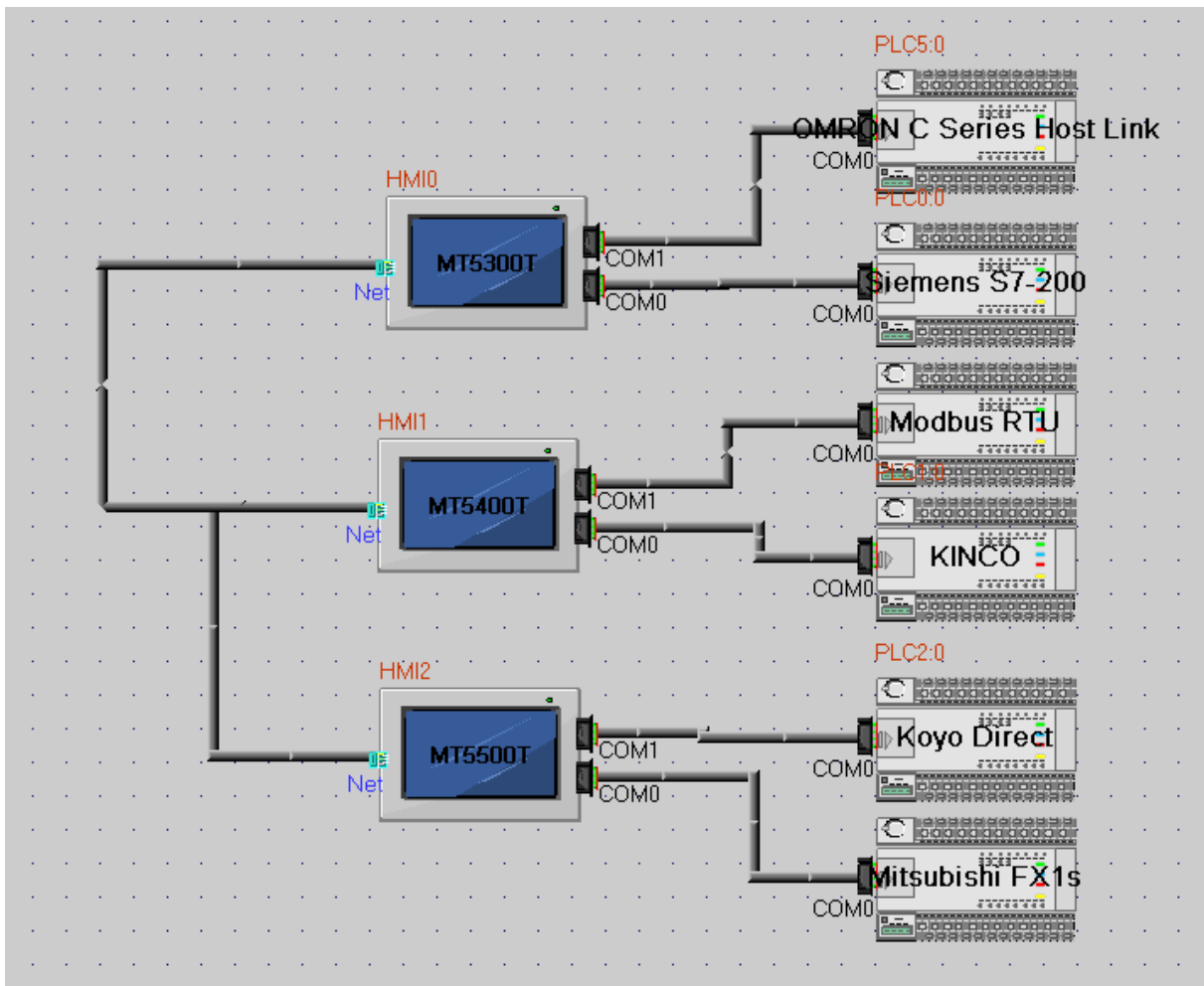

Caution: Data reading and modification operations can be performed between different touch screens.

Configurations can be edited between different touch screens. When editing PLC components, select corresponding touch screen number and PLC number, as shown in the figure below:

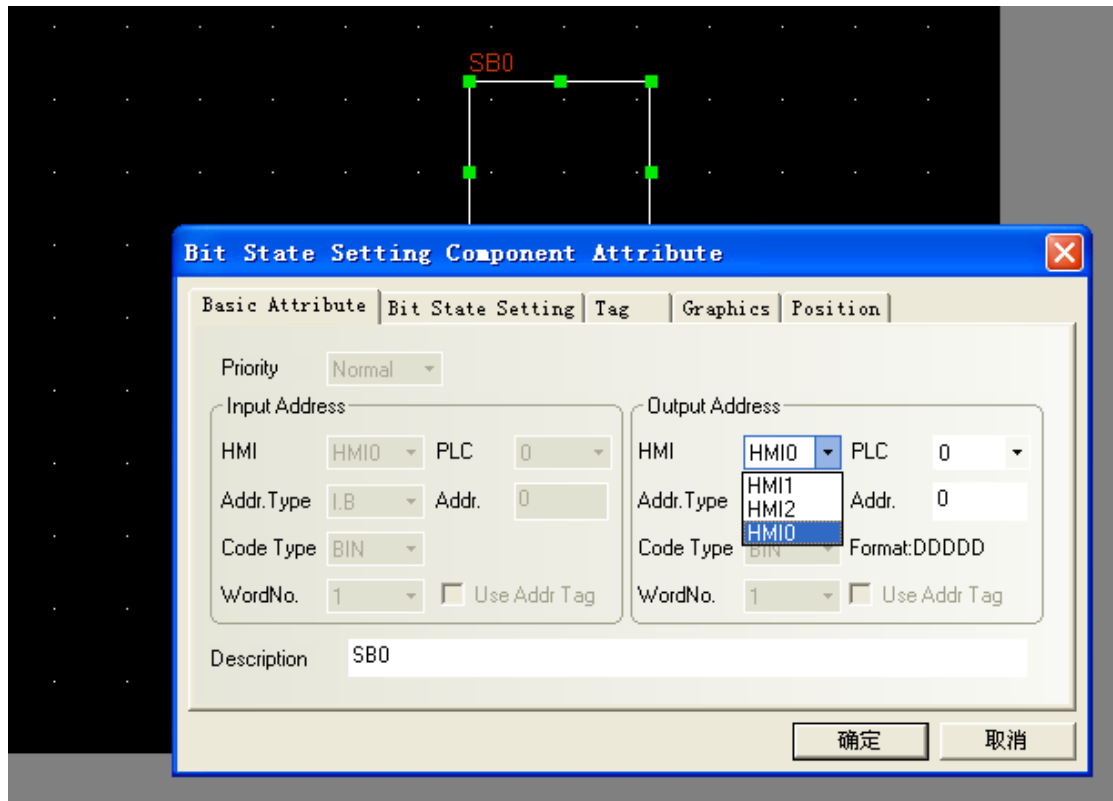

Compile the component, select the **(Offline Simulation)** mode, select the corresponding touch screen number, and click **(Simulate)** to perform offline simulation.

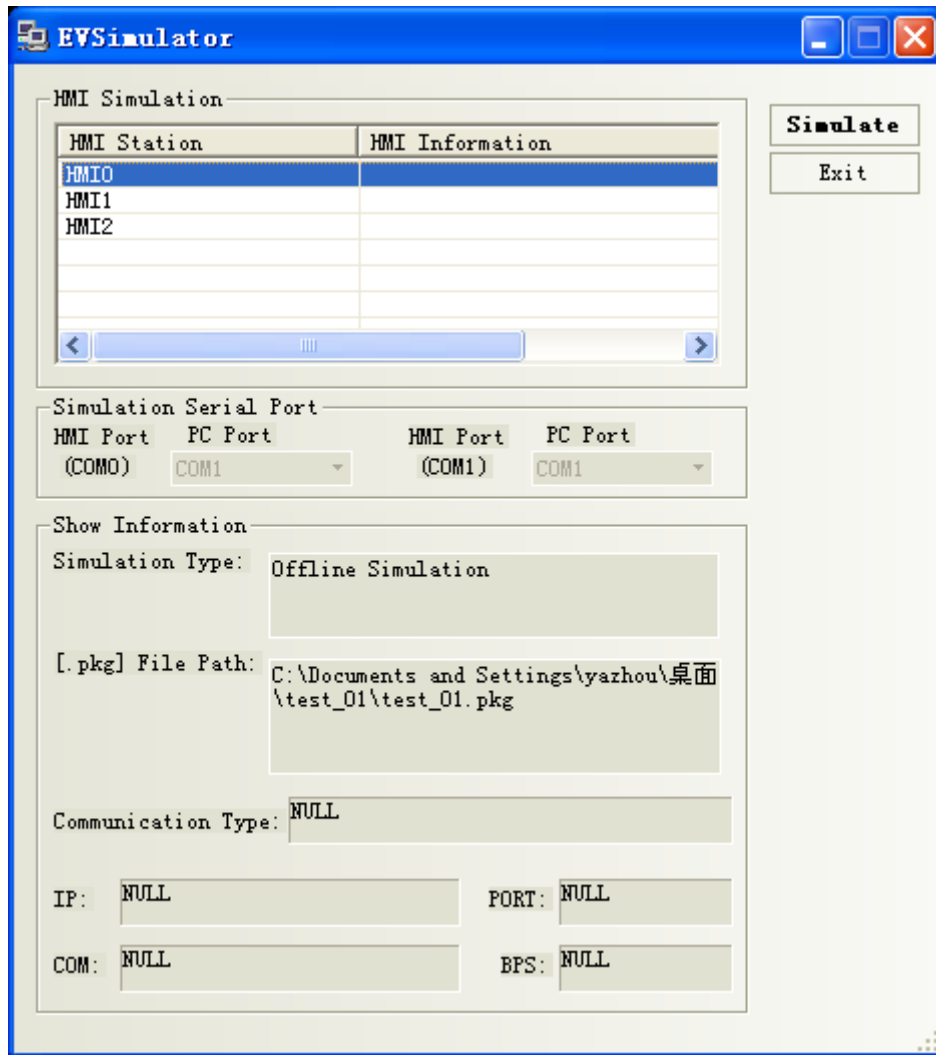

Select the corresponding touch screen number and click **(Download)** to perform download operation.

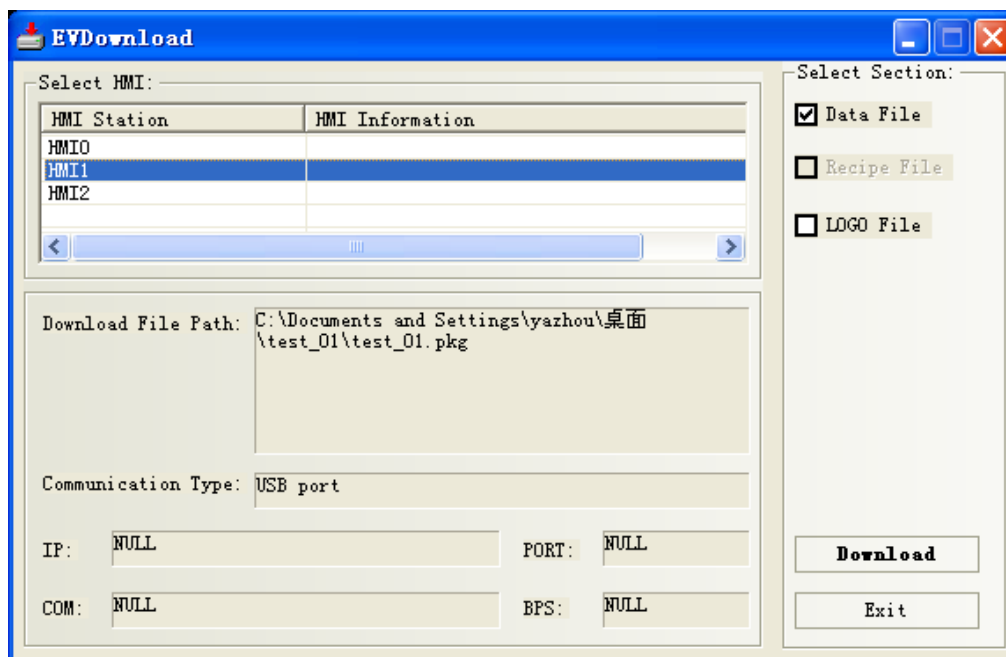

17.2 Mutual Download Between Different Touch Screens

Downloading between different touch screens must be conducted via a PC. Firstly, upload from a touch screen to the PC and then download from the PC to another touch screen. For upload methods, refer to related descriptions in Chapter 15.



Caution: Only MT5000 series support networking function.

Appendix I System Messages

MT5000/4000 System Messages Table

Messages	Description
PLC no response: cc-pp-d	PLC no response: Meaning of the three groups of digits followed the message: HMI No.—PLC station No.— Serial port No.
PLC response error	PLC response error: PLC responds an unexpected message, which may be caused by read or write command. Check whether the PLC is correctly configured.
Socket Connect Error	Network connection error: Check whether the IP address, port number, and PLC communication parameters are correctly configured.
Socket Comm Error	Network communication error: Please contact us.
Macro Code Error: xxxx (macro No.)	Programming error with macros, so it encounters infinite loop or execution timeout. Please check the programming code of the macro. The number followed is the macro number.
System error	System error, an internal error with the touch screen
Print error	Print error, not connected with the printer or print error
Server Error	Server error

Appendix II Troubleshooting

The following is the method for removing the “PLC no response” and “PLC response error” fault.

The flow chart is shown below:

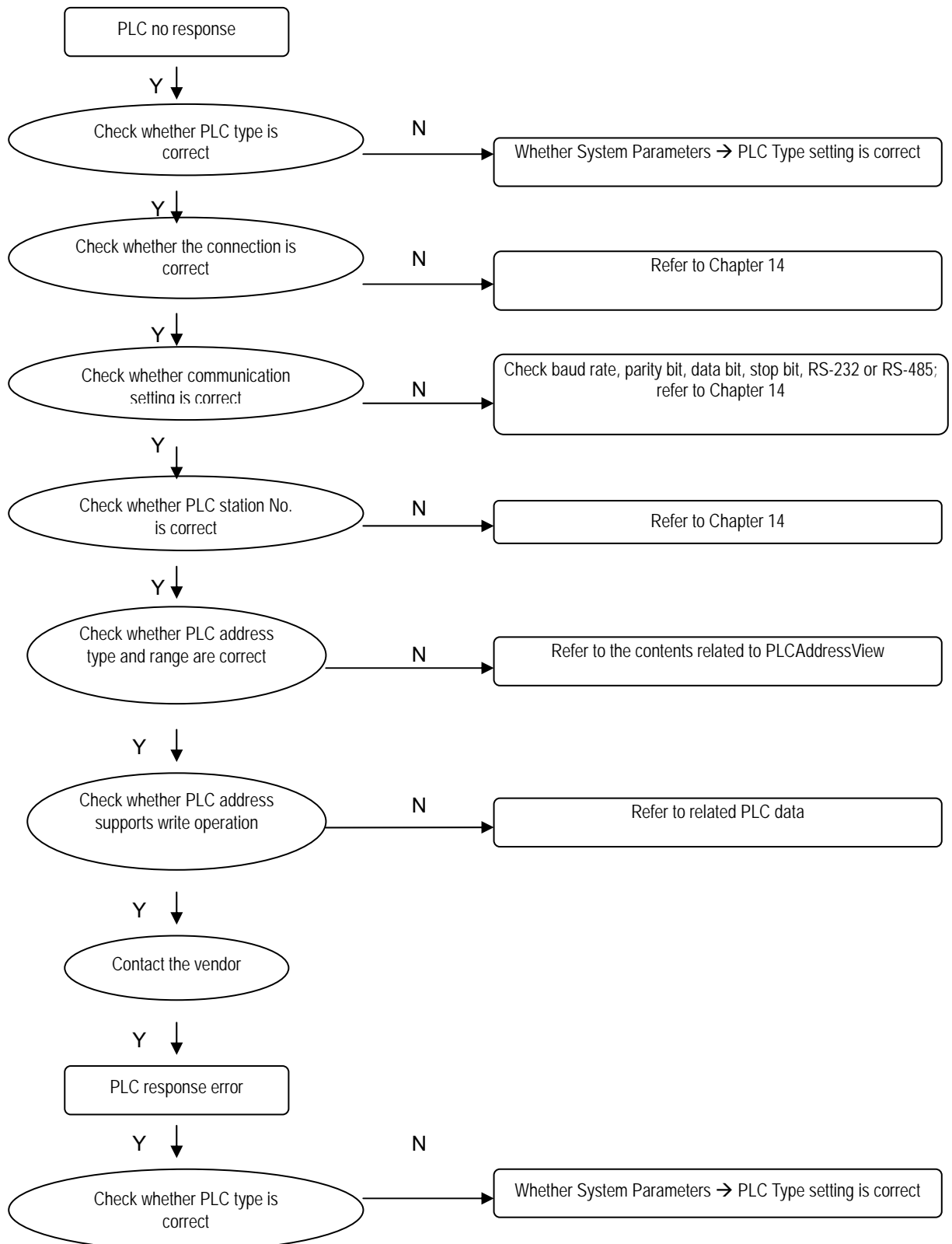

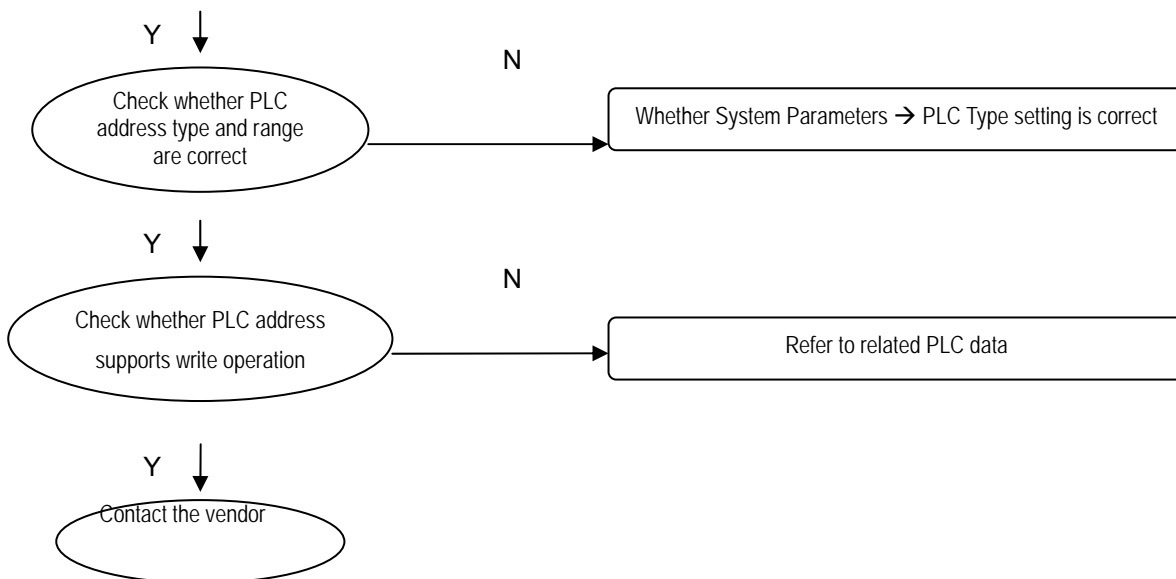

Fault with compilation information:

The user can view the number of errors as well as causes in the compilation information window.

1. Address error or threshold crossing of PLC component, as shown in the following figure:

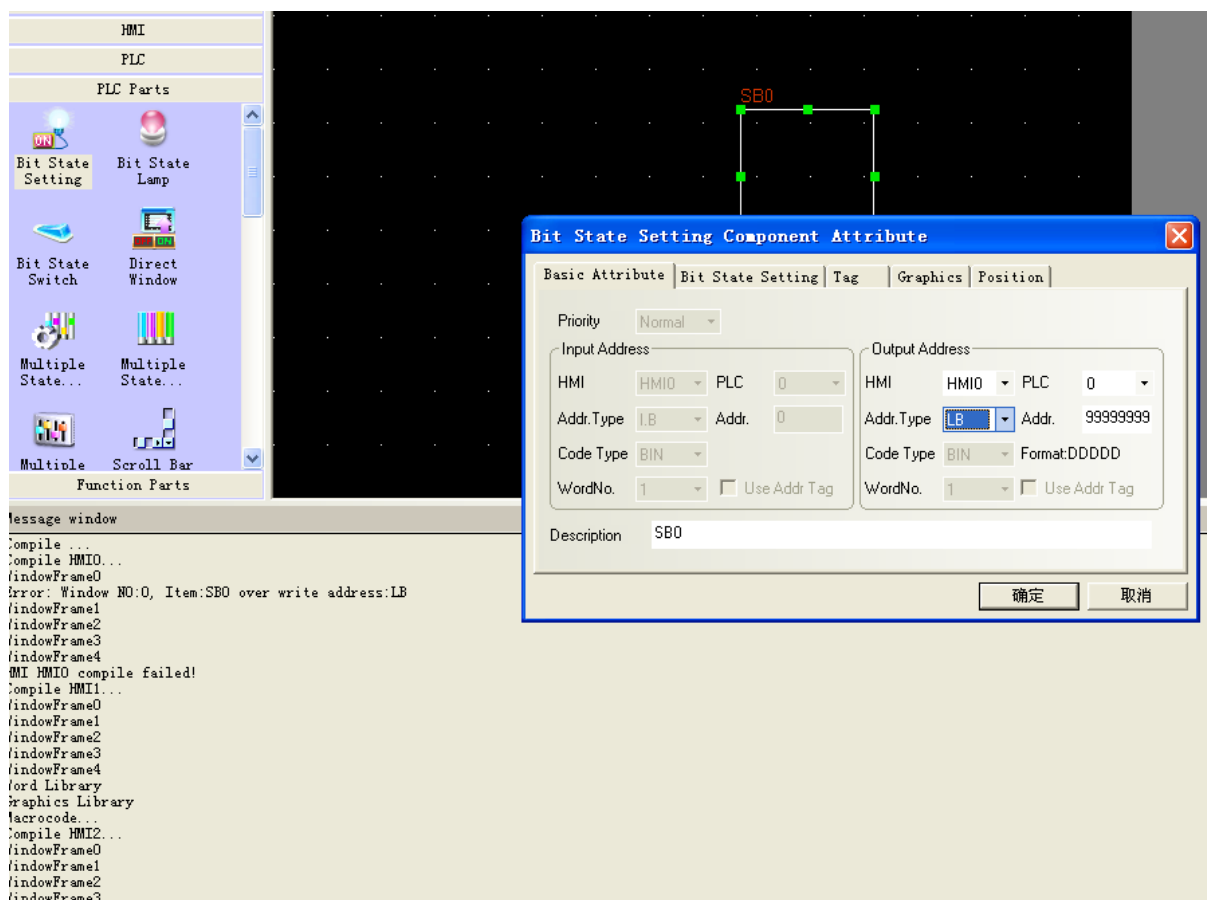

Refer to Chapter 14 for address range of PLC components or refer to related PLC data to modify

the PLC component address.

2. Macro programming error, as shown in the following figure (simulation of a wrong macro):

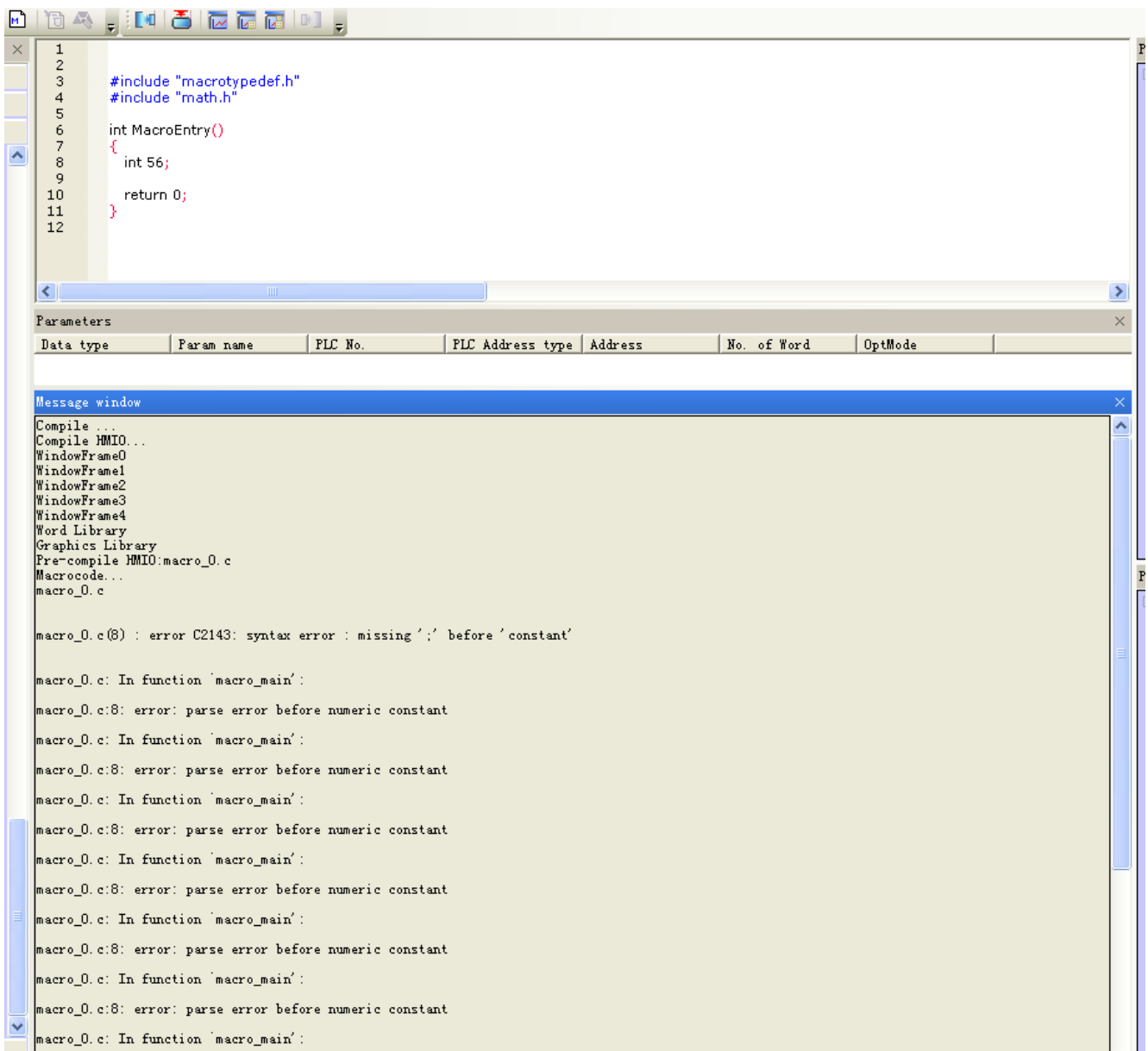

For programs used to modify macro instructions, refer to Chapter 9.

Appendix III Hardware Overview

Installation of MT5000 Series Touch Screens

1. Installation Overview

1.1 Installation Environment

Application environment

MT5000 series touch screens are industrial products designed for factory applications. They are designed to work stably in most industrial environments at the temperature of 32 ~ 113°F (0~45°C). They may not be applied to some specific outdoor environments. For specific outdoor applications, do consult your vendor!

NEMA rating (NEMA stands for National Electrical Manufacturers Association)

The front panel of MT5000 series touch screens conforms to the specifications of NEMA 4. When the product is correctly installed in a panel in compliance with the NEMA 4 specifications, the panel still meets the protection requirements of NEMA 4, that is, no liquid will seep through the panel when the panel surface is sprayed with liquid.

Electrical environment

It is proved by test that MT5000 series touch screens meet CE standard. In other words, the circuit design of the product is able to withstand the interference of electrical noise, but it cannot eliminate electrical noise under all circumstances. Correct cabling and correct grounding ensure normal operation of the product.



Mechanical environment

To ensure normal operation of the product, do not install MT5000 series touch screens in the environment where severe mechanical vibration or shocks are present.

2. Installation Instructions

2.1 Installation Instructions

2.1.1 Location Considerations

Care should be taken when locating any equipment behind the MT5000 series of products to ensure AC power wiring, PLC output modules, contactors, starters and relays, and any other source of electrical interface are kept away from the back of these products.

Particular care should be taken to the position of variable frequency drivers and switching power supplies. Their input and output cables should be screened to a star earth point.

2.1.2 Making a NEMA-4 Mounting

**Panel
Details**

The MT5000 series of products can be mounted into panels with a depth of over 105 mm. It is recommended that the product be installed on the front panel of a steel enclosure. To enable the user to open the front panel of the panel smoothly, allow a clearance of at least 25 mm around the sides of the installed product. To ensure smooth and easy connection of power supply and cables, it is recommended that a panel with a depth of at least 105 mm should be adopted.

**NEMA-4
Installation**

Put the unit through the panel holes. Slide the clamps into the 4 holes provided around the case. Tighten the clamping screws in an even pattern until the unit is secured in the panel.

Caution! Do not over-tighten mounting clamps!

Specifications Note:

Note: To seal to NEMA-4 specifications, all supplied mounting clamps must be used and panel cannot flex more than 0.010".

2.1.3 Environmental Considerations



- The MT5000 series are to be used indoors as built-in LCD displays. Make sure that the displays are installed correctly and that operating limits are followed (See Hardware Specifications).
- Do not operate the unit in areas subject to explosion hazards due to flammable gases, vapors or dusts.
- The unit should not be installed where fast temperature variations and/or high humidity are present. This will cause condensation of water in the device and cause damage to the unit.

2.2 Power Connections

Make sure all local and national electrical standards are met when installing the unit. For details, refer to a local dealer.

2.2.1 Power Requirements



Power Supply Input voltage: 24V ±15%
 Current: **Starting current:** 5300L<1A, 5400T<1.2A,
 5500T<1.2A
 Working current: 5300L<500mA,
 5400T<600mA, 5500T<600mA



Fusing Requirement If the display does not come on within 2 seconds of power-up, turn off the power immediately. An internal fuse will prevent damage if the polarity of the DC power is incorrect. Check wiring to ensure proper connections and try to power up again.



- Caution!** An Internal fuse will prevent damage for over voltage condition, however it isn't guaranteed.
- High Voltage** DC voltage sources should provide proper isolation from main AC power.



- Caution!** A hard-wired Emergency Stop should be fitted in any system using the MT5000 touch screens to comply with the ICS Safety Recommendations.



- Caution!** Do not power the MT5000 touch screens and inductive loads, or input circuitry to the controller, with the same **Supply Voltage** power supply.

- Condition** Note: The 24 VDC output from some controllers may not have enough current to power the MT5000.



- Wire lengths of DC power should be minimized (Maximum 500 m (shielded), 300 m (unshielded twisted pairs)).
- Twisted pairs are recommended for use.
- If the wiring is to be exposed to lightning or surges, take appropriate lightning protection measures and use appropriate lightning arresting devices.
- Caution!** **Wire Routing** Keep AC, high energy, and rapidly switching DC wiring separate from signal cables.
- Equip ungrounded DC supplies with a resistor and capacitor in parallel to earth ground. This provides a path for static and high frequency dissipation. Typical values to use are 1 MOhm and 4700 pF.
- To make a connection, strip about 3/8" of insulation off the end of the wire (furcate terminal recommended), turn the connector screw counterclockwise until the gap is wide open, insert the wire all the way in, and turn the screw clockwise until it's tight.
- Connection** Connect positive DC line to the '+24V' terminal and the DC ground to the '0V' terminal.

2.2.2 Grounding Requirements



Chassis ground must be used. DC ground is not directly coupled to earth ground internally. It is preferable not to ground DC negative return to chassis ground as poor site earths can introduce noise into a system, but if necessary an earth connection should be made, from the power supply

return point to the star earth point. Ground conductors should be as short and as large in size as possible. The conductors must always be large enough to carry the maximum short circuit current. Ground conductors should be connected to a star earth ground point. This ensures that no ground conductor carries current from any other branch.

2.2.3 CE Requirements

To make the MT5000 series comply with EMC directives, and to reduce susceptibility to electrical interference, a separate #14 AWG ground wire should be taken to the chassis ground terminal of the power connector. This ground connection should be run directly to the star earth connection point.

2.2.4 Safety Guidelines

This section presents recommended installation practices and procedures. Since no two applications are identical, these recommendations should be considered as guidelines.

Hardware

Considerations



Caution!

The system designer should be aware that devices in controller systems could fail and thereby create an unsafe condition. Furthermore, electrical interference in an operator interface, such as an MT5000 touch screen, can lead to equipment start-up, which could result in property damage and/or physical injury to the equipment operator.

If you, or your company, use any programmable control systems that require an operator or attendant, you should be aware that this potential safety hazard exists and take appropriate precautions. Although the specific design steps depend on your particular application, the following precautions generally apply to installation of solid-state programmable control devices. In addition, these precautions conform to the guidelines for installation of controllers as recommended in the NEMA ICS 3-304 Control Standards.

Programming

Considerations



To conform to ICS Safety Recommendations, checks should be placed in the controller to ensure that all writable registers that control critical parts of plant or machinery have limit checks built into the program, with an out-of-limit safe shutdown procedure to ensure safety of personnel.

ICS 3-304.81 Safety Recommendations:

Consideration should be given to the use of an emergency stop function, which is independent of the programmable controller.

Where the operator is exposed to the machinery, such as in loading or unloading a machine tool, or where the machine cycles automatically, consideration should be given to the use of an electromechanical override or other redundant means, independent of the programmable controller, for starting and interrupting the cycle.

If provision is required for changing programs while the equipment is in operation, consideration should be given to the use of locks or other means of assuring that only authorized personnel can make such changes.

* These recommendations are intended as safeguards against the failure of critical components and the effects of such failures or the inadvertent errors that might be introduced if programs are changed while the equipment is in operation.

- The ICS 3-304.81 Safety Recommendations are reproduced by permission of the National Electrical Manufacturers Association from NEMA ICS 3-304.

2.3 Communications Connections

The ports as you look at the back of the case, are the ports for connecting to a printer, a PLC or some other external device (Controller Connectors).

2.3.1 Connection with External Devices

Different cables are required for various devices.

Cable requirements

Restrict cable length to less than 150m for Rs-485/422 devices and 15m for RS-232 devices to avoid communications problems.

Caution

The display will give a prompt of “PLC no response...” for each communications fault until the communication resumes normal. The COM indicator on the front panel will light up in each communication.

Caution!

Do not insert or pull out the cable while the power is on.

Shielded cables must be used for long lengths or cables run in an electrically noisy environment.

Do not run cables next to AC power lines or near sources of electrical noise.

Be sure that the cable ends have been inserted all of the way into mating connectors and are secure.

Pin Designations

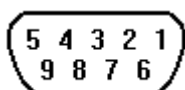

COM0

Pin assignment of the 9-pin male, D-SUB, COM0. This port is used to connect the MT5000 series touch screens and provides RS-232/485/422 port controller.

Note: This port is used for MT5000 programming and debugging at the same time.

Pin #	Signal	PLC [RS-485] 4 wire	PLC [RS-485] 2 wire	PLC [RS-232]	PC[RS-232]
1	Rx- (A)	RS-485 Rx	RS485A		
2	RxD_PLC			RS232 Rx	
3	TxD_PLC			RS-232 Tx	
4	Tx-	RS-485 Tx			
5	GND	Signal ground			
6	Rx+(B)	RS-485 Rx	RS485B		
7	RxD_PC				RS-232 Rx
8	TxD_PC				RS-232 Tx
9	Tx+	RS-485 Tx			

Pin

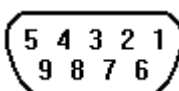

Designations

COM1

Pin assignment of the 9-pin female, D-SUB, COM1. This port is used to connect the MT5000 series touch screens and provides RS-232 port controller.

Pin assignment of this port is basically the same as COM0. The only difference is that COM0 is connected with the RS-232 interface of the PC to serve as the hardware flow control signal for PLC-232 connection.

Pin #	Signal	PLC [RS-485] 4 wire	PLC [RS-485] 2 wire	PLC [RS-232]
1	Rx- (A)	RS-485 Rx	RS485A	

2	RxD_PLC			RS-232 Rx
3	TxD_PLC			RS-232 Tx
4	Tx-	RS-485 Tx		
5	GND	Signal ground		
6	Rx+(B)	RS-485 Rx	RS485B	
7	CTS_PLC			Clear to send input
8	RTS_PLC			Ready to send output
9	Tx+	RS-485 Tx		

2.3.2 Connection with PC

The COM0 port on the back of the case can be used to connect PLC RS-232/485/422 devices and can also be used to connect with the programming interface and setting interface of a PC.

Connection The port can be connected to a PC through a dedicated cable (P/N: MT5000-PC).

Port Function Due to the reason of communication rate, the COM0 port of a PC is only used for configuration downloading and parameter setting, and it will not be used for indirect online simulation.

Pin arrangement of 9-pin, male, D-SUB COM0

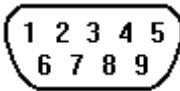
Pin Designations	Pin #	Signal	PLC [RS-485] 4 wire	PLC [RS-485] 2 wire	PLC [RS-232]	PC[RS-232]	
	1	Rx- (A)	RS-485 Rx	RS485A			
	2	RxD_PLC			RS-232 Rx		
	3	TxD_PLC			RS-232 Tx		
	4	Tx-	RS-485 Tx				
	5	GND	Signal ground				
	6	Rx+(B)	RS-485 Rx	RS485B			
	7	RxD_PC				RS-232 Rx	
	8	TxD_PC				RS-232 Tx	
	9	Tx+	RS-485 Tx				

COM0

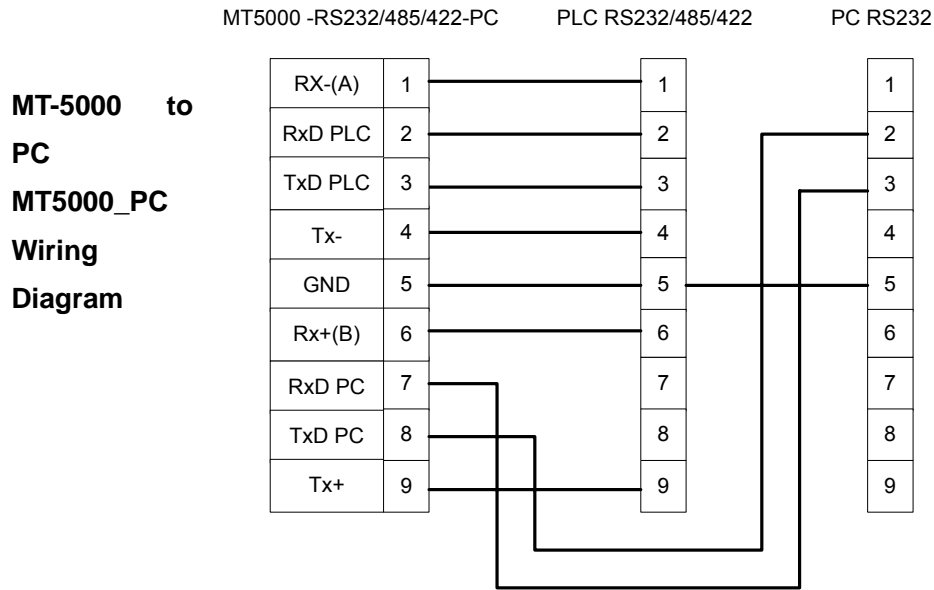

2.3.3 USB Connection

The USB port on the back of the case is the USB Slave device used to connect with a PC for configuration downloading and HMI setting. It cannot be used to connect with peripheral equipment such as a USB printer.

Connection USB Slave port can be connected with a PC through a general USB cable.

Port Function The port is only used to download user configuration program to the HMI and to set HMI system parameters.

Port Diagram

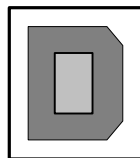

2.3.4 Connection with Ethernet

The Ethernet port on the back of the case is a 10/100M adaptive Ethernet port. It is can be used for HMI configuration downloading, HMI system parameter setting, and indirect online simulation of configurations. In addition, multiple HMIs can be connected through the Ethernet to create an HMI application.

Connection This port is connected with the HUB or Switch through a standard Ethernet cable (RJ-45 straight-through cable) and then connected to a LAN. It can also be directly connected with the Ethernet port of a PC through a dual system interconnection cable (RJ-45 crossover cable).

Port Function This port can be used for HMI configuration downloading, HMI system parameter setting, and indirect online simulation of configurations. In addition, multiple HMIs can be connected through the Ethernet to create an HMI application.

Port Diagram

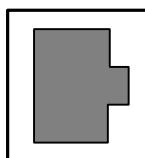

2.3.5 Connection with Printer

The parallel printer port on the back of the case can be used to connect with various parallel port printers on the market.

The full series of MT5000 products support printout function. The printing port will export data when the printing component works.

Printout

The MT5000 series touch screens support multiple printers with parallel ports, and eView HMItek Ltd. will continuously provide drivers for various brands of printers.

Note: The length of the connection cable of a printer shall not exceed 5m.

Pin Designations

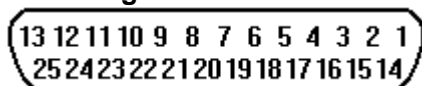

Pin assignment of 25-pin, D-SUB, female, parallel printer port

PRINTER

Pin#	Signal	Function	Pin#	Signal	Function
1	STB	Output	11	BUSY	Input
2	DATA0	Output	15	ERROR	Input
3	DATA1	Output	16	INIT	Output
4	DATA2	Output	17-25	GND	Signal ground
5	DATA3	Output			
6	DATA4	Output			
7	DATA5	Output			
8	DATA6	Output			
9	DATA7	Output			

2.3.6 DIP Switch

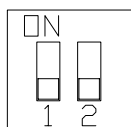

SW1	SW2	Working Mode
ON	ON	System Setting Mode
OFF	ON	Touch Screen Calibrate Mode
ON	OFF	Firmware Update and Basic Parameter Setting Mode
OFF	OFF	Application (Online Operation) Mode

- **System Setting Mode:** In this mode, the touch screen will start a built-in system setting interface, where the user can set such parameters as IP address, brightness, contrast, and buzzer.
- **Touch Screen Calibrate Mode:** In this mode when you touch the screen, the screen will display a “+” sign, through which you can calibrate the touch accuracy of the screen.
- **Firmware Update and Basic Parameter Setting Mode:** In this mode the user can update firmware, set IP address, and perform other lower-level operations. In general, do not use this mode.
- **Application (Online Operation) Mode:** This is the normal working mode of MT5000 series touch screens. The screen will display the starting picture of the downloaded project.

2.4 CE Requirements

The MT-5000 series of touch screens conform to the following CE specifications:

- EMC Directive (89/336/EEC, 92/31/EEC, 93/68/EEC) electromagnetic emissions and immunity;
- Machinery Directive (89/392/EEC, 91/368/EEC, 93/44/EEC, 93/ 68/EEC) machine safety;
- MT5000 series products will be CE-marked to indicate compliance with the EMC Directive.

The MT5000 series has been designed to operate satisfactorily in electromagnetic noise (immunity) and without emitting high levels of electrical noise into the environment (emission). The units are designed to meet European Community standards when installed per the wiring instructions in this manual.

Compatibility Standards

The MT5000 series touch screens have been designed to meet electromagnetic compatibility for industrial environments.

- CISPR (EN 55011) Group 1, Class A Radiated Emission levels
- EN61000-6-4/2001, Generic standards – Emission standard for industrial environments
- EN61000-6-2/2001 Immunity for Industrial Environments
- EN61000-4/-2/-3/-4/-5/-6 Electrostatic discharge, electrostatic field immunity test, electrical fast transient/burst, surge immunity test, immunity to conducted disturbance

3. Programming Software

Programming Software	EV 5000 V1.0.0 or later
----------------------	-------------------------

4. Product Specifications

MT5300 Basic Parameters

Model	5300L	5300S	5300T
Case color	Dark grey/off white/computer grey		
Display	5.7STN	5.7CSTN	5.7TFT
Resolution	320×240 dots		
Brightness	220cd/m ²	350 cd/m ²	350 cd/m ²
Color	256 grey scale	64K color	64K color
Backlight	1CCFL	1CCFL	1CCFL
Touch screen	4-wire precision resistance network		
CPU	200M~400MHz RISC		
Memory	8M FLASH, 16M SDRAM		
COM port	2 RS/232/485/422, 1 10/100M Ethernet, 1USB SLAVE		
Recipe memory	256K WORD		
Printer port	1 DB25		
General specifications			
Power supply	21~28VDC working current Max 400mA @ 24V starting current Max 600mA @24V		
CE certification	Complies with EN61000-6-4/2001: EN55011, EN61000-6-2/2001, EN61000-4-2/-3/-4/-5/-6 standard		
FCC compatibility	Complies with FCC Class A		
Dielectric strength test	500 VAC 1 minute		
Insulation resistance	Greater than 50M Ω@ 500V DC		
Shockproof test	10~25Hz (X, Y, Z direction, 2G, 30 minutes)		
Degree of protection	IP65 (front panel)		
Operating temperature	0~45°C		
Operating humidity	10~90% non-condensing		
Case materials	ABS		
Dimensions	192×139×60mm		
Dimensions of installation holes	180×127 mm		
Weight	0.85kg		
Cooling method	Natural air cooling		

MT5300 Dimensional Drawing

Unit: mm (inch)

Front View

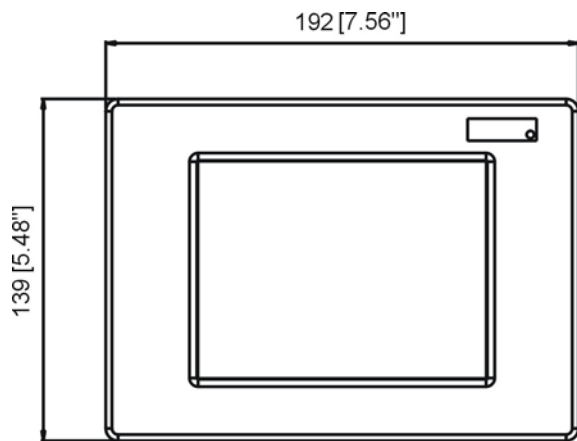

Side View

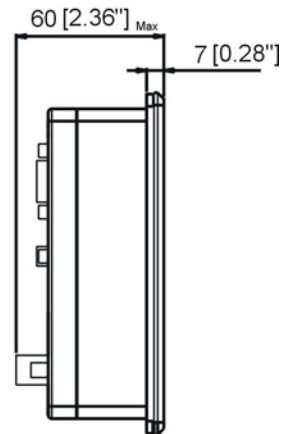

Top View

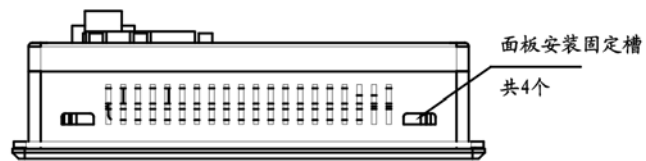

Rear View

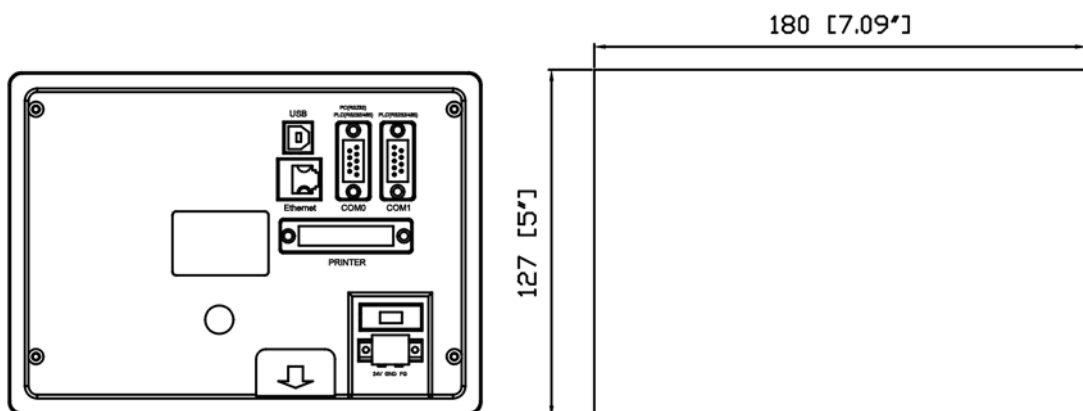

MT5400 Basic Parameters

Model	5400S	5400T
Case color	Dark grey/off white/computer grey	
Display	7.5CSTN	7.5TFT
Resolution	640×480 dots	
Brightness	200 cd/m ²	370 cd/m ²
Color	64K color	64K color
Backlight	2CCFL	2CCFL
Touch screen	4-wire precision resistance network	
CPU	200MHz RISC	
Memory	8M FLASH, 16M SDRAM	
COM port	2 RS/232/485/422, 1 10/100M Ethernet, 1USB SLAVE	
Recipe memory	256K WORD	
Printer port	1 DB25	
General specifications		
Power supply	21~28VDC working current Max 400mA @ 24V starting current MAX 600mA @24V	
CE certification	Complies with EN61000-6-4/2001: EN55011, EN61000-6-2/2001, EN61000-4-2/-3/-4/-5/-6 standard	
FCC compatibility	Complies with FCC Class A	
Dielectric strength test	500 VAC 1 minute	
Insulation resistance	Greater than 50MΩ @ 500V DC	
Shockproof test	10~25Hz (X, Y, Z direction, 2G, 30 minutes)	
Degree of protection	IP65 (front panel)	
Operating temperature	0~45 °C	
Operating humidity	10~90% non-condensing	
Case materials	ABS	
Dimensions	235×172×61.1 mm	
Dimensions of installation holes	224×161 mm	
Weight	1.1kg	
Cooling method	Natural air cooling	

MT5400 Dimensional Drawing

Unit: mm (inch)

Front View

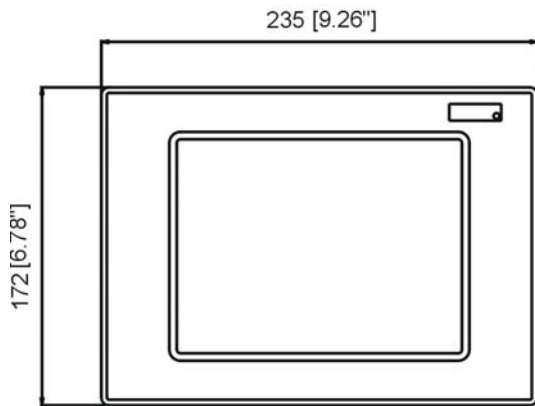

Side View

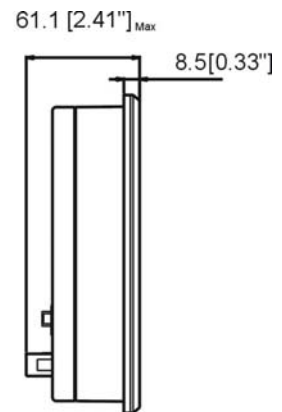

Top View

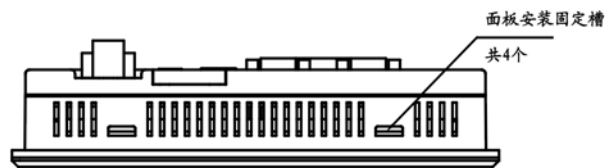

Rear View

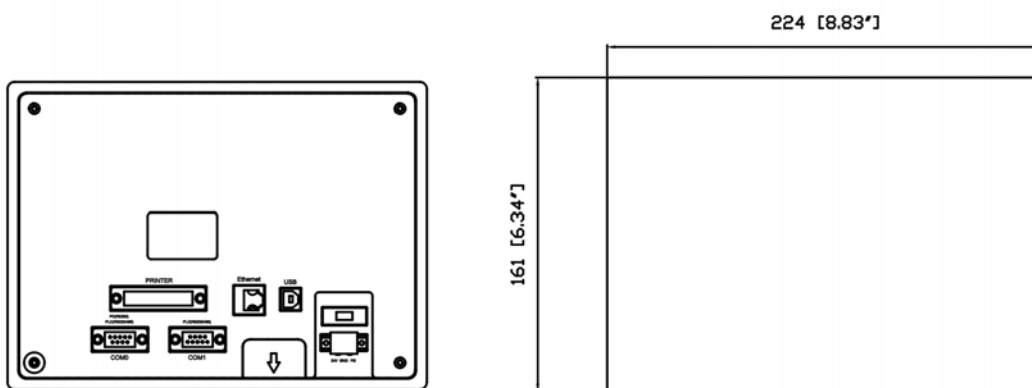

MT5500 Basic Parameters

Model	5500L	5500T
Case color	Metallic grey	
Display	10.4STN	10.4TFT
Resolution	640×480	
Brightness	100 cd/m ²	250 cd/m ²
Color	256 grey scale	64K color
Backlight	1CCFL	2CCFL
Touch screen	4-wire precision resistance network	
CPU	200MHz RISC	
Memory	8M FLASH, 16M SDRAM	
COM port	2 RS/232/485/422, 1 10/100M Ethernet, 1 USB SLAVE	
Recipe memory	256K WORD	
Printer port	1 DB25	
General specifications		
Power supply	21~28VDC working current Max 400mA @ 24V starting current Max 600mA @24V	
CE certification	Complies with EN61000-6-4/2001: EN55011, EN61000-6-2/2001, EN61000-4-2/-3/-4/-5/-6 standard	
FCC compatibility	Complies with FCC Class A	
Dielectric strength test	500 VAC 1 minute	
Insulation resistance	Greater than 50MΩ @ 500V DC	
Shockproof test	10~25Hz (X, Y, Z direction, 2G, 30 minutes)	
Degree of protection	IP65 (front panel)	
Operating temperature	0~45	
Operating humidity	10~90% non-condensing	
Case materials	Aluminum alloy	
Dimensions	300×226×61.6 mm	
Dimensions of installation holes	298×218 mm	
Weight	3.3kg	
Cooling method	Natural air cooling	

MT5500 Dimensional Drawing

Unit: mm (inch)

Front View

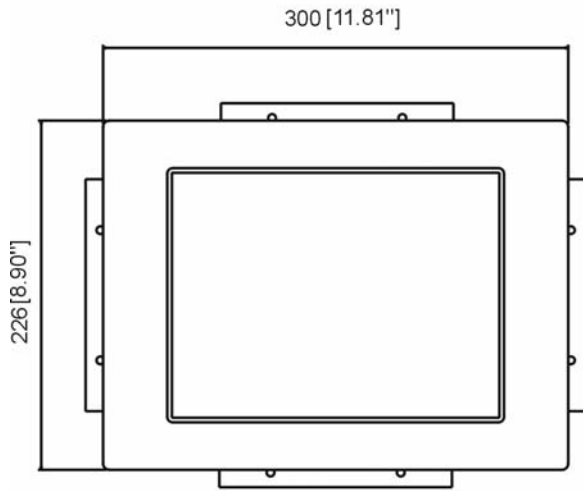

Side View

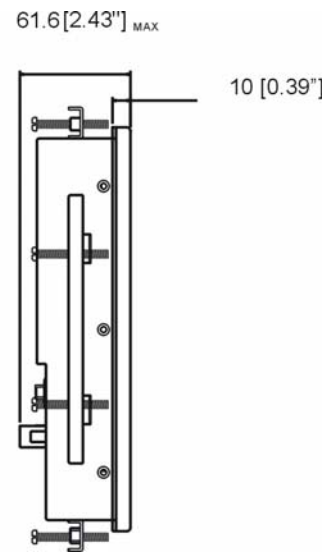

Top View



Rear View

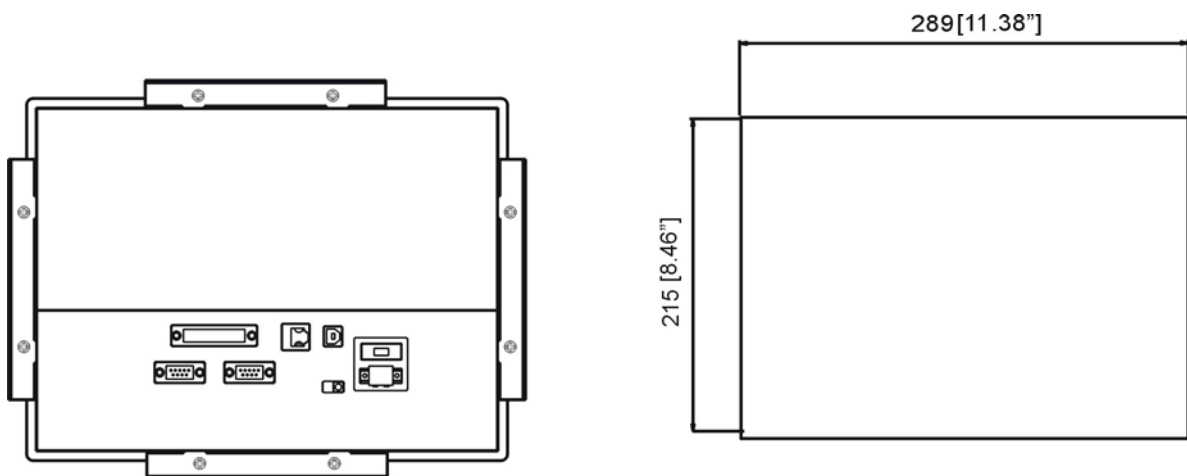

MT5600T Basic Parameters

Model	MT5600T
Case color	Metallic grey
Display	12.1TFT
Resolution	800×600
Brightness	200 cd/m ²
Color	64K color
Backlight	2CCFL
Touch screen	4-wire precision resistance network
CPU	400MHz RISC
Memory	8M FLASH, 16M SDRAM
COM port	2 RS/232/485/422, 1 10/100M Ethernet, 1 USB SLAVE
Recipe memory	256K WORD
Printer port	1 DB25
General specifications	
Power supply	21~28VDC working current Max 600mA @ 24V starting current Max 800mA @24V
CE certification	Complies with EN61000-6-4/2001: EN55011, EN61000-6-2/2001, EN61000-4-2/-3/-4/-5/-6 standard
FCC compatibility	Complies with FCC Class A
Dielectric strength test	500 VAC 1 minute
Insulation resistance	Greater than 50MΩ @ 500V DC
Shockproof test	10~25Hz (X, Y, Z direction, 2G, 30 minutes)
Degree of protection	IP65 (front panel)
Operating temperature	0~45
Operating humidity	10~90% non-condensing
Case materials	Aluminum alloy
Dimensions	350×264×47 mm
Dimensions of installation holes	328×242 mm
Weight	4Kg
Cooling method	Natural air cooling

MT5600 Dimensional Drawing

Unit: mm (inch)

Front View

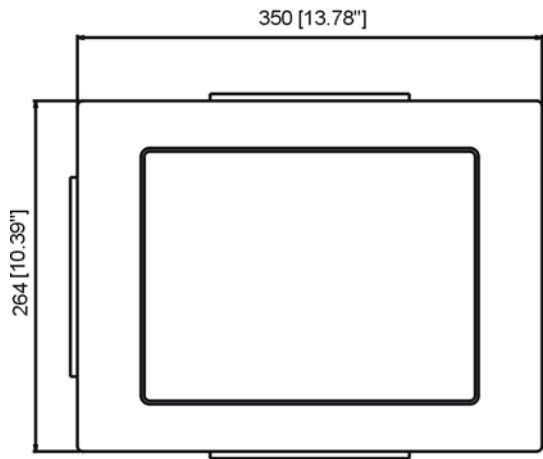

Side View

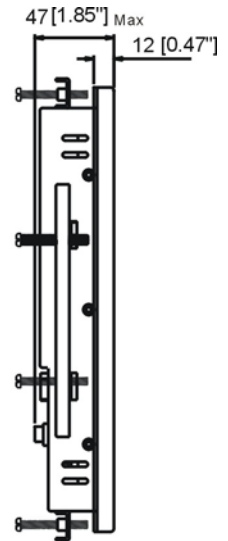

Top View



Rear View

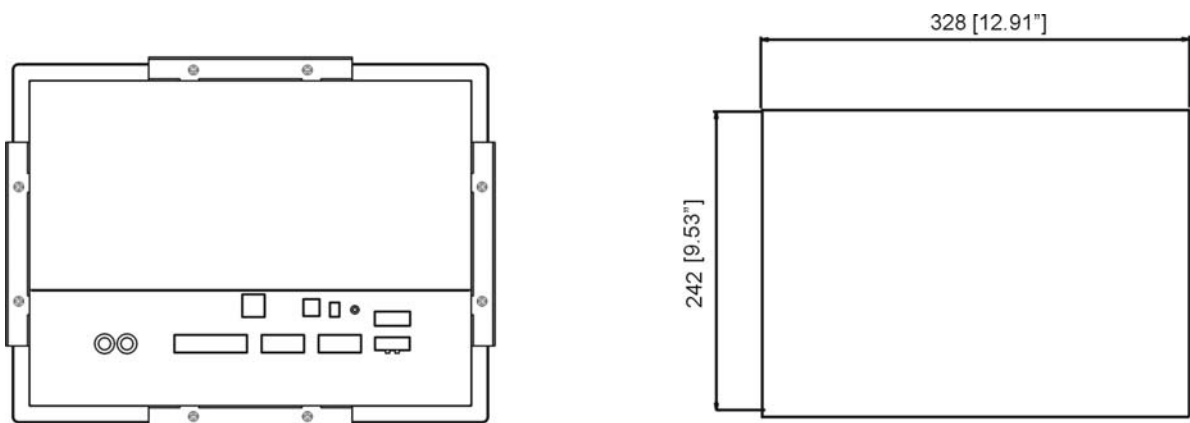

MT5700T Basic Parameters

Model	MT5700T
Case color	Metallic grey
Display	15.0TFT
Resolution	1024×768
Brightness	250 cd/m ²
Color	64K color
Backlight	2CCFL
Touch screen	4-wire precision resistance network
CPU	400MHz RISC
Memory	8M FLASH, 16M SDRAM
COM port	2 RS/232/485/422, 1 10/100M Ethernet, 1 USB SLAVE
Recipe memory	256K WORD
Printer port	1 DB25
General specifications	
Power supply	21~28VDC working current Max 750mA @ 24V starting current Max 900mA @24V
CE certification	Complies with EN61000-6-4/2001: EN55011, EN61000-6-2/2001, EN61000-4-2/-3/-4/-5/-6 standard
FCC compatibility	Complies with FCC Class A
Dielectric strength test	500 VAC 1 minute
Insulation resistance	Greater than 50MΩ @ 500V DC
Shockproof test	10~25Hz (X, Y, Z direction, 2G, 30 minutes)
Degree of protection	IP65 (front panel)
Operating temperature	0~45
Operating humidity	10~90% non-condensing
Case materials	Aluminum alloy
Dimensions	406.5×331.5×45 mm
Dimensions of installation holes	388×295mm
Weight	5.1Kg
Cooling method	Natural air cooling

MT5700 Dimensional Drawing

Unit: mm (inch)

Front View

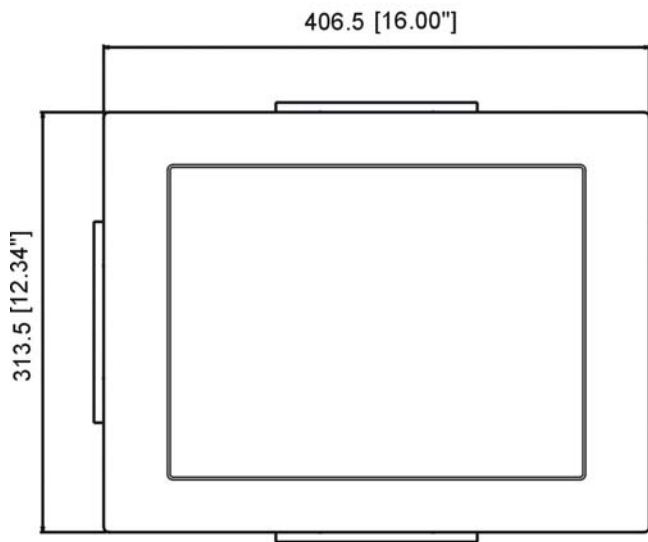

Side View

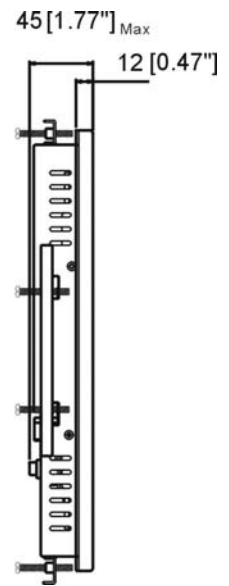

Top View



Rear View

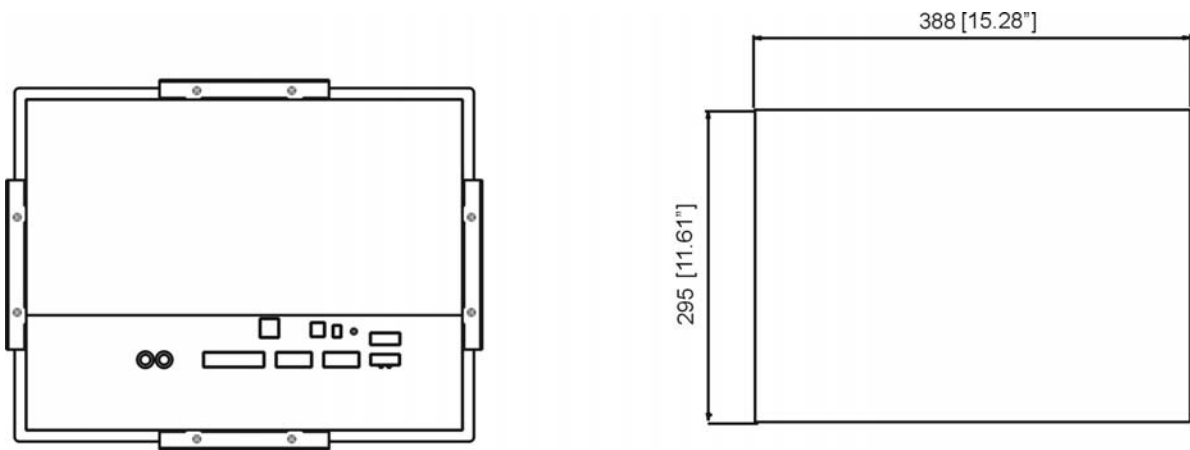

Installation of MT4000 Series Touch Screens

1. Installation Overview

1.1 Installation Environment

Application environment

The MT4000 series touch screens are industrial products designed for factory applications. They are designed to work stably in most industrial environments at 32 ~ 113°F (0~45°C). They may not be applied to some specific outdoor environments. For specific outdoor applications, do consult your vendor!

NEMA rating (NEMA stands for National Electrical Manufacturers Association)

The front panel of the MT4000 series touch screens conforms to the specifications of NEMA 4. When the product is correctly installed in a panel in compliance with NEMA 4 specifications, the panel still meets the protection requirements of NEMA 4, that is, no liquid will seep through the panel when the panel surface is sprayed with liquid.

Electrical environment

It is proved by test that the MT4000 series touch screens meet CE standard. In other words, the circuit design of the product is able to withstand the interference of electrical noise, but it cannot eliminate electrical noise under all circumstances. Correct cabling and correct grounding ensure normal operation of the product.



Mechanical environment

To ensure normal operation of the product, do not install the MT4000 series touch screens in the environment where severe mechanical vibration or shocks are present.

2. Installation Instructions

2.1 Installation Instructions

2.1.1 Location Considerations

Care should be taken when locating any equipment behind the MT4000 series of products to ensure AC power wiring, PLC output modules, contactors, starters and relays, and any other source of electrical interface are kept away from the back of these products.

Particular care should be taken to the position of variable frequency drivers and switching power supplies. Their input and output cables should be screened to a star earth point.

2.1.2 Making a NEMA-4 Mounting

**Panel
Details**

The MT4000 series of products can be mounted into panels with a depth of over 105 mm. It is recommended that the product be installed on the front panel of a steel enclosure. To enable the user to open the front panel of the panel smoothly, allow a clearance of at least 25 mm around the sides of the installed product. To ensure smooth and easy connection of power supply and cables, it is recommended that a panel with a depth of at least 105 mm should be adopted.

**NEMA-4
Installation**

Put the unit through the panel holes. Slide the clamps into the 4 holes provided around the case. Tighten the clamping screws in an even pattern until the unit is secured in the panel.

Caution! Do not over-tighten mounting clamps!

Specifications Note:

Note: To seal to NEMA-4 specifications, all supplied mounting clamps must be used and panel cannot flex more than 0.010".

2.1.3 Environmental Considerations



- The MT4000 series are to be used indoors as built-in LCD displays. Make sure that the displays are installed correctly and that operating limits are followed (See Hardware Specifications).
- Do not operate the unit in areas subject to explosion hazards due to flammable gases, vapors or dusts.
- The unit should not be installed where fast temperature variations and/or high humidity are present. This will cause condensation of water in the device and cause damage to the unit.

2.2 Power Connections

Make sure all local and national electrical standards are met when installing the unit. For details, refer to a local dealer.

2.2.1 Power Requirements

**Power Supply**

Input voltage: 24V \pm 15%

Current: Starting current : 4300L<1A, 4300S<1A, 4300C<1.2A, 4300T<1.2A

Working current : 4300L<500mA, 4300S<500mA , 4300C<600mA, 4300T<600mA

**Fusing
Requirement**

If the display does not come on within 2 seconds of power-up, turn off the power immediately. An internal fuse will prevent damage if the polarity of the DC power is incorrect. Check wiring to ensure proper connections and try to power up again.

**Caution!**

An Internal fuse will prevent damage for over voltage condition, however it isn't guaranteed.

High Voltage

DC voltage sources should provide proper isolation from main AC power.

**Caution!****Emergency Stop**

A hard-wired Emergency Stop should be fitted in any system using the MT4000 touch screens to comply with ICS Safety Recommendations.

**Caution!****Supply Voltage Condition**

Do not power the MT4000 touch screens and inductive loads, or input circuitry to the controller, with the same power supply.

Note: The 24 VDC output from some controllers may not have enough current to power the MT4000.

**Caution!****Wire Routing**

Wire lengths of DC power should be minimized (Maximum 500 m (shielded), 300 m (unshielded twisted pairs)).

Twisted pairs are recommended for use.

If wiring is to be exposed to lightning or surges, take appropriate lightning protection measures and use appropriate lightning arresting devices.

Keep AC, high energy, and rapidly switching DC wiring separate from signal cables.

Equip ungrounded DC supplies with a resistor and capacitor in parallel to earth ground. This provides a path for static and high frequency dissipation. Typical values to use are 1 MOhm and 4700 pF.

Connection

To make a connection, strip about 3/8" of insulation off the end of the wire (furcate terminal recommended), turn the connector screw counterclockwise until the gap is wide open, insert the wire all the way in, and turn the screw clockwise until it's tight.

Connect positive DC line to the '+24V' terminal and the DC ground to the '0V' terminal.

2.2.2 Grounding Requirements



Chassis ground must be used. DC ground is not directly coupled to earth ground internally. It is preferable not to ground DC negative return to chassis ground as poor site earths can introduce noise into a system, but if necessary an earth connection should be made, from the power supply return point to the star earth point. Ground conductors should be as short and as large in size as possible. The conductors must always be large enough to carry the maximum

short circuit current. Ground conductors should be connected to a star earth ground point. This ensures that no ground conductor carries current from any other branch.

2.2.3 CE Requirements

To make the MT4000 series comply with EMC directives, and to reduce susceptibility to electrical interference, a piece of separate #14 AWG ground wire should be taken to the chassis ground terminal of the power connector. This ground connection should be run directly to the star earth connection point.

2.2.4 Safety Guidelines

This section presents recommended installation practices and procedures. Since no two applications are identical, these recommendations should be considered as guidelines.

Hardware

Considerations



Caution!

The system designer should be aware that devices in controller systems could fail and thereby create an unsafe condition.

Furthermore, electrical interference in an operator interface, such as an MT4000 touch screen, can lead to equipment start-up, which could result in property damage and/or physical injury to the equipment operator.

If you, or your company, use any programmable control systems that require an operator or attendant, you should be aware that this potential safety hazard exists and take appropriate precautions.

Although the specific design steps depend on your particular application, the following precautions generally apply to installation of solid-state programmable control devices. In addition, these precautions conform to the guidelines for installation of controllers as recommended in the NEMA ICS 3-304 Control Standards.

Programming

Considerations



To conform to ICS Safety Recommendations, checks should be placed in the controller to ensure that all writable registers that control critical parts of plant or machinery have limit checks built into the program, with an out-of-limit safe shutdown procedure to ensure safety of personnel.

ICS 3-304.81 Safety Recommendations:

Consideration should be given to the use of an emergency stop function, which is independent of the programmable controller.

Where the operator is exposed to the machinery, such as in loading or unloading a machine tool, or where the machine cycles automatically, consideration should be given to the use of an electromechanical override or other redundant means, independent of the programmable

controller, for starting and interrupting the cycle.

If provision is required for changing programs while the equipment is in operation, consideration should be given to the use of locks or other means of assuring that only authorized personnel can make such changes.

* These recommendations are intended as safeguards against the failure of critical components and the effects of such failures or the inadvertent errors that might be introduced if programs are changed while the equipment is in operation.

- The ICS 3-304.81 Safety Recommendations are reproduced by permission of the National Electrical Manufacturers Association from NEMA ICS 3-304.

2.3 Communications Connections

The ports as you look at the back of the case, are the ports for connecting to a printer, a PLC or some other external device (Controller Connectors).

2.3.1 Connection with External Devices

Cable requirements Different cables are required for various devices.

Restrict cable length to less than 150m for Rs-485/422 devices and 15m for RS-232 devices to avoid communications problems.

Caution The display will give a prompt of “PLC no response...” for each communications fault until the communication resumes normal. The COM indicator on the front panel will light up in each communication.

Caution! Do no insert or pull out the cable while the power is on. Shielded cables must be used for long lengths or cables run in an electrically noisy environment.

Do not run cables next to AC power lines or near sources of electrical noise. Be sure that the cable ends have been inserted all of the way into mating connectors and are secure.

Pin Designations Pin assignment of the 9-pin male, D-SUB, COM0. This port is used to connect the MT4000 series touch screens and provides RS-232/485/422 port controller.

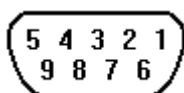

COM0

Note: This port is used for MT4000 programming and debugging at the same time.

Pin #	Signal	PLC [RS-485] 4 wire	PLC [RS-485] 2 wire	PLC [RS-232]	PC[RS-232]
1	Rx- (A)	RS-485 Rx	RS485A		
2	RxD_PLC			RS-232 Rx	

3	TxD_PLC			RS-232 Tx	
4	Tx-	RS-485 Tx			
5	GND	Signal ground			
6	Rx+(B)	RS-485 Rx	RS485B		
7	RxD_PC				RS-232 Rx
8	TxD_PC				RS-232 Tx
9	Tx+	RS-485 Tx			

Pin Designations

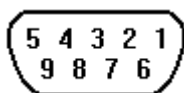

Pin assignment of the 9-pin female, D-SUB, COM1. This port is used to connect the MT4000 series touch screens and provides RS-232 port controller.

Pin assignment of this port is basically the same as COM0. The only difference is that COM0 is connected with the RS-232 interface of the PC to serve as the hardware flow control signal for PLC-232 connection.

COM1

Pin #	Signal	PLC [RS-485] 4 wire	PLC [RS-485] 2 wire	PLC [RS-232]
1	Rx- (A)	RS-485 Rx	RS485A	
2	RxD_PLC			RS-232 Rx
3	TxD_PLC			RS-232 Tx
4	Tx-	RS-485 Tx		
5	GND	Signal ground		
6	Rx+(B)	RS-485 Rx	RS485B	
7	CTS_PLC			Clear to send input
8	RTS_PLC			Ready to send output
9	Tx+	RS-485 Tx		

2.3.2 Connection with PC

The COM0 port on the back of the case can be used to connect PLC RS-232/485/422 devices and can also be used to connect with the programming interface and setting interface of a PC.

Connection The port can be connected to a PC through a dedicated cable (P/N: MT4000-PC).

Port Function Due to the reason of communication rate, the COM0 port of a PC is only used for

configuration downloading and parameter setting, and it will not be used for indirect online simulation.

Pin Pin assignment of 9-pin, male, D-SUB COM0

Designations

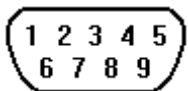

Pin #	Signal	PLC [RS-485] 4 wire	PLC [RS-485] 2 wire	PLC [RS-232]	PC[RS-232]
1	Rx- (A)	RS-485 Rx	RS485A		
2	RxD_PLC			RS-232 Rx	
3	TxD_PLC			RS-232 Tx	
4	Tx-	RS-485 Tx			
5	GND	Signal ground			
6	Rx+(B)	RS-485 Rx	RS485B		
7	RxD_PC				RS-232 Rx
8	TxD_PC				RS-232 Tx
9	Tx+	RS-485 Tx			

MT4000 -RS232/485/422-PC PLC RS232/485/422 PC RS232

**MT-4000 to PC
MT4000_PC
Wiring
Diagram**

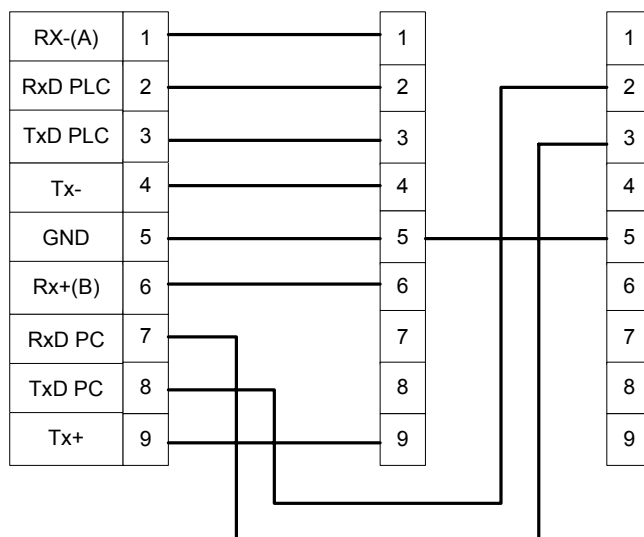

2.3.3 USB Connection

The USB port on the back of the case is the USB Slave device used to connect with a PC for configuration downloading and HMI setting. It cannot be used to connect with peripheral equipment such as a USB printer.

Connection USB Slave port can be connected with a PC through a general USB cable.

Port Function The port is only used to download user configuration program to the HMI and to

set HMI system parameters.

Port Diagram

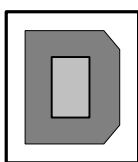

2.3.4 Connection with Printer

The parallel printer port on the back of the case can be used to connect with various parallel port printers on the market.

The full series of MT4000 products support printout function. The printing port will export data when the printing component works.

Printout

The MT4000 series touch screens support multiple printers with parallel ports, and eView HMItek Ltd. will continuously provide drivers for various brands of printers.

Note: The length of the connection cable of a printer shall not exceed 5m.

Pin Designations

Pin assignment of 15-pin, D-SUB, female, parallel printer port

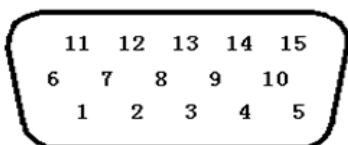

PRINTER

Pin#	Signal	Function	Pin#	Signal	Function
1	GND	Signal ground	13	DATA1	Output
2	DATA6	Output	14	INIT	Output
3	DATA3	Output	15	nERROR	Output
4	DATA0	Output			
7	DATA5	Output			
8	DATA2	Output			
10	BUSY	Input			
11	DATA7	Output			
12	DATA4	Output			

2.3.5 DIP Switch

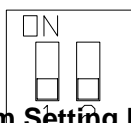

- **System Setting Mode:** In this mode, the touch screen will start a built-in system setting interface, where the user can set such parameters as IP address, brightness, contrast, and buzzer.

SW1	SW2	Working Mode
ON	ON	System Setting
OFF	ON	Touch Screen Calibrate Mode
ON	OFF	Firmware Update and Basic Parameter Setting Mode
OFF	OFF	Application (Online Operation) Mode

- **Touch Screen Calibrate Mode:** In this mode when you touch the screen, the screen will display a “+” sign, through which you can calibrate the touch accuracy of the screen.
- **Firmware Update and Basic Parameter Setting Mode:** In this mode the user can update firmware, set IP address, and perform other lower-level operations. In general, do not use this mode.
- **Application (Online Operation) Mode:** This is the normal working mode of MT4000 series touch screens. The screen will display the starting picture of the downloaded project.

2.4 CE Requirements

MT-4000 series of touch screens conform to the following CE specifications:

- EMC Directive (89/336/EEC, 92/31/EEC, 93/68/EEC) electromagnetic emissions and immunity
- Machinery Directive (89/392/EEC, 91/368/EEC, 93/44/EEC, 93/ 68/EEC) machine safety
- MT4000 series products will be CE-marked to indicate compliance with the EMC Directive

The MT4000 series has been designed to operate satisfactorily in electromagnetic noise (immunity) and without emitting high levels of electrical noise into the environment (emission). The units are designed to meet European Community standards when installed per the wiring instructions in this manual.

The MT4000 series touch screens have been designed to meet electromagnetic compatibility for industrial environments.

Compatibility Standards

- CISPR (EN 55011) Group 1, Class A Radiated Emission levels
- EN61000-6-4/2001, Generic standards – Emission standard for industrial environments
- EN61000-6-2/2001 Immunity for Industrial Environments
- EN61000-4/-2/-3/-4/-5/-6 Electrostatic discharge, electrostatic field immunity test, electrical fast transient/burst, surge immunity test, immunity to conducted disturbance

3. Programming Software

Programming Software	EV 5000 V1.0.0 or later
----------------------	-------------------------

4. Product Specifications

MT4300 Basic Parameters

Model	4300L	4300S	4300C	4300T
Case color	Black			
Display	5.7STN	5.7CSTN	5.6TFT	5.7TFT
Resolution	320×240			
Brightness	200cd/m ²	200 cd/m ²	300 cd/m ²	350 cd/m ²
Color	256 grey scale	64K color	64K color	64K color
Backlight	1CCFL	1CCFL	1CCFL	1CCFL
Touch screen	4-wire precision resistance network			
CPU	200M~400MHz RISC			
Memory	8M FLASH, 16M SDRAM			
COM port	Two RS/232/485/422, one USB SLAVE			
Recipe memory	256K WORD			
Printer port	1 DB15			
General specifications				
Power supply	21~28VDC working current Max 400mA @ 24V starting current Max 600mA @24V			
CE certification	Complies with EN61000-6-4/2001: EN55011, EN61000-6-2/2001, EN61000-4-2/-3/-4/-5/-6 standard			
FCC compatibility	Complies with FCC Class A			
Dielectric strength test	500 VAC 1 minute			
Insulation resistance	Greater than 50M Ω@ 500V DC			
Shockproof test	10~25Hz (X, Y, Z direction, 2G, 30 minutes)			
Degree of protection	IP65 (front panel)			
Operating temperature	0~45			
Operating humidity	10~90% non-condensing			
Case materials	ABS			
Dimensions	204×150×52mm			
Dimensions of installation holes	192×138mm			
Weight	0.85kg			
Cooling method	Natural air cooling			

MT4300 Dimensional Drawing

Unit: mm (inch)

Front View

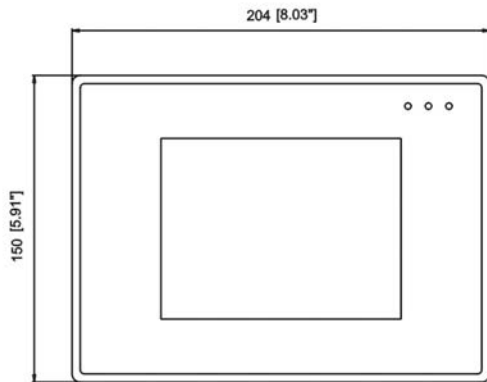

Side View

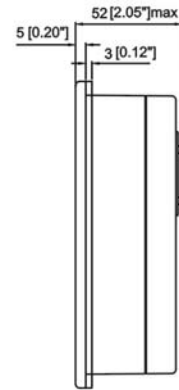

Top View

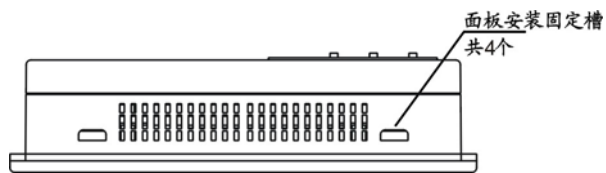

Rear View

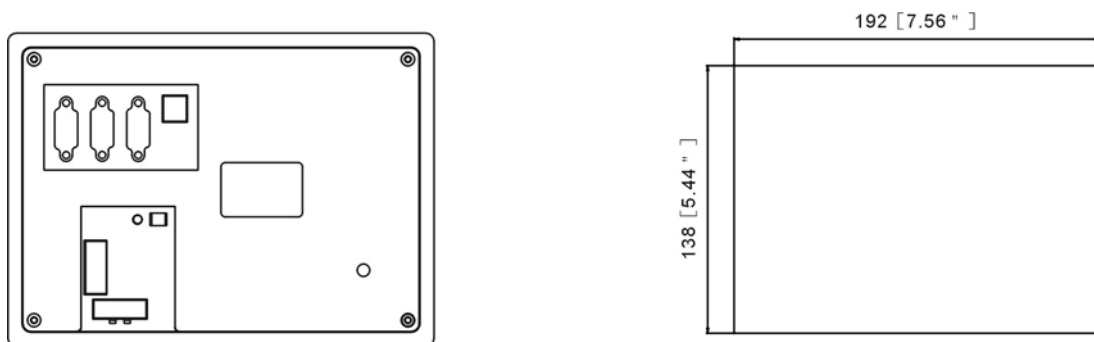

4400T Basic Parameters

Model	4400T
Case color	Black
Display	8" TFT
Resolution	640×480
Brightness	350 cd/m ²
Color	64K color
Backlight	1CCFL
Touch screen	4-wire precision resistance network
CPU	200MHz RISC
Memory	8M FLASH, 16M SDRAM
COM port	2 RS/232/485/422, 1 USB SLAVE
Recipe memory	128K WORDS
Printer port	1 DB25
General specifications	
Power supply	21~28VDC working current Max 400mA @ 24V starting current MAX 600mA @24V
CE certification	Complies with EN61000-6-4/2001: EN55011, EN61000-6-2/2001, EN61000-4-2/-3/-4/-5/-6 standard
FCC compatibility	Complies with FCC Class A
Dielectric strength test	500 VAC 1 minute
Insulation resistance	Greater than 50MΩ @ 500V DC
Shockproof test	10~25Hz (X, Y, Z direction, 2G, 30 minutes)
Degree of protection	IP65 (front panel)
Operating temperature	0~45
Operating humidity	10~90% non-condensing
Case materials	ABS
Dimensions	235×172×53 mm
Dimensions of installation holes	224×161 mm
Weight	1.1kg
Cooling method	Natural air cooling

MT4400 Dimensional Drawing

Unit: mm (inch)

Front View

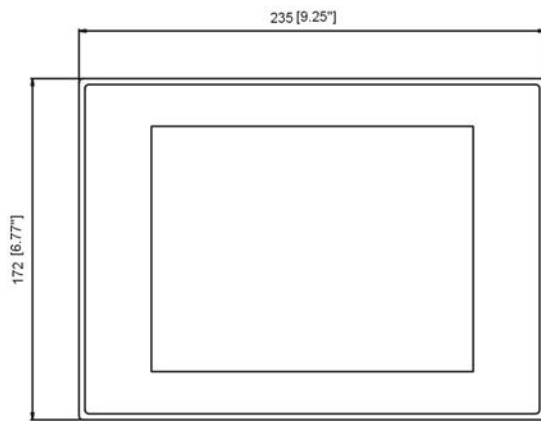

Side View

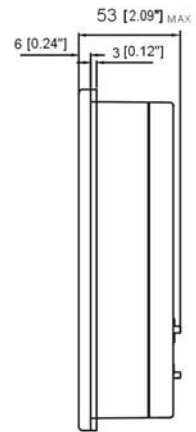

Top View

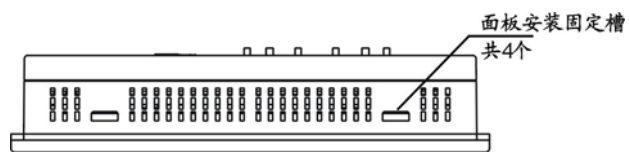

Rear View

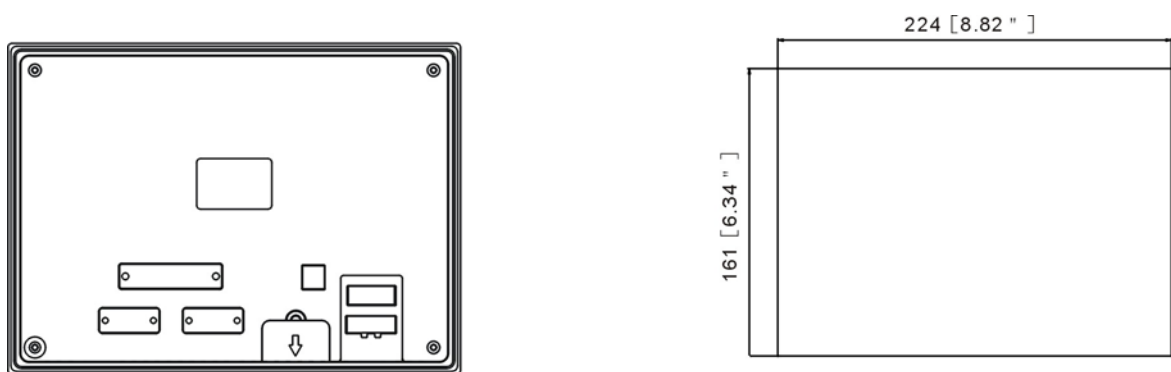

MT4500 Basic Parameters

Model	4500L	4500T
Case color	Dark grey	
Display	10.4STN	10.4TFT
Resolution	640×480	
Brightness	100 cd/m ²	350 cd/m ²
Color	256 grey scale	64K color
Backlight	1CCFL	2CCFL
Touch screen	4-wire precision resistance network	
CPU	200MHz RISC	
Memory	8M FLASH, 16M SDRAM	
COM port	2 RS/232/485/422,1 USB SLAVE	
Recipe memory	256K WORD	
Printer port	1 DB25	
General specifications		
Power supply	21~28VDC working current Max 400mA @ 24V starting current Max 600mA @24V	
CE certification	Complies with EN61000-6-4/2001: EN55011, EN61000-6-2/2001, EN61000-4-2/-3/-4/-5/-6 standard	
FCC compatibility	Complies with FCC Class A	
Dielectric strength test	500 VAC 1 minute	
Insulation resistance	Greater than 50MΩ @ 500V DC	
Shockproof test	10~25Hz (X, Y, Z direction, 2G, 30 minutes)	
Degree of protection	IP65 (front panel)	
Operating temperature	0~45	
Operating humidity	10~90% non-condensing	
Case materials	ABS	
Dimensions	310×230×54 mm	
Dimensions of installation holes	298×218 mm	
Weight	1.67kg	
Cooling method	Natural air cooling	

MT4500 Dimensional Drawing

Unit: mm (inch)

Front View

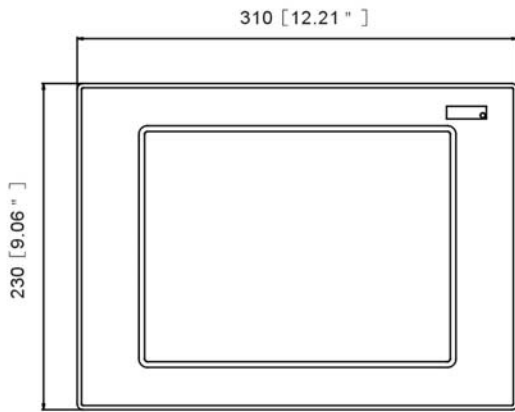

Side View

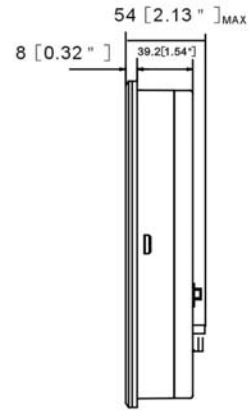

Top View



Rear View

